

DATA ACQUISITION SYSTEM

Omniace

RA2300MKII/RA2300MKII-S

RA2800A

Measurement by Anyone, Anywhere



RA2300MKII (HDD model)
RA2300MKII-S (SSD model)

RA2800A

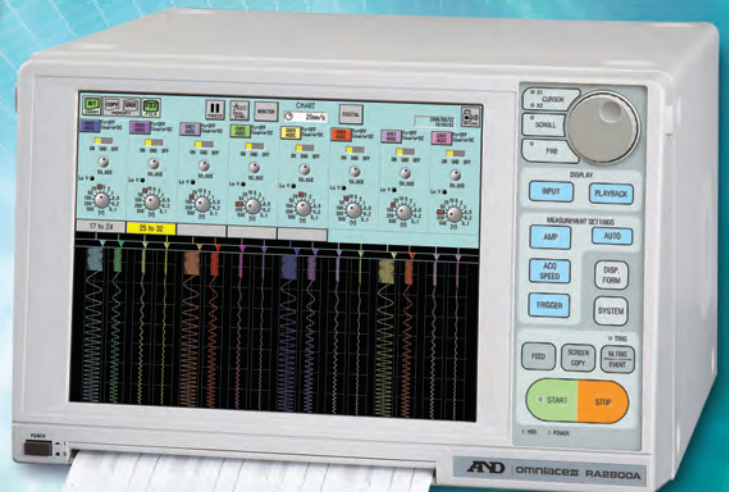

- Easy Data Recording
- Long-term Recording on Built-in HDD/SSD

SSD: Solid state drive



■ RA2300MKII



■ RA2800A

The RA2300MKII(-S)/RA2800A Omnicore is a data acquisition device that enables you to acquire/record data with simple operation. Reduced condition setting time and easy measurement can be realized by virtual amplifier settings, a touch-panel and dynamic waveform display on a large LCD. The RA2300MKII(-S)/RA2800A features with various measuring modes such as HD Recorder (for long-term recording on an internal HDD*) or Memory Recorder (for fast-speed event recording).

Direct sensor inputs up to 32 channels (16 slots) are available for RA2800A and 16 digital input channels measure diverse signal timing and contact status.

The RA2300MKII(-S)/RA2800A will bring you success in many measuring opportunities such as production line, quality inspection and R&D.

*1 RA2300MKII:160GB (HDD model) / RA2300MKII-S:256GB (SSD model) / RA2800A:40GB (HDD model)

FEATURES

■ Easy pen recorder mode

Easy operation of the "pen recorder" was realized by virtual amp. setup display and touch panel. Easy measurement of a "pen recorder" is yours without complicated settings.

■ Various features at playback mode

Various search functions are available for finding certain points in large data easily after long-term recording. Fast search using a thumbnail bar (displays all recorded data of selected one channel) and jump search (max/min, time, etc.) available.

■ Improved vibration resistance (RA2300MKII-S)

The RA2300MKII-S can withstand transportation in vehicles with rigid suspension as well as the harsh environmental conditions on land and sea transport. (satisfies 2G requirement)
Standard: IEC60068-2-64

■ Display input waveform on a large screen

A large 12.1" LCD for better visibility of measured data. Horizontal and vertical waveform scroll is selectable for RA2800A and this function increases visibility.

■ Long-term HDD recording

Long-term & high speed data recording direct to internal HDD/SSD.

■ Standard LAN & USB ports

LAN (100BASE-TX) for data communication and USB for external storage devices (USB memories) are standard interfaces.

■ Computation · FFT unit equipped standard (RA2300MKII-S)

Perform four arithmetic operations, interval statistical calculation, function operation and FFT analysis.

Supporting Measurement at Various Fields (Operation & Displays)

Dynamic Waveform Display

This system has large 12.1 inch LCD and shows dynamic waveforms. Displaying number and dividing waveforms are voluntarily setttable so that various waveforms to every application are available.

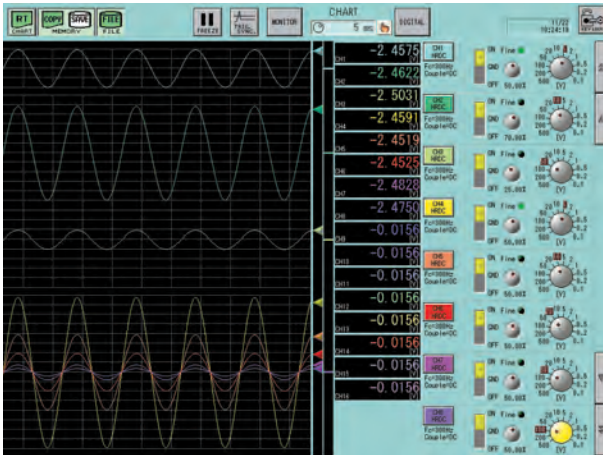

RA2300MKII(-S) Numerical value + amp setup display

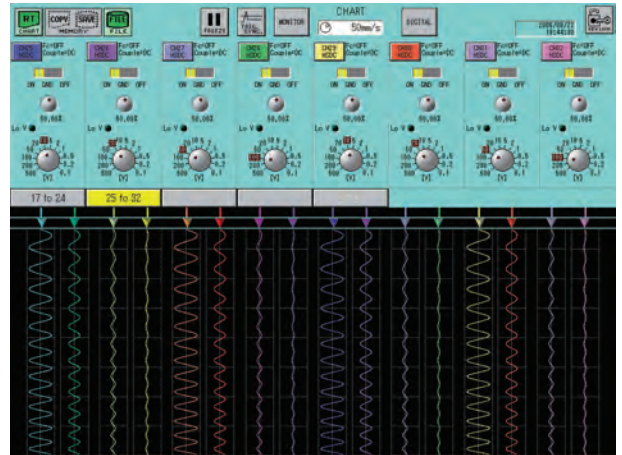

RA2800A Image of divided waveforms and vertical scroll

Easy Operation with Rich Features

Setup displays with virtual mechanical switch or jog dial allows users to understand input amplifier settings easily. By using both 12.1" large LCD and the touch panel, measuring conditions can be modified while monitoring waveforms at the large display. The input amplifier can also be automatically tuned by "auto" button on actual operational panel.

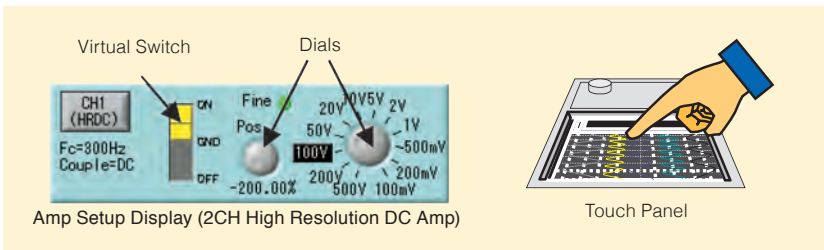

Amp Setup Display (2CH High Resolution DC Amp)

Touch Panel

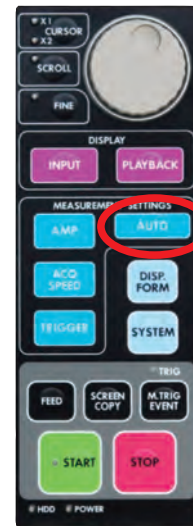

"Auto" button

Operation Panel

Direct Input from Sensors



AP Amp Series

11 types of AP amplifiers including voltage, temperature, strain, vibration and frequency (pulse) are available and they enable every signal to direct input.

Item	Model No	Model No	Resolution	Description
2-CH High Resolution DC Amp	AP11-101	10μs	16-bit	DC amp for high resolution measurement
2-CH High Speed DC Amp	AP11-103	1μs *1	12-bit	DC amp for high speed measurement
2-CH Zero Suppression Amp	AP11-111	10μs	16-bit	DC amp for gaining signal changes by eliminating offset element of input signals
2-CH FFT Amp	AP11-102	10μs	16-bit	DC and vibration amp to prevent high frequency loop-back
Event Amp	AP11-105	1μs *1	N/A	Amp for recording open/close for contact or H/L for voltage
2-CH TC/DC Amp	AP11-106A	10μs	15-bit	Input amp for thermocouple (R, T, J, K and W) and voltage
2-CH AC Strain Amp	AP11-104A	10μs	16-bit	Strain amp which reduces influence of external noises (AC bridge system)
2-CH DC Strain Amp	AP11-110	10μs	16-bit	Strain amp with DC bridge system
2-CH Vibration/RMS Amp	AP11-109	10μs	16-bit	DC/vibration amp for measuring signals in RMS
F/V Converter	AP11-108	10μs	16-bit	Amp for converting frequency (pulse) into voltage
TC/DC Amp	AP11-107	10μs	14-bit	1-ch input amp for thermocouple (R, T, J and K) and voltage

*1 2 μs for RA2800A

User Selectable Measuring Modes

Users can easily select from five (5) Measurement Modes - Pen Recorder mode for real time strip chart recording, HD Recorder mode for long term recording of data to a HDD, X-Y Recorder mode for displaying/recording X-Y correlation of two signals, a Multi Recorder mode captures transients while recording steady-state signals, and a Memory Recorder mode for recording fast events.

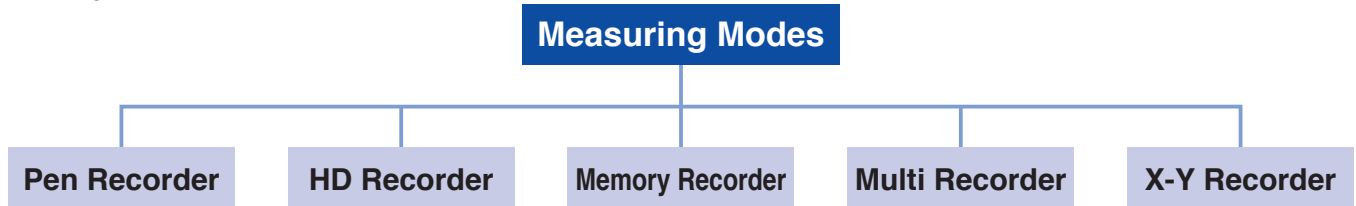

Easy “Pen Recorder”

The “Pen Recorder” is a measuring mode with simple operation of pen recorders. The waveforms are displayed with “moving nib” images. Also, like pen recorders, amplifier and paper feeding speed* can be setup on the touch panel.

*RA2300A chart speed : 100mm/s ~1mm/min RA2800A chart speed : 50mm/s ~ 1mm/min

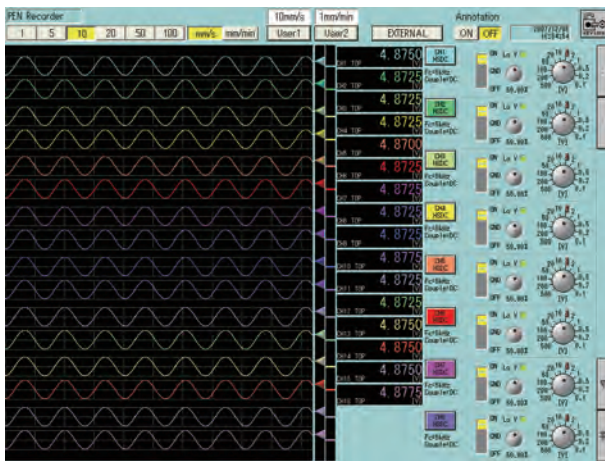

RA2300MKII(-S) display sample

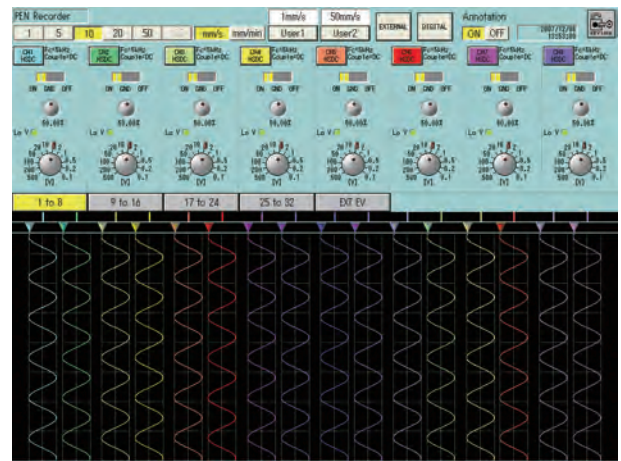

RA2800A vertical display sample

“HD Recorder”: Best for Long-term Recording

Patented: Patent No. 3586801

Long-term data recording is available on a standard built-in HDD/SSD *1.

Since data is digitally saved, post-record analysis or long-period management of data, which is not an option for recording paper, is possible.

High speed recording can be done at 1 μ s on 1 channel and at 10 μ s over 16 channels with the RA2300MKII(-S) and at 2 μ s on 1 channel and at 20 μ s over 32 channels with the RA2800A.

Sample or peak style is selectable in recording.

Peak style enables to have faster sampling data with max/min value than recording interval so that it can record data in slow recording interval.

*1 Real data recording capacity (excludes area used by system)

RA2300MKII : Approx. 148GB / RA2300MKII-S : Approx. 240GB / RA2800A : Approx. 35GB

Recordable Time on Hard Disk*2

Sampling Speed	2 GB Capacity*5			35 GB Capacity		
	w / 1 channel	w / 16 channels	w / 32 channels*4	w / 1 channel	w / 16 channels	w / 32 channels*4
*3 1 μ s	16.7 min	N/A	N/A	4.86 hrs	N/A	N/A
2 μ s	33.3 min	N/A	N/A	9.72 hrs	N/A	N/A
5 μ s	1.39 hrs	N/A	N/A	24.3 hrs	N/A	N/A
10 μ s	2.78 hrs	10.4 min	N/A	2.03 days	3.04 hrs	N/A
20 μ s	5.56 hrs	20.8 min	10.4 min	4.05 days	6.08 hrs	3.04 hrs
50 μ s	13.9 hrs	52.1 min	26.0 min	10.1 days	15.2 hrs	7.59 hrs
100 μ s	1.16 day	1.74 hrs	52.1 min	20.3 days	1.27 day	15.2 hrs
200 μ s	2.32 days	3.47 hrs	1.74 hrs	40.5 days	2.53 days	1.27 day
500 μ s	5.79 days	8.68 hrs	4.34 hrs	101 days	6.33 days	3.17 days
1 ms	11.6 days	17.4 hrs	8.68 hrs	203 days	12.7 days	6.33 days
2 ms	23.1 days	1.45 day	17.4 hrs	405 days	25.3 days	12.7 days
5 ms	57.9 days	3.62 days	1.81 day	1013 days	63.3 days	31.7 days
10 ms	116 days	7.23 days	3.62 days	2026 days	127 days	63.3 days

*2 It's a calculated value by integral number in sampling filing. Recording time will be half in peak filing.

*3 Sampling speed 1 μ s is available for RA2300MKII(-S) only.

*4 32ch is available for RA2800A only.

*5 Recording data is saved by every 2 GB for file protection. (in case recording data is set over 2GB)

Memory Recorder: For Fast Event Recording

This mode is for recording fast events with internal memories*1. Unused memories can be utilized, so maximum of 32MW is available for memory recording if used only one channel. Measurements under various conditions are also possible by using many trigger functions.

*1 RA2300MKII(-S) memory : fastest 1μs by 2MW/CH RA2800A memory : fastest 2μs by 1MW/CH

Trigger Mode

OR : Activates if signal of ANY selected channel reaches trigger level.

AND : Activates if signals of ALL selected channels reach trigger level.

WINDOW : ... Activates if signal of selected channel(s) reaches preset level (IN) or gets out of it (OUT).

Pre-trigger (Memory recorder mode only)

Data before the trigger point can be recorded to memory. Data can be recorded before and after the trigger point which is set as a percentage of the full memory capacity of the block. The example below shows the pre-trigger set to 25%. In this case data before the trigger event will be saved to 25% of the memory capacity of the block.

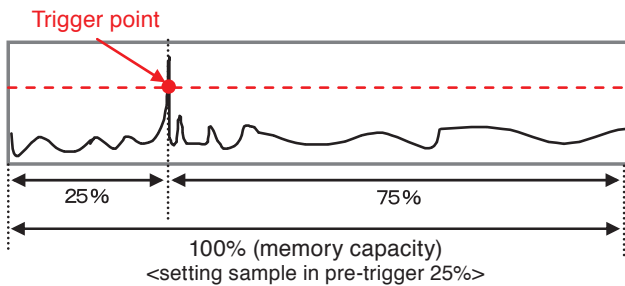

Memory Block

As memory blocks are segmented, recording time is segmentalized and several recording functions are repeatable.

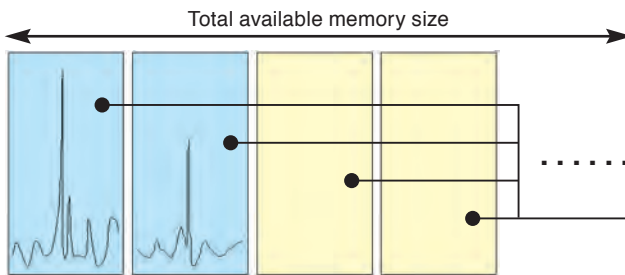

Recordable Time on Memories*2

Sampling Speed	w / 1 ch	w / 16 chs	w / 32 chs*3
*2 1μs	33.6 sec	2.10 sec	N/A
2μs	1.12 min	4.19 sec	2.10 sec
5μs	2.80 min	10.5 sec	5.24 sec
10μs	5.59 min	21.0 sec	10.5 sec
20μs	11.2 min	41.9 sec	21.0 sec
50μs	28.0 min	1.75 min	52.4 sec
100μs	55.9 min	3.50 min	1.75 min
200μs	1.86 hrs	6.99 min	3.50 min
500μs	4.66 hrs	17.5 min	8.74 min
1 ms	9.32 hrs	35.0 min	17.5 min
2 ms	18.6 hrs	1.12 hrs	35.0 min
5 ms	1.94 day	2.91 hrs	1.46 hrs
10 ms	3.88 days	5.83 hrs	2.91 hrs
100 ms	38.8 days	58.3 hrs	29.1 hrs

*2 Sampling speed 1μs is available for RA2300MKII(-S) only.

*3 32ch is available for RA2800A only.

What are sample data and peak data?

When measuring data with the RA2000 series, you can select from the recording data format used by most recording devices (sample data) and a format that samples data at high speed and records significant points (peak data). When recording with peak data, you can record high frequency noise regardless of paper feed speed. An example of the sample data and peak data recording formats at 10 ms sampling is shown below.

Sample data format

Data is recorded every 10 ms (designated recording speed). This method faithfully records the raw data every 10 ms.

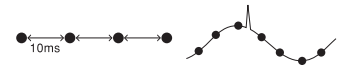

Peak data format

Sampling is performed at the maximum sampling speed over the set recording interval (10 ms is this case) and the maximum and minimum values are recorded. This allows compression of data without losing peak values. Peak data requires twice the recording capacity.



Memory blocks are segmented by 1, 2, 4, 8, 16, 32, 64, 128.

Multi Recorder: Records Steady-state & Transient Events Simultaneously

Chart printing, and recording to HDD and Memory can be simultaneously performed in this mode. A steady-state signal can be printed or recorded on the HDD while the system captures high-speed transient events to memory.

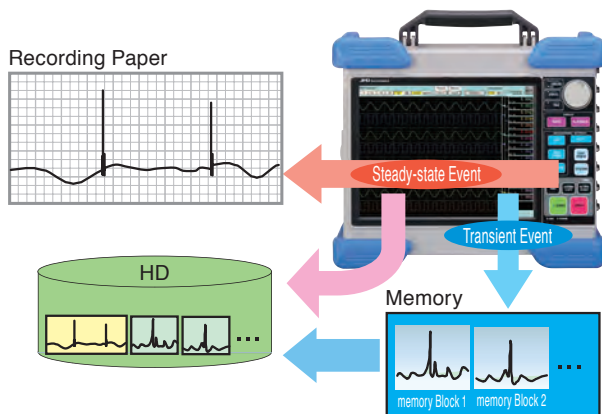

X-Y Recorder: Displays Correlation of Two Physical Values

Select any channel as the X input and up to 3 channels for the Y input. Signals are recorded and can be plotted for display and printing with high resolution (1600 x 1600 dots).

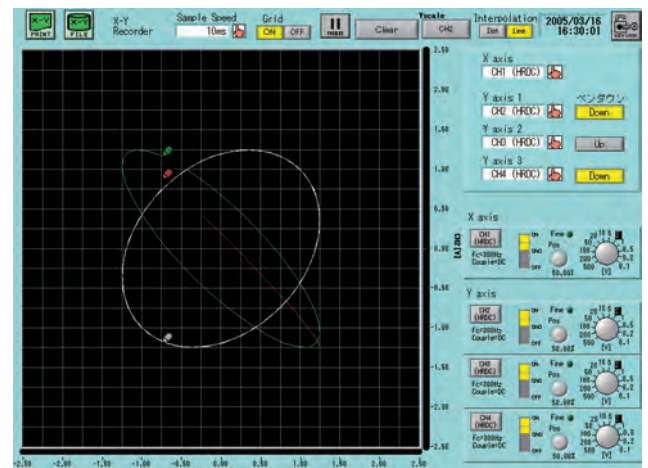

High Speed & High Resolution Recording

- High speed* and high resolution (80 dots/mm at 25mm/s) recording is available.
 - Customizable waveform division & printing size.
 - Location and amplitude of digital signals can be changed by 8 channels. Patented: Patent No. 3605738
- *Paper-feed speed of RA2300MKII(-S) is max 100mm/s and that of RA2800A is max 50mm/s.

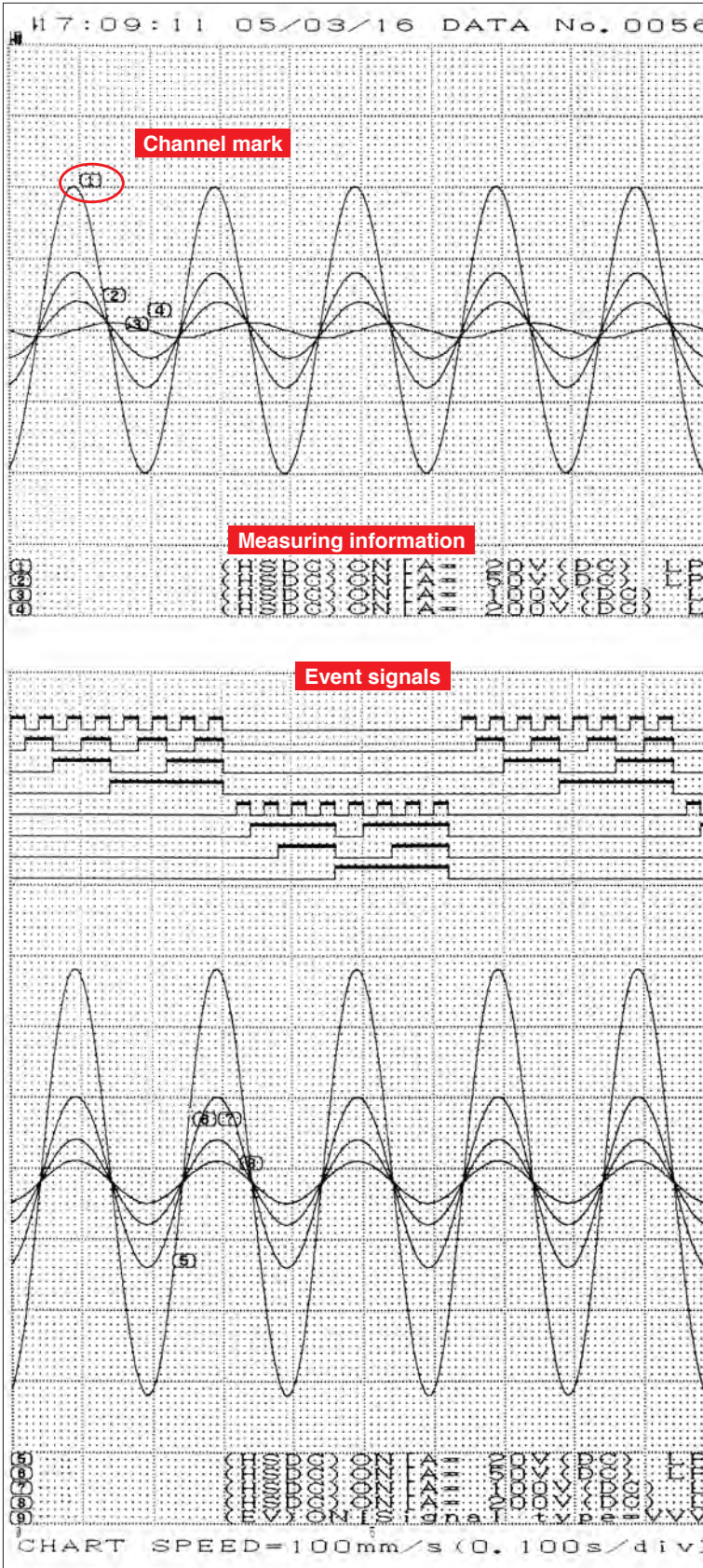

● Auto Scaling

Scales can be printed after waveforms.

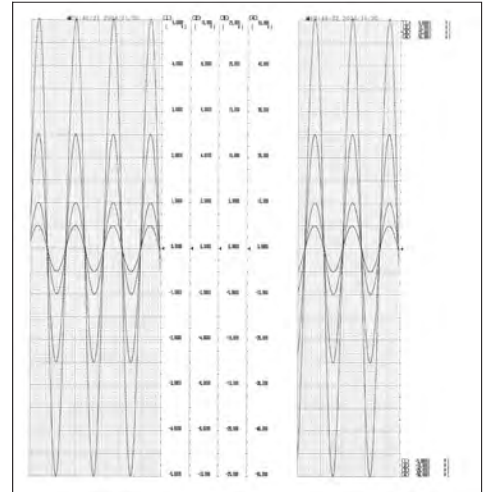

● Waveform Division

One to sixteen divisions can be selected to display or print out.

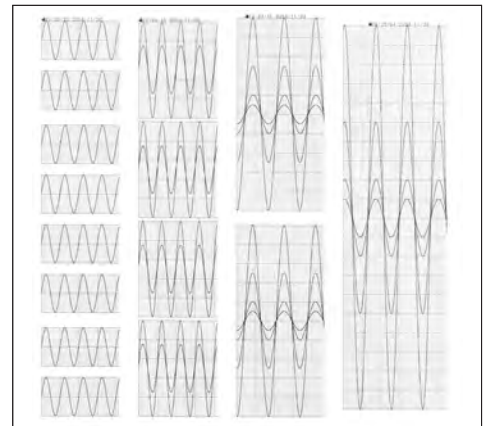

● Customizable Width Size

Users can print waveform at selected width (10 mm to 200 mm).

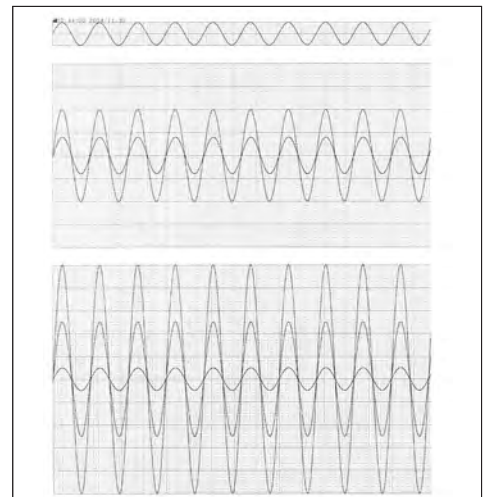

Various Features (Replay Monitor)

Easy Search of Large Data

Below functions are available for searching long-term and large data easily.

Thumbnail Bar :

This function displays a waveform image (one selected channel) of recorded data on a thumbnail bar. It does not only allow users to see whole waveform image easily but to get enlarged by touching.

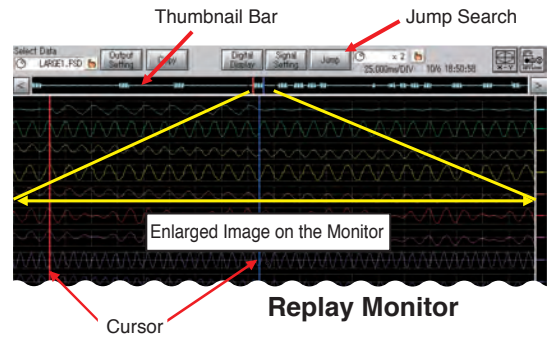
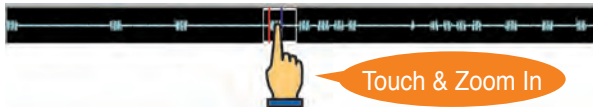

Four Jump Search Modes

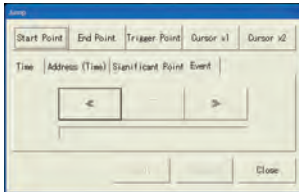

■ **Event...**
Move to marked event

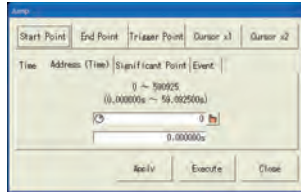

■ **Address (Time)...**
Move to elapsed time from start



■ **Max/Min...**
Move to max/min of recorded data

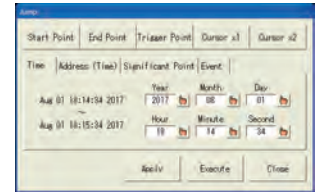

■ **Time...**
Move to specified time

Useful Functions

Level Cursors

Two level cursors that move on the voltage axis are shown on the waveform monitor and display the measurement level of that position. You can also display the difference between the cursor levels as ΔY .

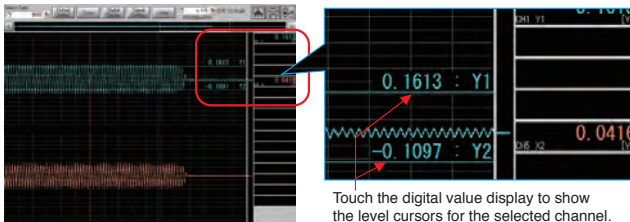

Cursor Calculations

View the maximum, minimum and average values for the area between the time axis cursors on the Replay monitor. Calculations update dynamically as the cursor is moved.

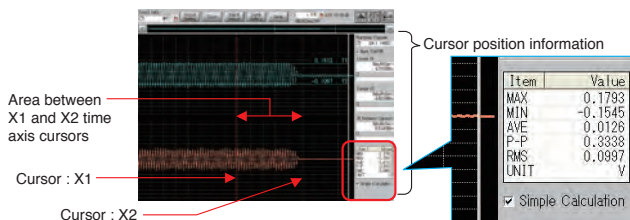

Timer-control Function

Automatic measurement with preset time and interval.

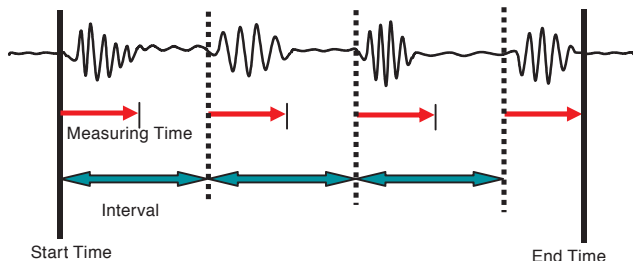

File Conversion to Support Analysis

Convert files to CSV for processing measurement data with spreadsheet or analysis software.

The RA2000 series has functions to compress and convert measurement data.



Analysis software*1 Direct conversion for MATLAB, FAMOS, DIAdem is possible.

1. Converting data from the Playback Screen

You can specify the range to convert while looking at the base waveform.

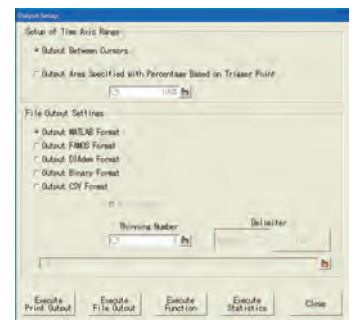

2. Converting data from the File Operation Screen

Convert data from the File Operation screen accessed by the System key. You can even convert multiple files at once.

*1 File Converter can be installed to the RA2000 series to convert data for analysis software. You can download this program from our homepage.



Options and Utilities

Remote Control by PC Software - Unifizer NS3000 Series

This PC application software enables the user to remotely program set-up configurations, record data, make arithmetic computations, and analyze data.

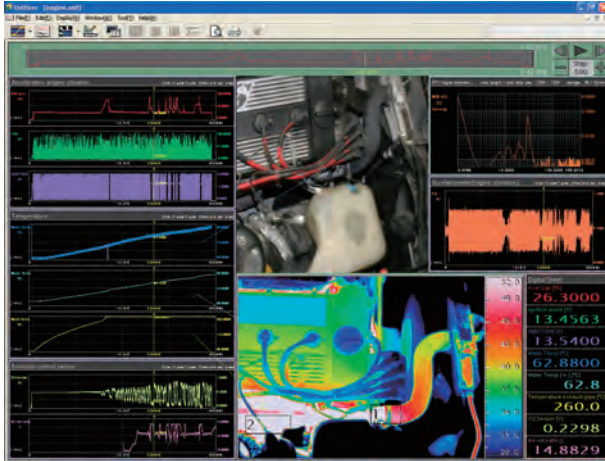

Remote Control Feature

Remotely control all RA series units via Ethernet. Control mainframe data acquisition functions, signal conditioning amplifiers, IR thermal imager and NEC-ATI approved A/D boards and visible light cameras.

Multiple Mathematic Operations and FFT Analysis

Perform arithmetic operations, function operations and FFT analysis on real time and recorded data.

User Defined Monitor Display

Monitor display of Digital, Y-T & X-Y, and Bitmap data can be freely customized by user.

Report Generator and Simplified Print Feature

You can create comments and arrows freely on the waveform display screen and print the image as a report.

Up to eight (8) RA series units can be controlled by a single PC. The PC remotely controls measuring modes and data saving functions of each RA unit.

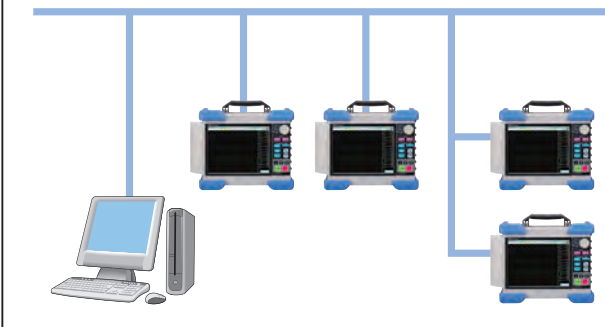

Images for reports can be easily prepared by printing added comments along with trace data and detected Max/Min and X/Y variation values.

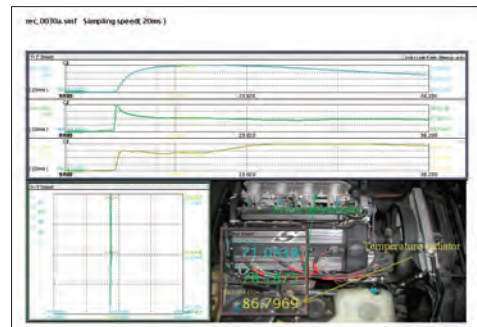

Expanded Option*1 (Arithmetic and FFT Unit: RA23-751)

The RA23-751 software computes math operations (arithmetic/trig/log/calculus and FFT analysis) on recorded channel data and displays the results in tabular, or waveforms in time axis and frequency form, and saves the results.

*1 Equipped standard on the RA2300MKII(-S)

Data Stored (Filed) in Memory

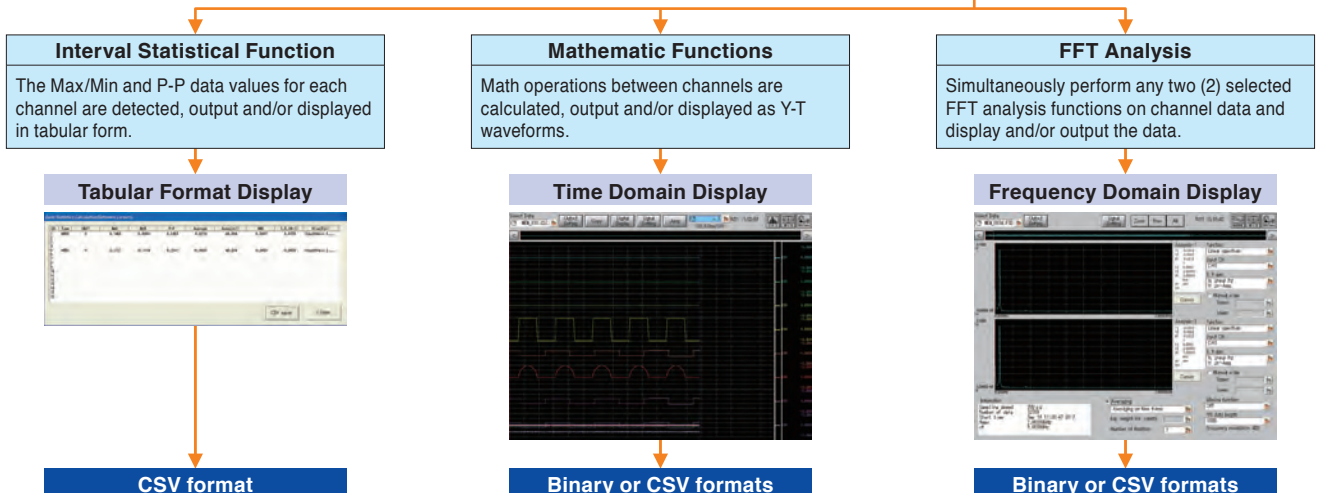

Multiple Unit Synchronization – Model RA28-132 (Model RA2800A units only)

The Model RA28-132 Synchronization option allows multi-channel memory recording among multiple connected Model RA2800A units. Up to 10 units can be daisy chain connected to expand channel capacity to 320 channels. One unit is a master and the others are slaves. All recorded data is time synchronized with the sampling clock of the master unit.

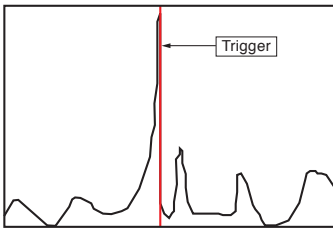
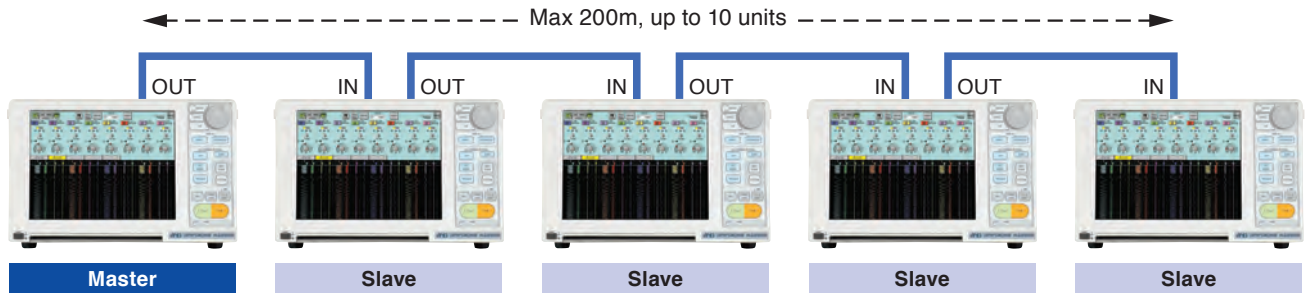

Master memory data sample

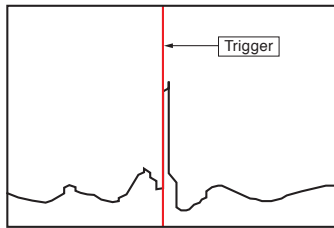

Slave memory data sample

The high speed, multi-channel time synchronized data recorded by the RA2800A master and slave units is also simultaneously triggered. The trigger signal to simultaneously start and end memory recording in all units can be generated by either the master or any slave unit.

The Unifizer Model 3000 series remote control software is recommended for multi-unit synchronization applications.

DIV Sensitivity Unit - Model RA28-112 (Model RA2800A units only)

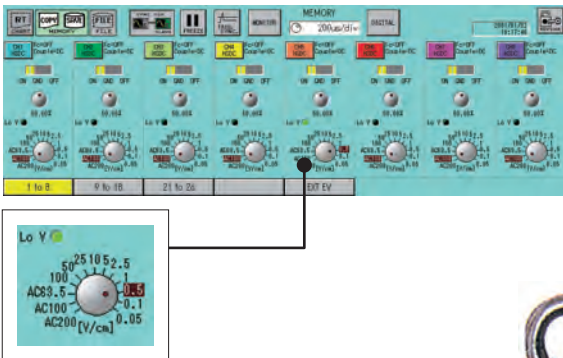

AC Voltage Level Detector 1540/1543

These external devices detect 100/120V & 220/240V voltage sags & surges exceeding selected 10% or 20% of AC peak value. A Model 1539 AC/DC Multi-Range Voltage Detector (not shown) that detects presence or absence of selected low or high voltages is helpful in determining system timing sequences. All detector outputs are ideal for use with all RA series recorder Event/Logic inputs.



The sensitivity of the LCD display and recording paper is controlled by conversion of the AC voltage RMS value for increased visibility and a feel that is similar to traditional electromagnetic oscillographs. In the AC200V/cm, AC100V/cm and AC63.5V/cm setting ranges, sensitivity is set so that the amplitude of the AC voltage (sine wave) RMS value is 1 cm. *If AC voltage is not an accurate sine wave the recording amplitude and RMS value will not match.

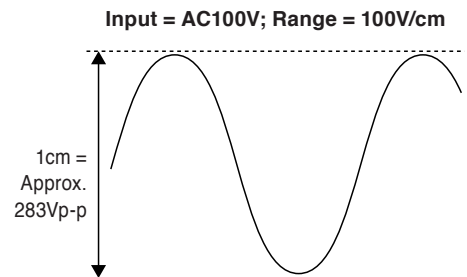

Unifizer LE for DAQ (PC application software)

Download Unifizer LE from the A&D homepage.

Use it to remotely control settings and data acquisition, perform calculations and analyze data on the RA2000 series.

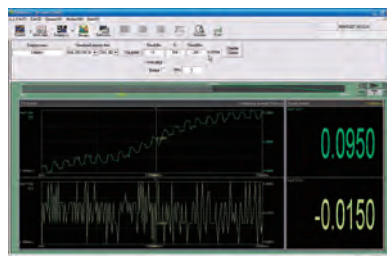
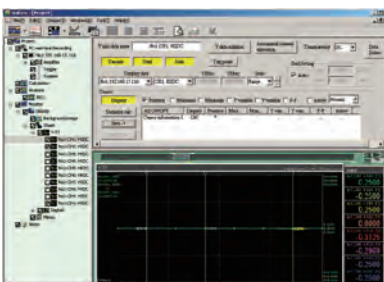

Connecting equipment

Remote operation of the RA2000 series is possible via Ethernet. You can also read data from an SD card.

Display customization

(1) Simultaneously display the recording screen and replay screen
You can display YT graphs, XY graphs, bar graphs, the numerical display, and bit map data in customizable layout on the data display window.

(2) Creating reports

You can create comments and arrows freely on the waveform display screen print the image as a report.

Calculation functions

Perform arithmetic operations, function operations and FFT analysis on real time and recorded data.

Input Unit Selection Block Diagram

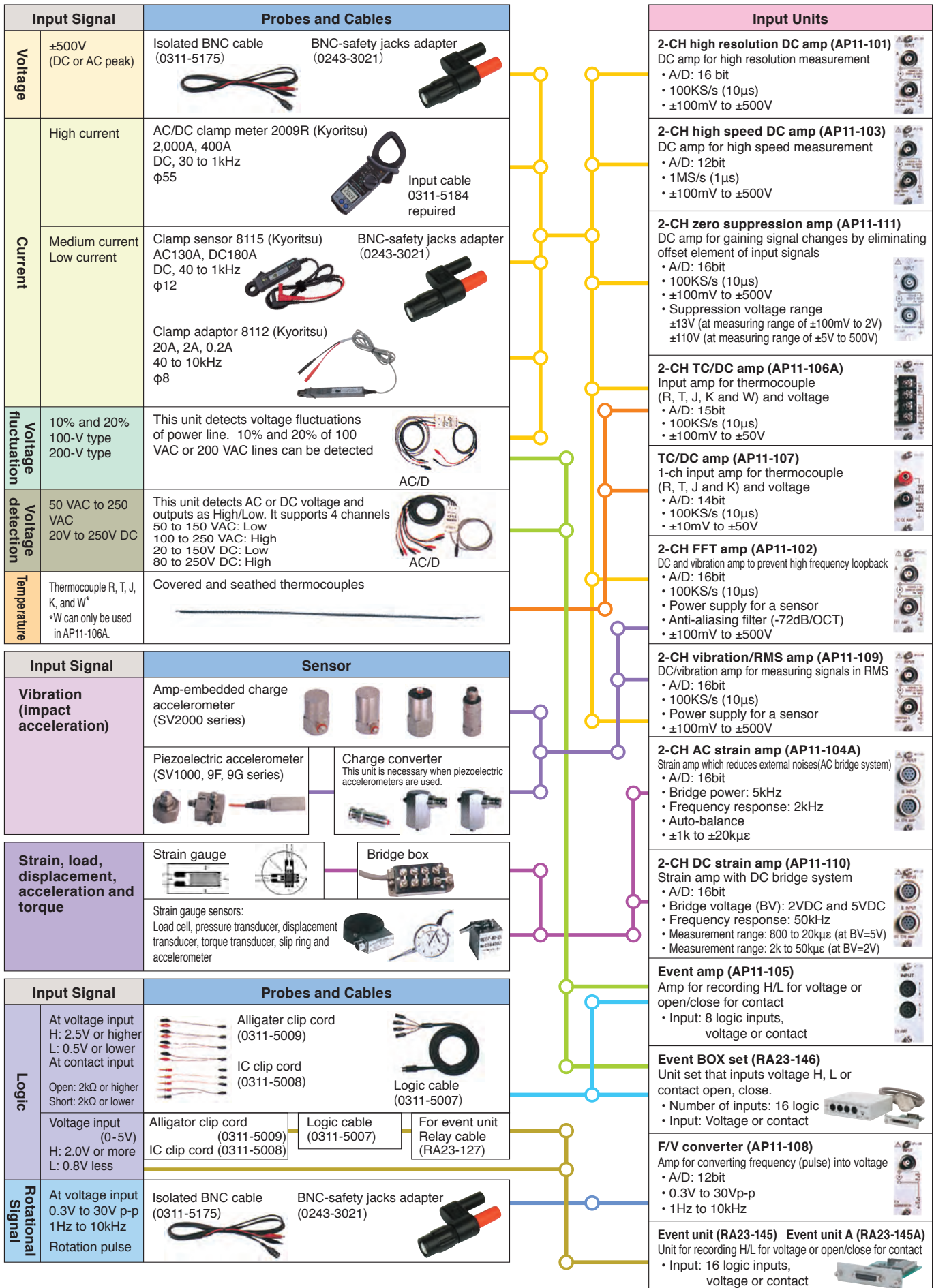

Basic Specifications

■ Basic Specifications

Display	12.1-inch TFT color LCD (1024 X 768 pixels)
Channel	RA2300MKII(-S) : 16ch (8 slots) + digital input 16ch (optional) RA2800A : 32ch (16 slots) + digital input 16ch (Built-in (Cable is optional))
Printer	
Printing Method	Thermal printing using a thermal head
Paper Width	219.5mm
Effective Recording Width	1 division (200mm • FS) to 16 division (10mm • FS), number of division and printing width can be changed.
Grid Pattern	10mm, 5mm, No grid
Battery Backup	RA2300MKII(-S) : Clock, Setting value: approx 3 to 5 years (using a primary battery) RA2800A : Clock, Setting value: approx 3 years (using a primary battery)
Storage Device	USB memory / RA2300MKII (160GB, HDD) / RA2300MKII-S (256GB, SSD) / RA2800A (40GB, HDD)
Interface	Ethernet (10/100 BASE-TX), USB standard *** Ethernet has basis over CAT5 (shielded) RS-232C, Remote terminal : optional
Compatible Specifications	EMC : EN1326 A1/A2/A3 Safety : EN61326
Operating Environment	Temperature: 5 to 40°C, Humidity: 35 to 80 %RH (without condensation)
Power Supply	100 to 240VAC, frequency 50 to 60Hz
Power Consumption	RA2300MKII(-S) : 100VA (typical) : with AP11-101 X 8 units (approx 300VA max) RA2800A : 170VA (typical) : with AP11-101 X 16 units (approx 350VA max)
Dimensions	RA2300MKII(-S) : W400 (±2.0) X H171 (±2.0) X D374 (±2.0) mm RA2800A : W400 (±3.0) X H270 (±2.0) X D380 (±3.0) mm excluding projections
Weight	RA2300MKII(-S) : 8.6kg or less (main body only), 9.4kg or less (main body with AP11-103 X 4 units) RA2800A : 16.4kg or less (main body only), 18.8kg or less (main body with AP11-103 X 16 units)

■ Communication & Storage Specifications

HDD	
Function	Setting conditions of main unit and save/read out of measured data
Capacity (Not including area used by the system)	RA2300MKII : Approx. 148GB / RA2300MKII-S : Approx. 240GB / RA2800A : Approx. 35GB
Ethernet	
Function	Control with communication command, Windows and file sharing with Windows PC
Standard	10/100 BASE-TX
USB	
Function	Data saving on storage device by USB connection, 2-port
Standard	2.0
Available Storage Device	USB memory (USB mouse usable)

■ Trigger Specifications

Trigger Mode	OR, AND, WINDOW, OFF
Trigger Source	Input signal, Manual trigger, External trigger
Trigger Settings	Amps other than Event Amp Trigger slope : OR, AND ... ↑ or ↓, WINDOW ... OUT or IN Level setting : To be set with physical values (e.g.voltage) Event Amp (AP11-105), main unit event (option for RA2300MKII(-S)) State setting : H, L, or OFF can be set for each input. When OFF is set, trigger condition is not applied. Trigger setting : AND or OR of state setting conditions of inputs from 1 to 8.
Trigger Related Functions	
Trigger Output	Output signal when trigger conditions are met (TTL Low active H-over 2V, L below 0.8V, Pulse width : approx 10ms)
Pre-trigger	0 to 100% (1% step)
Trigger Mark	Record trigger point with an arrow (↓) and print year, date and time trigger occurred.
Trigger Filter	1 to 65534 samples

■ Pen Recorder Specifications

Waveform Printing	
Function	Printout input signal data on recording paper (waveform)
Measurement Starting Operation	Start with pressing START key or preset time. Interval recording available.
Paper-feed Speed	RA2300MKII(-S) : 100 mm/s to 1 mm/min (user setting, external synchronization enabled) RA2800A : 50 mm/s to 1 mm/min (user setting, external synchronization enabled)
Frequency Response	DC to 100 kHz (sampling : 10 points/cycle). Varies by input unit
Printing Density	Voltage axis : 8 dots/mm, Time axis : 80 dots/mm (at 25 mm/s)

■ HD Recorder Specifications

Data Recording	
Function	Real-time recording of measured data on HDD/SSD (sample of peak style is selectable)
Recordable Size	Refer to data acquisition and communication specifications
Measurement Starting Operation	Start with pressing START key, trigger detection or preset time.
Sampling Speed	RA2300MKII(-S) : 1µs (w/1ch), 5µs (w/8ch), 10µs (w/16ch) max (user setting) RA2800A : 2µs (w/1ch), 10µs (w/16ch), 20µs (w/32ch) max (user setting)
Recording Method	Normal or Ring recording (repeated recording during preset time) selectable.
Waveform Printing (Refer to Pen Recorder spec)	
Function	Printout input signal data on recording paper (waveform)
Measurement Starting Operation	ON/OFF of printout to recording paper while HD recording

■ Memory Recorder Specifications

Data Recording	
Function	Record measured data on memory in main unit.
Measurement Operation	Once, Repeat, or Endless
Memory Capacity	RA2300MKII(-S) : 2MW/ch (w/16ch), 32MW/ch (w/1ch) RA2800A : 1MW/ch (w/32ch), 32MW/ch (w/1ch)
Memory Division	1, 2, 4, 8, 16, 32, 64 or 128 divisions
Sampling Speed	RA2300MKII(-S) : 1µs to 100s (user setting, external synchronization enabled) RA2800A : 2µs to 100s (user setting, Sampling is synchronized with RA28-132)
Waveform Printing	
Function	Printout input signal data on recording paper (waveform)
Printing Density	Voltage axis : 8 dots/mm, Time axis : 10 dots/mm
Copy Magnification	X 100 to X 1/10,000
Memory Filing	Data is saved on the memory device in binary or CSV format every time when it is stored in memories.
Data Backup	Memory backup with HDD (data saved in a specified area of HDD at shutdown)
Save / Copy Area	Copy with trigger at center : 1 to 100% (1% step), copy between two cursors.

■ Multi Recorder Specifications

Function	Steady-state and transient events can be recorded simultaneously on HD, memory and/or recording paper
Pen Recorder	Refer to Pen Recorder spec
HD Recorder	Refer to HD Recorder spec
Memory Recorder	Refer to Memory Recorder spec (waveform printing available)

■ Measuring Mode (Acquisition/Recording) Specifications X-Y Recorder

Function	ON/OFF of locas enabled (pen up & down) Input signal monitor, freeze, copy and X-Y display during data recording available.
Axis Setting	X-axis : 1 channel, Y-axis : 3 channels
Measuring Speed	1ms to 1s
Data Recording	
Function	Record all input signals (for channels with input ON in the amp setting display) on HD.
X-Y Waveform Printing (Printout)	
Function	Printout displayed waveforms (X-axis : 1ch, Y-axis : 3ch) at A4 size
Resolution	1600 X 1600 dots (at printout), 650 X 650 dots (at display)

■ Measured Data Display (Replay Monitor) Specifications

Function	Display recorded data at X-T or X-Y when pressed "Replay" button on operation panel.
Y-T Display	
Waveform Division	1 to 16 divisions
Display Magnification	X 100 to X 1/10,000 (** Peak style is not enlarged)
Thumbnail Function	Display whole data of selected one channel on a thumbnail bar
Numeric Display	Numeric value, cursor value, numeric + cursor values (by switching over)
Search Function	Search by cursor, time, address, max/min and event
X-Y Display	
Channels Allowed	Up to 1ch/X-axis and 3ch/Y-axis can be displayed (to be selected by user)
Data Output	On file and printing paper
Output File Format	Binary or CSV data

■ Output Specifications

Printer	
Data Information	Measuring mode, year/month/day, measurement start time, data No., trigger conditions (trigger type, trigger date, trigger time), sampling speed, paper speed, time axis can be printed with waveforms. ON/OFF selectable.
Channel Information	Print input unit settings when saved. ON/OFF selectable.
Mark Print	Pen-Recorder, HD-Recorder, mark (date/time) print
Screen Copy	Print screen image on recording paper
Line Width for Printing	Select base line boldness for each channel (1, 2, 3, or 4 dots)
Auto Function	
Function	By pressing "Auto" button on an operational panel, sampling speed and input range are auto-configured in reference to input signal.
Auto Sample	Display speed, paper feed speed, memory sampling speed and file recording speed are auto-configured
Auto Range	Range in input amps is auto-configured. (Except for event amp : AP11-105)
Timer Function	Start time, end time and interval can be set.
CSV Conversion	Available (also batch conversion of multiple memories or files) with optional header (environment data) output
Screen Image Saving	Save screen image on HDD at BMP format (colored)
Monitor Output	Images on LCD are output to monitor by XGA (1024 X 768 dots) : RA2800A only
Save/Readout of Settings	Save up to 4 settings (input and main unit settings conditions) on HDD.
Keypad Function	Void key input to prevent operational error (password protected)
Physical Value Conversion	Physical conversion of input signals, full scale change on display, registration of units.
Waveform Display of Event Input	Display position of event amp (AP11-105) and main unit (option for RA2300MKII(-S)) is movable. (every 8ch, Standard position and pitch are configurable. In case of RA2800A with event amps, 8 units are available for display and recording at the same time. (16 units are available for data recording)

■ Optional Unit

AC Bridge Power Supply Unit (RA23-143)

Function	Bridge power source for 2-ch AC strain amp
Power Voltage, Carrier Wave	2Vrms, sine wave 5kHz
Synchronization	Synchronization with other RA2300s using built-in AC bridge power units is available.
Weight	60g or less

RS-232C Unit (RA23-142)

Standard	JIS X5101 (former C6361) complied
Transfer Speed	38400, 19200, 9600, 4800 or 2400bps
Connector	D-sub 9-pin connector
Function	
Shutdown	Shutdown operation when using UPS
Remote Control	Remote Control from PC via RS-232C cable
Weight	50g or less

Remote Unit (RA23-144)

Function	Start, Stop, Mark print, Paper feed is possible by the external signal. Input synchronization pulse, Output error signal. Input UPS protect signal.
Cables	1.5m, I/O connector 28-pin and open wire.
Weight	65g or less

Event Unit (A23-145)*1 Event Unit A (RA23-145A) : RA2300MKII(-S) Only

Function	Input logic signal directly into main unit (independent from other amps)
Number of Signals	16
Input Signals	Voltage input : input voltage range 0 to +5V (Without contacts)
Signal Level	H : over 2.0V, L : below 0.8V
Cables	RA23-145 : Event Input Cable (0311-5252) RA23-145A : Event Input Extension Cable (RA23-127)
Weight	60g or less

Event BOX Set (RA23-146) : RA2300MKII(-S) Only

Function	Input logic signal directly into main unit (independent from other amps)
Number of Signals	16
Input Type	Common ground in unit, case-free
Input Signals	Sets voltage or contact for each channel Voltage input : input voltage range 0 to +24 V Detection level : H level 2.5V or higher, L level 0.5V or higher Contact input : open 2kΩ or higher, close 250Ω or lower
Response Time	Within 1µs (at input 'H', level +5V or higher)
Input Connector	Circular DIN connector 8P X 4, Event Amp Unit side : XT2B-0800 (conformity with DIN45326)

*1 Event unit (RA23-145, RA23-145A)

The difference of unit style is only standard cables (0311-5252 or RA23-127).
Units have same specifications. Regardless of styles, "RA23-145" is printed on units.

Option Unit

Arithmetic FFT Unit (RA23-751) [Equipped standard on the RA2300MKII(-S)]

Object Data	internal memory data, filing data (extension : DRT, FSD) *except for peak style (extension : FPP, IDX)
Interval Statistical Calculation	
Calculation	max, min, P-P value, average, square, actual value, standard deviation, rising time, trailing time
Output File Format	CSV data
Functional Calculation	
Calculation	four arithmetic operations (+, -, x, /), absolute value, first derivation, second derivation, first integration, second integration, square root, index, common logarithm, moving average, trigonometric function (sin, cos, tan, asin, acos, atan)
Output File Format	Binary or CSV data
FFT Analysis	
Function	One signal analysis : linear spectrum, Power spectrum, RMS spectrum, power histogram density, octave analysis (1/1, 1/3) Two signal analysis : transfer function, cross power spectrum, coherence function
Analyzed Data Length	1000 (400), 2000 (800), 4000 (1600)
Window Function	rectangular, hanning, hamming
Output File Format	Binary or CSV data

Unifizer NS3300 (online function, offline function)

OS	Windows7 Professional (32bit) / Home Premium (32bit)
Available System	RA2000 series / RA1000 series / others
Interface	RA2000 series : Ethernet RA1000 series : RS-232C / Ethernet
Connectable Quantity	MAX 8 sets
Remote Control	Pen recorder mode / HD recorder mode / Memory recorder mode / Multi recorder mode (RA2000 series) Memory mode / Real time mode / Transient mode / Filing mode (RA1000 series)
Setting Range of Real Time Transfer Speed	RA series : 1ms to 1000ms (1ms step), 1s to 1000s (1s step)*1 Max recordable time: up to the half size of specified HD in PC ** It may not transfer in set speed depending on CPU speed. Recommended CPU : over 2GHz Recommended memory capacity : over 1GB
Real Time Data Display Function	Y-T waveform, X-Y waveform (split/overwriting), Digital display*2
Play Data Display Function	Y-T waveform, X-Y waveform (split/overwriting), Digital display Data of RA2000 series/ RA1000 series is playable Playable extension: FSD, FPP, DRT, DAT
Cursor Readout of Playing Data	Readout value between cursor 1 and 2, time difference, amplitude difference, max/min value between cursors
Arithmetic Operation	Arithmetic operation between channels, Power method, Square root, Absolute value, Customary logarithm, Index, Actual value, Trigonometric function, Moving average, Derivation, Integration, Below functions are combined together Sine, Cosine, Tangent, Arcsine, Arccosine, Arctangent, Absolute value, Index, Logarithm natural, Customary logarithm, Square root, Cube root, Arithmetic operation CH specification, Power method, First-order derivation, Second-order derivation, First-order integration, Second-order integration, Saved data reference 1, Saved data reference 2, Moving average
File Conversion	Conversion into CSV file following condition can be set • Specification of conversion area point, of period (μs, ms, sec), of time • Conversion channel • Break character comma(,), TAB • Thinning out, simple, max/min value, average value, peak value • Adding of header information • Saved file name
Saving and Reading of Recorded File Condition	Available for arbitrary files

*1 : Setting speed may not work due to constraint of main unit or CPU speed in PC.
*2 : Real time monitor is not displayed for RA1000 series.

Sensitive DIV unit (RA28-112) : RA2800A only

Amplifier	2CH High resolution DC amplifier : AP11-101 2CH FFT amplifier : AP11-102 (V measuring mode) 2CH High speed DC amplifier : AP11-103 Vibration 2CH RMS amplifier : AP11-109 (V measuring mode) 2CH Zero suppression amplifier : AP11-111
Sensitivity Display	AC200V/cm, AC100V/cm, AC63.5/cm, 100V/cm, 50V/cm, 25V/cm, 10V/cm, 5V/cm, 2.5V/cm, 1V/cm, 0.5V/cm : Max input voltage ±500V 0.1V/cm, 0.05V/cm: Max input voltage ±100V
Amplitude Adjustment	All range : fine adjustment of recording amplitude AC range : fine adjustment in AC range
Waveform Recording	Waveform division 1/1 fixed (1 scale is 1cm on recording papers)
Grid	10mm standard, 10mm, 10mm longitudinal, OFF switch, (NO 5mm grid) 1cm X 1cm grid printing by default
Scale Print	Print of sensitivity information (no scale value)
Trigger Mark	Print of trigger time, ON/OFF function (arrows are always printed)
Speed Display	s/div range display (Pen recorder, Memory recorder, HD recorder)

Synchronous unit (RA28-132) : RA2800A only

Max Synchronous Units	Total 10 sets
Connector / Cable Length	Synchronous connector : RJ45 compliance Connection cable: Litz wire STP (Shield Twist Pair), Straight connection wire (CAT5e or CAT6 compliance) Cable length : max 200m
Setting	Selection of synchronous mode Master/ Slave / External synchronization
Delay Time (including connected units to whole connection cable length and trigger detection delay time)	
8μs	Within 200m : 2 units / 100m : 3 units / 33m : 4 units
10μs	Within 200m : 3 units / 100m : 5 units / 33m : 7 units
20μs	Within 200m : 5 units / 100m : 7 units / 33m : 10 units
50μs	Within 200m : 10 units

Utility software RA Viewer (RA23-701) This software is available for download after completion of user registration.

OS and Display	Windows2000 / XP / Windows7 Professional (32bit) / Home Premium (32bit), display 1024 X 768 and above
Available System	RA2000 series / RA1000 series
Y-T Display	
Peace Wise Representation	1 to 16 split
Display Magnification	X 100 to X 10,000
Thumbnail Function	Optional 1ch of whole data is available for display on thumbnail bar
Value Display	Value, cursor value, value + cursor value (switching)
Search Function	Search by cursor, time, address, max/min, event
X-Y Display	
Display Channel Number	Selected data can be displayed on x-axis:1ch, y-axis:3ch
Output File Format	Binary or CSV data

Input Unit Specifications

2-CH High Resolution DC Amp (AP11-101) & 2-CH High Speed DC Amp (AP11-103)

Input	2 chs/unit, isolated unbalanced input, isolated BNC connector
Input Coupling	AC and DC coupling
Input Impedance	1MΩ or higher
Measurement Range	0.1, 0.2, 0.5, 1, 2, 5, 10, 20, 50, 100, 200, 500V
Range Accuracy	AP11-101 : within ±0.3% FS (within ±0.8% FS at ±500V) AP11-103 : within ±0.5% FS (within ±1% FS at ±500V)
Offset Accuracy	AP11-101 : within ±0.3% FS (at 23°C) AP11-103 : within ±0.5% FS
Linearity	AP11-101 : within ±0.1% FS AP11-103 : within ±0.2% FS
Allowable Input Voltage	Range of 10V to 500V : ±500V max (DC or AC peak values) Range of 0.1V to 5V : ±100V max (DC or AC peak values)
CMV	Unit only : 42V (DC or AC peak values) When using isolated BNC cable (optional) : 300VAC
Frequency Response	AP11-101 / at DC coupling : DC to 50kHz (+0.5, -3dB) at AC coupling : 0.3 to 50kHz (+0.5, -3dB) AP11-103 / at DC coupling : DC to 400kHz (+0.5, -3dB) at AC coupling : 0.3 to 400kHz (+0.5, -3dB)
Low-pass Filter	AP11-101 / Bessel type (attenuation factor: -12dB/OCT) 30, 300, 3kHz, OFF (+0.5, -3dB) AP11-103 / Bessel type (attenuation factor: -12dB/OCT) 5, 50, 500, 5k, 50kHz, OFF (+0.5, -3dB)
A/D Converter	AP11-101 : 16-bit, 100kHz max (simultaneous 2-ch sampling) AP11-103 : 12-bit, 1MHz max (simultaneous 2-ch sampling)
Temperature Stability	AP11-101 / zero point : within ±0.02% FS/°C AP11-103 / zero point : within ±0.03% FS/°C
Gain (Range)	within ±0.01% FS/°C
Weight	AP11-101 : approx 230g or less, AP11-103 : approx 240g or less

F/V Converter (AP11-108)

Input	1 ch/unit, isolated unbalanced input, Insulated BNC connector
Input Coupling	AC and DC coupling
Input Impedance	100kΩ or higher
Input Frequency Range	1Hz to 10kHz (pulse width: 20μs or longer)
Measurement Range	100, 200, 500, 1k, 2k, 5k, 10kHz-FS
Accuracy	Within ±0.5% FS
Linearity	Within ±0.3% FS
Trigger Level	Selectable from 0V or 2.5V
Allowable Input Voltage	±100V (DC or AC peak values)
CMV	Unit only: ±42V (DC or AC peak values) When using isolated BNC cable (optional) : 300VAC
Response Time	Approx 20ms (at the range of 10kHz)
A/D Converter	16-bit, 100kHz max
Temperature Stability	Zero point : within ±0.03% FS/°C Gain (range) : within ±0.02% FS/°C
Weight	125g or less

2-CH Vibration/RMS Amp (AP11-109)

Input	2 chs/unit, isolated unbalanced input, isolated BNC connector
Input Coupling	AC and DC coupling
Input Impedance	1MΩ or higher
Power Supply for Sensor	2mA, 18V or higher
Measurement Range	0.1, 0.2, 0.5, 1, 2, 5, 10, 20, 50, 100, 200, 500V
Accuracy	Voltage Within ±0.3% FS (within ±0.8% FS at ±500V) RMS Within ±2% FS (at DC and 40Hz to 20kHz)
Linearity	within ±0.1% FS
Crest Factor	2.8 max (when used as RMS amp)
CMV	Unit only : ±42V (DC or AC peak values) When using isolated BNC cable (optional) : 300VAC
Frequency Response	DC coupling : DC to 50kHz (+1, -3dB) AC coupling : 1 to 50kHz (+1, -3dB)
Low-pass Filter	Butterworth type (attenuation factor: -24dB/OCT) 30, 100, 300Hz, 1kHz and OFF
High-pass Filter	Butterworth type (attenuation factor: -24dB/OCT) 10, 30, 100Hz and OFF
A/D Converter	16-bit, 100kHz max
Temperature Stability	Zero point : within ±0.02% FS/°C Gain (range) : within ±0.01% FS/°C
Weight	270g or less

2-CH FFT Amp (AP11-102)

Input	2 chs/unit, isolated unbalanced input, isolated BNC connector
Input Coupling	AC and DC coupling (only AC coupling when connected with amp-embedded piezoelectric accelerometer)
Input Impedance	1MΩ or higher
Power Supply for Sensor	2mA, +18V or higher
Measurement Range	0.1, 0.2, 0.5, 1, 2, 5, 10, 20, 50, 100, 200, 500V
Range Accuracy	Within ±0.3% FS (within ±0.8% FS at ±500V)
Linearity	Within ±0.1% FS
Allowable Input Voltage	500V (DC or AC peak values) (±30V at AC coupling in ±0.1 to 5V range)
CMV	Unit only: ±42V (DC or AC peak values) When using isolated BNC cable (optional) : 300VAC
Frequency Response	DC coupling : DC to 50kHz (+0.5, -3dB) AC coupling : 0.3 to 50kHz (+0.5, -3dB/OCT)
Low-pass Filter	Bessel type (attenuation factor: -12dB/OCT) 30, 300, 3kHz, OFF (+0.5, -3dB)
Anti-aliasing Filter	20, 40, 80, 200, 400, 800, 2k, 4k, 8k, 20k, 40kHz Drop characteristics : -72dB/OCT at 1.5 X fc
Offset Accuracy	within ±0.3% FS (at 25°C)
A/D Converter	16-bit, 100kHz max
Temperature Stability	Zero point : within ±0.02% FS/°C Gain (range) : within ±0.01% FS/°C
Weight	240g or less

2-CH TC/DC Amp (AP11-106A)

Input	2 chs/unit, isolated unbalanced input, terminal block M4
Input Coupling	DC coupling
Input Impedance	10MΩ or higher (approx 1MΩ at 5, 10, 20, 50VFS in DC range)
Thermocouple	R, T, J, K, W
Measurement Range (Temperature)	R : 1760°C FS (0 to 1760°C)
	T : 400°C FS (-200 to 400°C)
	J : 1100°C FS (-200 to 1100°C)
	K : 500°C FS (-200 to 500°C), 1370°C FS (-200 to 1370°C)
	W : 2300°C FS (0 to 2300°C)
Measurement Range (Voltage)	100, 200, 500mV, 1, 2, 5, 10, 20, 50V FS
Range Accuracy	Temperature ±0.5% FS (within ±1% at 0°C or lower)
	Voltage ±0.3% FS
Cold Junction Compensation	Internal/external switchable. Accuracy: within ±2°C (within ±1°C at stable temperature of 20°C at input terminal)
Linearity	Within ±0.1% FS
Allowable Input Voltage	±50V (DC or AC peak values)
CMV	±42V (DC or AC peak values)
Frequency Response	DC to 40kHz (+0.5, -3dB)
Low-pass Filter	Bessel type (attenuation factor : -18dB/OCT) 1, 30, 500, 5kHz, OFF (+0.5, -3dB)
A/D Converter	15 bits, 100kHz max (simultaneous 2-ch sampling)
Temperature Stability	When used as temp amp gain (range): within ±0.04% FS/°C
	When used as DC amp zero point: within ±0.03% FS/°C gain (range): within ±0.01% FS/°C
Weight	240g or less

Event Amp (AP11-105)

Input	8 channels/unit
Input Type	Common ground in unit, case-free
Input Signals	Sets voltage or contact for each channel
	Voltage input : input voltage range 0 to +24V
	Detection level : H level 2.5V or higher L level 0.5V or lower
	Contact input: open 2kΩ or higher, close 250Ω or lower
Response Time	Within 1μs (at input "H", level +5V or higher)
Input Connector	2 circular 8 pin DIN connectors, event amplifier unit side: XT2B-0800 (DIN45326 compliant)
Cables	Logic cable (0311-5007) X 2, alligator clip cord (0311-5009) X 2 IC clip cord (0311-5008) X 2
Weight	100g or less

*When installed to the RA2800A, up to 8 units can record and display simultaneously. Up to 16 units can be used for just recording.

Charge Converter (AP11-901, AP11-902, AP11-903)

Gain	1.0mV/pC±5% (AP11-901, AP11-902)
	0.1mV/pC±5% (AP11-903)
Max Input Charge	5000pC (AP11-901, AP11-902)
	50000pC (AP11-903)
Frequency Range	Approx 1.6Hz to 50Hz
Max Output Voltage	5Vp-p or lower
Drive Voltage	12 to 25 VDC
Drive Current	0.5 to 5mA
Rated Noise	20μVrms or lower (AP11-902), 100μVrms or lower (AP11-901, AP11-903)
Phase	180°
Operating Temperature	-20 to 80°C (AP11-901), -20 to 110°C (AP11-902, AP11-903)
Connector	Input : miniature connector (10-32UNF)
	Output : male BNC terminal (AP11-901) female BNC connector (AP11-902, AP11-903)
Weight	20g or less (AP11-901), 65g or less (AP11-902, AP11-903)

2-CH AC Strain Amp (AP11-104A) & 2-CH DC Strain Amp (AP11-110)

Input	2 chs/unit, isolated unbalanced input, isolated NDIS connector	
Input Coupling	AP11-104A: balanced input (isolation : between channels inside unit or between each channel and chassis) AP11-110 : DC	
Input Impedance	10MΩ+ 10MΩ or higher (AP11-110 only)	
Bridge Power Supply	AP11-104A : sine wave 2Vrms, 5kHz (AC bridge power supply RA23-143 required) AP11-110 : 2V, 5V	
Applicable Gauge Resistance	AP11-104A : 120 to 1kΩ AP11-110 : 120 to 2kΩ (at BV=2V), 350 to 2kΩ (at BV=5V)	
Gauge Factor	1.5 to 2.5	
Range of Balance	AP11-104A / resistance: ±2% (10000μe) or lower capacitance: 2000pF or lower	
	AP11-110 / ±3% (15000x10-6μe) or lower	
Balance Method	AP11-104A	AP11-110
	Resistance	Auto-balance
	Capacitance	Auto-balance (500pF or lower eliminated)
	Balance Time	Within 1s at 1 channel
Remained Voltage Accuracy	Within ±0.5% FS	Within 0.3% FS
Max Sensitivity (AP11-104A)	Over full scale at 500μe (at bridge voltage of 2V or higher)	
Measurement Range	AP11-104A	AP11-110
	Strain	1k, 2k, 5k, 10k, 20kμe·FS 2k, 5k, 10k, 20k, 50kμe·FS (at BV=2V) 800, 2k, 4k, 8k, 20kμe·FS (at BV=5V)
Voltage	N/A	2, 5, 10, 20, 50mV FS
Accuracy	Within 0.3% FS (AP11-110 only)	
Internal Calibrator and Accuracy	±0.5k, 1k, 2k, 3k, 5kμe Accuracy : within ±0.5% FS (AP11-104A only)	
Linearity	AP11-104A: within ±0.2% FS,	
	AP11-110: within ±0.1% FS	
CMV	300VAC	
Allowable Input Voltage	±8V (DC or AC peak value) (AP11-110 only)	
Frequency Response	AP11-104A : DC to 2kHz (+1, -3dB)	
	AP11-110 : DC to 50kHz (+0.5, -3dB)	
Low-pass Filter	AP11-104A : butterworth type (attenuation factor : -12dB/OCT) 10, 30, 100, 300Hz and OFF (+1, -3dB) AP11-110 : Bessel type (attenuation factor : -12dB/OCT) 10, 30, 100, 300Hz and OFF (+1, -3dB)	
A/D Converter	16 bits, 100kHz max	
Temperature Stability	Zero point : within ±0.05% FS/°C (AP11-104A), within ±0.1% FS/°C (AP11-110)	
	Gain (range) : within ±0.05% FS/°C (AP11-104A), within ±0.01% FS/°C (AP11-110)	
Weight	285g or less (AP11-104A), 240g or less (AP11-110)	

2-CH Zero Suppression Amp (AP11-111)

Input	2 chs/unit, isolated unbalanced input, isolated BNC connector
Input Coupling	AC and DC coupling (max allowable input ±30V at AC coupling for measurement range ±0.1 to 2V)
Input Impedance	1MΩ or higher
Measurement Range	±0.1, 0.2, 0.5, 1, 2, 5, 10, 20, 50, 100, 200, 500V FS
Range Accuracy	Within ±0.5% FS (within ±0.8% FS at ±500V FS)
Offset Accuracy	within ±0.5% FS
Linearity	within ±0.2% FS
Allowable Input Voltage	range of ±5V to ±500V: ±500V max (DC or AC peak value) range of ±0.1V to ±2V: ±100V max (DC or AC peak value)
CMV	±42V (DC or AC peak values) When using isolated BNC cable (optional) : 300VAC
Frequency Response	At DC coupling : DC to 5kHz (+0.5, -3dB) At AC coupling : 0.3 to 5kHz (+0.5, -3dB)
Low-pass Filter	Bessel type (attenuation factor : -12dB/OCT) 30, 300, 3kHz, OFF (+0.5, -3dB)
Suppression Voltage	±13V at ±0.1, 0.2, 0.5, 1 and 2V range
	±110V at ±5, 10, 20, 50, 100, 200, 500V range
	Resolution : 500μV or less at ±0.1, 0.2, 0.5, 1 and 2V range 5mV or less at ±5, 10, 20, 50, 100, 200, 500V range
	Accuracy : within ±0.5% (at suppression voltage +13V max) Temp Stability : ±0.005%/°C (at suppression voltage +13V max)
Auto Zero Suppression	Recognize current input voltage and suppress the voltage automatically.
	Time : within 1 sec Remain voltage : within ± (resolution of suppression voltage x 10) V
A/D Converter	16-bit, 100kHz max (simultaneous sampling of 2chs)
Temperature Stability	Zero point : within ±0.03% FS/°C Gain (range) : within ±0.01% FS/°C
Weight	260g or less

Main Unit & Accessories

	Item	Model	Rating
Main Unit *1	Omniace	RA2300MKII	HDD (160 GB) specification : Max 8 amplifier units
		RA2300MKII-S	SSD (256GB) specification : Max 8 amplifier units
		RA2800A	HDD (40GB) specification : Max 16 amplifier units
	Standard accessories	RA2300MKII(-S) : AC power cable X 1, recording paper X 1, paper holder X 1, input unit slot cover plate X 1 set, display protection board X 1 RA2800A : AC power cable X 1, recording paper X 1, paper holder X 1, input unit slot cover plate X 1 set, user's manual X 1	

*1 Input units are not included.

	Item	Model	Rating
Input Unit	2-ch High Resolution DC Amp	AP11-101	Input : ±100mV to ±500V, A/D resolution : 16-bit, sampling : 10μs
	2-ch High Speed DC Amp	AP11-103	Input : ±100mV to ±500V, A/D resolution : 12-bit, sampling : 1μs (RA2800A : 2μs)
	2-ch Zero Suppression Amp	AP11-111	Input : ±100mV to ±500V, A/D resolution : 16-bit, sampling : 10μs
	2-ch FFT Amp	AP11-102	Anti-aliasing filter: 72dB/OCT, with power supply for sensor
	Event Amp	AP11-105	Input : 8 logics (voltage/contact)
	2-ch TC/DC Amp	AP11-106A	Input : R, T, J, K, W (±100mV to ±50V), A/D resolution : 15-bit
	2-ch AC Strain Amp ²	AP11-104A	Frequency response : 2kHz, bridge power supply : 5kHz
	2-ch DC Strain Amp	AP11-110	Input : 800μe to 20k μe (BV=5V), 2kμe to 50k μe (BV=2V)
	2-ch Vibration/RMS Amp	AP11-109	Input : ±100mV to ±500V, sampling : 10μs, with power supply for sensor
	F/V converter	AP11-108	Input : 1 Hz to 10k Hz
	TC/DC Amp	AP11-107	Input : R, T, J, K (±10mV to ±50V), A/D resolution : 14-bit

² Optional AC bridge power unit (RA23-143) required.

Optional Unit	Item		Model	Rating
	Arithmetic FFT Unit		RA23-751	RA2800A only
	Sensitivity DIV setting Unit		RA28-112	RA2800A only
	Synchronous Unit		RA28-132	RA2800A only
	Interface	Remote Unit	RA23-144	W/cable (1.5m, I/O connector 28-pin and open wire)
		RS-232C Unit	RA23-142	
	AC Bridge Power Supply Unit		RA23-143	2 Vrms sine wave 5kHz required when using the AP11-104A
	Dust Cover		RA11-121	RA2300MKII(-S) only
			RA28-114	RA2800A only
	Touch Panel Protective Sheet		RA23-178	RA2300MKII(-S) only, 1 sheet
	Display cover		RA23-179	RA2300MKII(-S) only
	Event Input	Event Unit	RA23-145	RA2300MKII(-S) only, W/Cable (0311-5252)
		Event Unit A	RA23-145A	RA2300MKII(-S) only, With event unit relay cable (RA23-127)
		Event Box Set	RA23-146	RA2300MKII(-S) only (Consists with RA23-328, 0311-5257 as a set.)
	Hard Carrying Case (w/Casters)		RA23-177	RA2300MKII(-S) only
			RA28-113	RA2800A only
	Soft Carrying Case		RT36-115	RA2300MKII(-S) only
	Z-fold Paper Storage Box		RA12-103	RA2300MKII(-S) only, including Z-fold paper adaptor (RA12-301)
			RA28-115	RA2800A only, including Z-fold paper adaptor (7191-5010)
	Z-fold Paper Adaptor		RA12-301	RA2300MKII(-S) only
			7191-5010	RA2800A only
	Rack Mount Bracket for JIS		RA28-117	RA2800A only
	Rack Mount Bracket for EIJ		RA28-118	RA2800A only
	Charge Converter*1		AP11-901	
			AP11-902	
			AP11-903	
	AC/DC Voltage Detector		1539	Voltage (4 input) variation converted to logic signal (H, L) and output
	AC Voltage Level Detector		1540	AC100V, AC120V voltage variation (±10%, ±20%) output as pulse
			1543	AC220V, AC240V voltage variation (±10%, ±20%) output as pulse
	Signal Input Cable		0311-5184*2	Length: 2m, small plug for microphone and insulated BNC, 2009R clamp meter
	AC/DC Digital Clamp Meter		2009R*2	For high current (2000A, 400A / DC, 40 to 1 kHz), φ55, 0311-5184 required
	Clamp Adaptor		8112*3	For low current (20A, 2A, 0.2A / 40 to 10 kHz), 0243-3021 required
	AC/DC Clamp Sensor		8115*3	For low current (AC / 130A, DC / 180A / DC, 40 to 1kHz), φ12, 0243-3021 required
	UPS Cable		0311-5256*4	Length : 2.5m

*1 Required for using piezoelectric accelerometer with 2-ch vibration/RMS amp or 2-ch FFT amp.
*2 Use signal input cable (0311-5184) if connecting output from 2009R to RA2300MKII(-S)/RA2800A
*3 Use a BNC adaptor (0243-3021) if connecting output from 8112 and 8115 to RA2300MKII(-S)/RA2800A
*4 Required for RS-232C Unit (RA23-142), UPS cable (0311-5256) to use auto shutdown function.

Optional Unit	Item		Model	Rating
	Signal Input Cable		0311-5175	Length : 2m, isolated BNC connector and alligator clip (+: red, -: black)
			0311-5200	Length : 2m, isolated BNC connector and metal BNC connector
			0311-5160*5	Length : 2m, 2-banana and alligator clip (+: red, -: black)
			0311-5174*6	Length : 2m, 2-banana and metal BNC connector
	AC bridge Power Distribution Cable		0311-2057	Length : 2m, metal BNC connector and alligator clip (+: red, -: black), mold color: black
			47226	Length : 2m, metal BNC connector and metal BNC connector
	Logic IC Cable		0311-5007	Logic IC cord (1 pc), 2 pairs included standard with event amplifier (AP11-105)
			0311-5008	IC clip cord (4 pcs/set), 2 pairs included standard with event amplifier (AP11-105)
			0311-5009	Alligator clip cord (4 pcs/set), 2 pairs included standard with event amplifier (AP11-105)
	Event Input Cable		0311-5001	Length : 1.5m, DIN8P and open wire
	Event Input Extension Cable		0311-5005	Length : 1.5m, DIN8P plug and DIN8P socket
BNC Adaptor		0243-3021	Isolated BNC connector and S terminal plug	
BNC Adaptor (for AC bridge power distribution)		0243-2118	Jack, plug, jack T-branch for AC bridge power distribution, 47226 required for sync	
AC Power Cable		0311-5044	Length : 2.5m	

*5 BNC adaptor (0243-3021) required if connecting to input unit with isolated BNC terminal.
*6 The common mode input voltage of metal BNC is 30 Vrms, 60 VDC or less.

Recording Paper *7	Item		Model	Rating
	Recording Paper		YPS106	220 X 30m roll paper (5 rolls/box)
	Recording Paper (w/perforated line)		YPS108	220 X 30m roll paper (5 rolls/box)
	Recording Paper (100m roll paper)		YPS114	220 X 100m roll paper (1 roll/box) RA2800A only
	Recording Paper (Z-fold paper)		YPS112	220 X 201m Z-fold paper (1 set/box) RA12-103 required

*7 Quality not assured if used papers other than above.

Software	Item		Model	Rating
	Unifizer		NS3300	Windows7 Professional (32 bit) / Home Premium (32 bit)

External Drawing

■ Dimensions of RA2300MKII(-S)

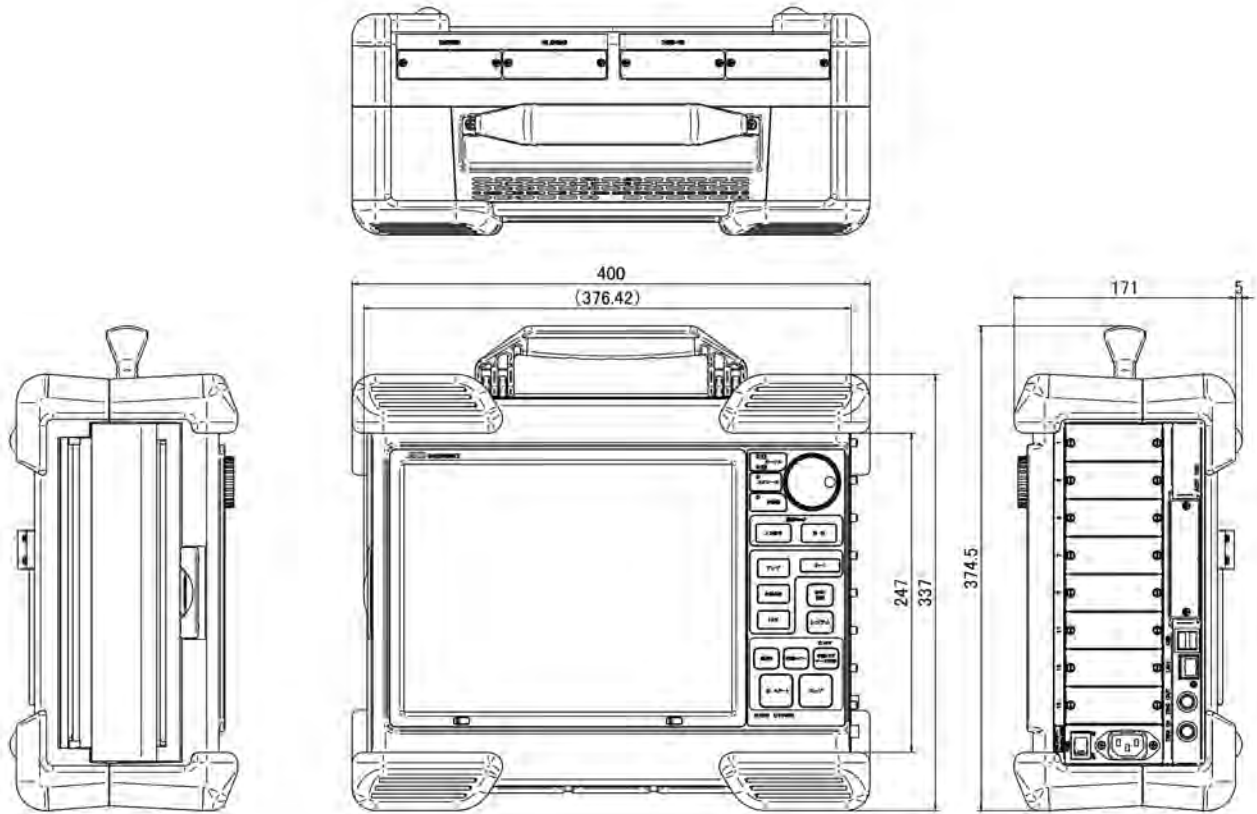

■ Dimensions of RA2800A

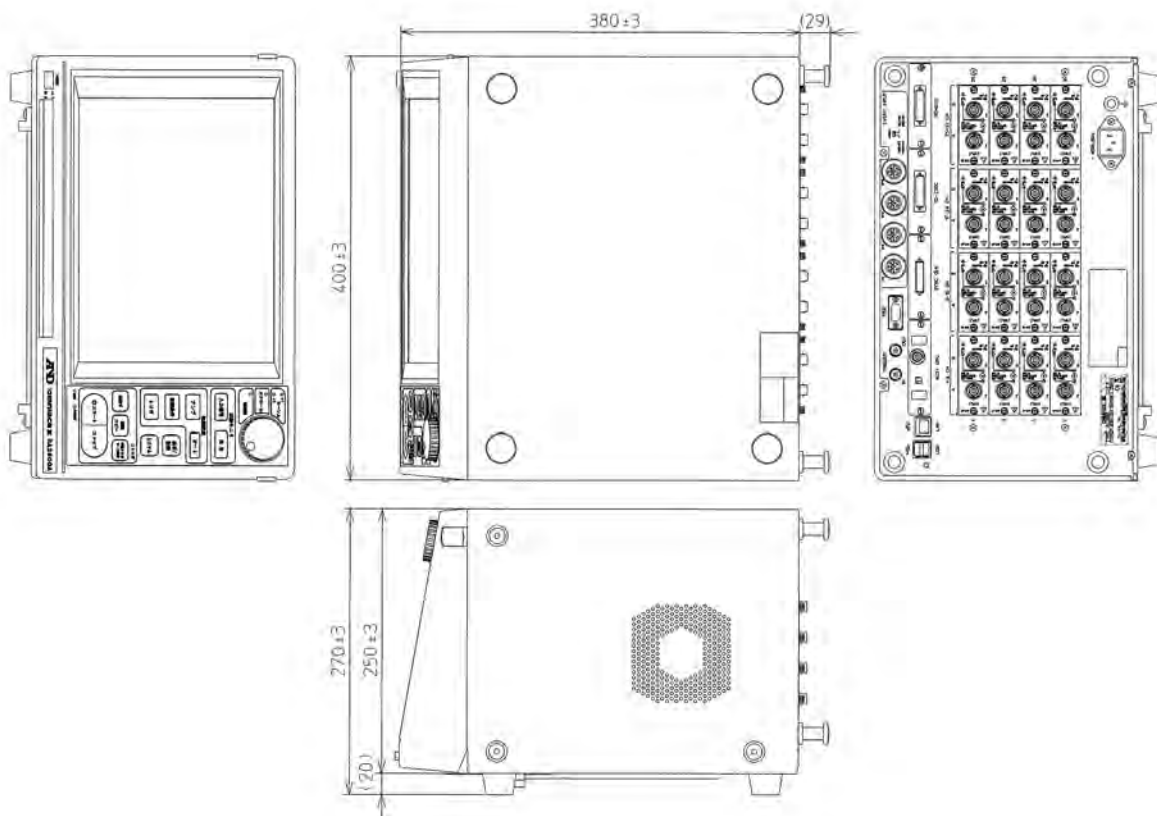

Option Unit Appearance

RA2300MKII(-S) / RA2800A



RA2300MKII(-S) / RA2800A



RA2800A Only



RA2300MKII(-S) Only



RA2300MKII(-S) Only



RA2800A Only

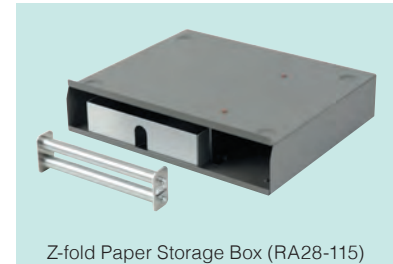

RA2300MKII(-S) Only



RA2300MKII(-S) Only



RA2800A Only



RA2300MKII(-S) Only



nbn
ELEKTRONIK AG
www.nbn-elektronik.ch

nbn Elektronik AG
Haslenstrasse 7
CH-8903 Birmensdorf
Tel. +41 (0)44 523 63 33
Fax +41 (0)44 493 50 32
sales@nbn-elektronik.ch

 **Attention to Safety!**

● For proper use, read the instruction manuals carefully before use

A&D ...Clearly a Better Value

A&D Company, Limited
3-23-14 Higashi-Ikebukuro, Toshima-ku, Tokyo 170-0013 JAPAN
Telephone:[81](3) 5391-6132 Fax:[81](3) 5391-6148
http://www.aandd.jp

● Appearance and/or specifications subject to change for improvement without notice.
● Contents of this catalog last updated November 2017

*RA-ADCC-02-ZW2-17b02GP