

# ScopeCorder

DL750/DL750P/SL1400



Instantaneous display **1GW**  
**GiGAZoom**  
ENGINE™

Maximum sample rate **10MS/s**  
Isolated **x16ch**

High resolution **A4**  
**thermal printer**

For more information, go to  
[tmi.yokogawa.com](http://tmi.yokogawa.com)  
Test & Measurement Instruments



**3**-Year Warranty 

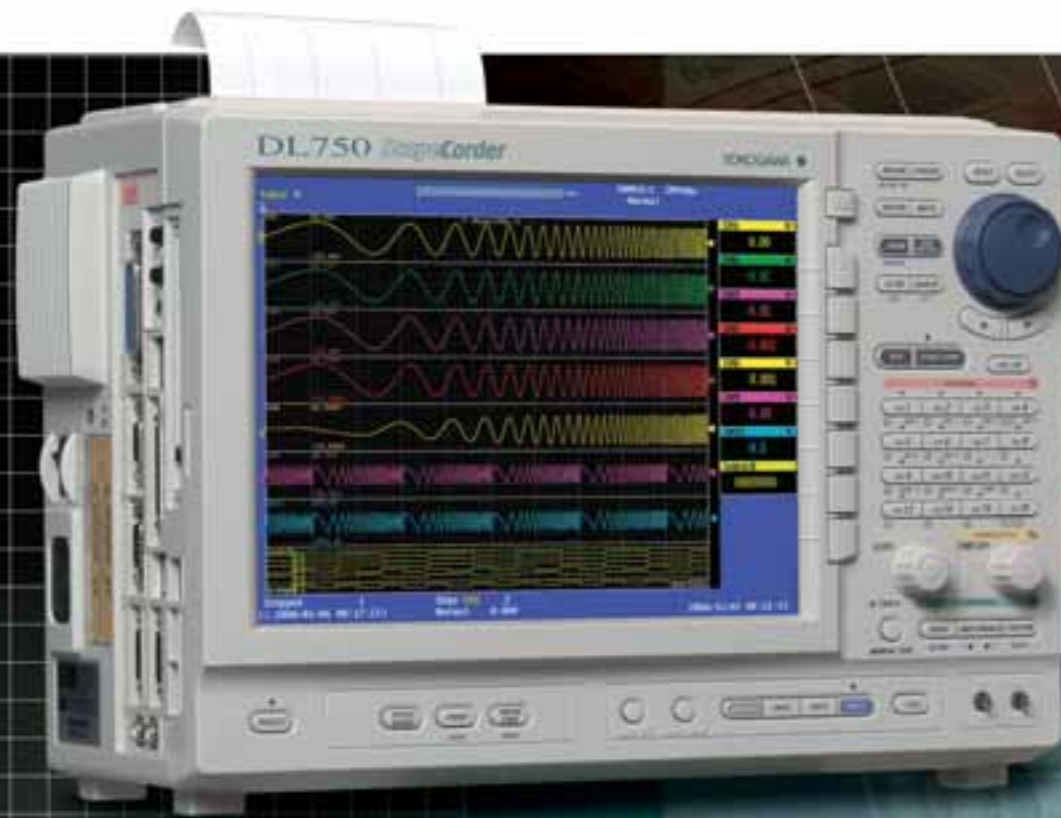

# DL750

ScopeCorder



**GiGAZoom**  
ENGINE™

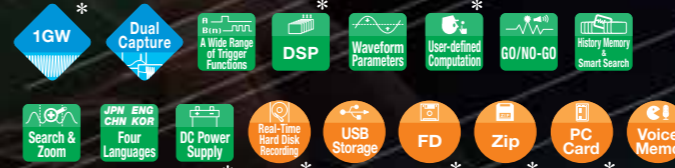

# ScopeCorder

*A ScopeCorder is a flexible and powerful multi-channel test and measuring solution which combines the benefits of a high precision oscilloscope and a traditional paper chart recorder.*

## Modules

Select from 11 different plug-in modules

- High-speed voltage
- High-voltage
- High-precision voltage
- Frequency
- Temperature
- Strain
- Acceleration



*An easy-to-use plug-in module type chart recorder*

# SL1400



*Scope & Chart Recorder Two-in-One*

# DL750P

\*:optional

## GIGAZoom Function for Instantaneous Full-Length Display of 1 GW of Data

1 GW memory for full-length display and instantaneous zooming (to user-specified size)

A large-scale, high speed ASIC was created to give the ScopeCorder the ability to show the entire 1 GW of data on the display in real time

Two zoom windows are available for displaying data. Zooming can be done in real-time or after data recording has stopped.

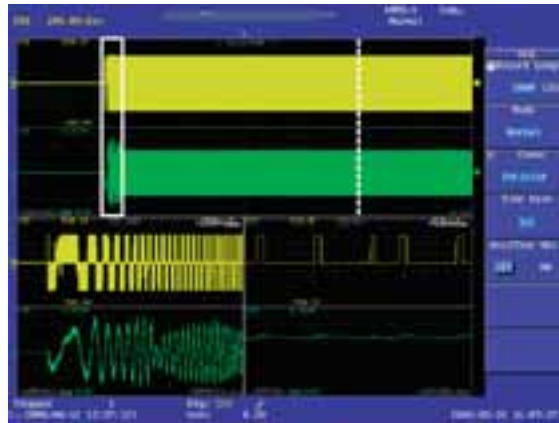

The high-speed data compression engine  
**GiGAZoom**  
ENGINE™

Measuring inverter output signals using the 10 MS/s high-speed 12-bit isolated module 701250, isolated probe 700929 and current probe 701933.

Multi-Channel 2-Location Zoom Function

## Capturing Signals Using the Long Memory Capacity

### For Accurately Capturing Complex Signals or Long Waveforms

The ScopeCorder's standard memory capacity is 50 MW (2.5 MW per channel). This can be expanded (DL750/DL750P optional) to as much as 1 GW (50 MW per channel).

#### ■ Benefits of GigaWord Recording

You can record data for 10 days (1 day/div) on the main screen, while displaying 1-second recordings (100 ms/div) in real time on the zoom screen.

The large memory capacity lets you capture all of your data while still maintaining a sample rate fast enough to see any abnormal phenomena.

#### ■ Efficient Memory Use

Sufficient memory length is available even when 16 channels are used, so you can conduct extended observations on multiple channels (2.5 MW per channel with standard memory, 50 MW per channel with maximum memory (DL750/DL750P optional)).

04

### 1GW Long-Term Measurements with Large Capacity Memory (1 GW Total)

DL750 DL750P

Sample Rate	Using 1 ch	Using 16 ch
10 MS/s	100 sec	5 sec
1 MS/s	10 min.	50 sec
100 kS/s	2 hours 30 min.	5 min.
10 kS/s	20 hours	1 hour 20 min.
1 kS/s	10 days	10 hours
200 S/s	30 days	2 days 12 hours
100 S/s	30 days	5 days
10 S/s	30 days	30 days

### 50MW Long-Term Measurements with Large Capacity Memory (50 MW Total)

SL1400

Sample Rate	Using 1 ch	Using 16 ch
10 MS/s	5 sec	0.2 sec
1 MS/s	50 sec	2 sec
100 kS/s	5 min.	20 sec
10 kS/s	1 hour	3 min. 20 sec.
1 kS/s	10 hours	30 min.
200 S/s	2 days 2 hours	2 hours
100 S/s	5 days	5 hours
10 S/s	30 days	2 days 2 hours

### Data Storage to External Memory Media

#### Storage

Various data can easily be stored into your USB flash memory device and PC card (Flash ATA card, Compact Flash, Microdrive) to transfer the data to your PC.



### Real-Time Hard Disk Recording (with the /C8 Option)

#### Recorder-Like Real-Time Data Recording over Extended Periods

With the optional internal hard disk, you can record measurements to the hard disk in real time. This makes it easier to manage and analyze data using PCs and other tools.

- Maximum data capacity: 1 GW
- Maximum sample rate: 100 kS/s (using 2 ch)





# DualCapture: A Powerful Tool for Durability Test Data Analysis

## Simultaneous High-Speed and Low-Speed Recording Using DualCapture

During durability testing, it is necessary to monitor the longterm trends of your data as well as capture the high speed transients that might occur. This presents a challenge as trend data is usually recorded at a slower sampling speed that might miss the transient phenomena. To meet this challenge, the DL750/DL750P offers the DualCapture function.

Using DualCapture, you can now record your trend data with a slow sampling speed and still be able to capture the transient phenomena with a faster sampling speed.

### Integration of a High-Speed Sampler (Oscilloscope) and Low-Speed Sampler (Recorder) in a Single Unit

High-speed sampler: Trigger on abnormal high-speed phenomena  
 Low-speed sampler: Roll recording (trend recording)

### Separate Memory Management for Each Sampler

Maximum memory for low-speed sampler : 100 MW  
 Maximum memory for high-speed sampler : 10 kW x 500 screens

### High-Speed Sampling Triggered Only by Abnormal Phenomena Occurring During Long-Term Observation (Low-Speed Sampling)

Effective for separately capturing data at high speed during measurements.

#### Main waveform: Roll mode display

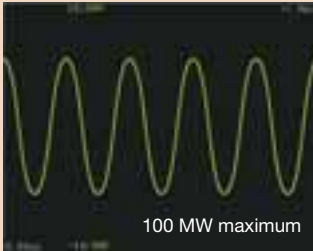

Max. recording length  
 5 MW (standard model)  
 10 MW (/M1 model)  
 50 MW (/M2 model)  
 100 MW (/M3 model)

Sub waveform acquired here

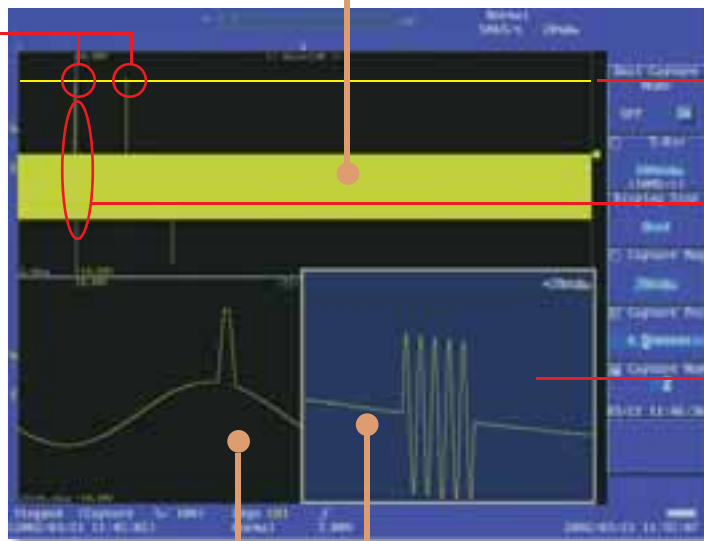

#### Event waveforms

Displays the time when the sub waveform was acquired as an event waveform

#### Main waveform

Observe this phenomenon using the zoom function (horizontal zoom) and DualCapture function

#### Sub (high-speed) waveform display frame

When displayed using the zoom function  
 Cannot tell how many burst waveforms occurred

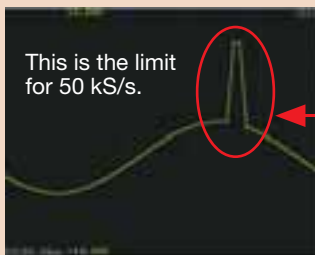

This is the limit for 50 kS/s.

The waveform shown above was captured at a sampling rate of 50 kS/s. The occurrence of noise can be confirmed in the graph, but the time resolution is too low to capture the waveform accurately.

Same phenomenon

#### When displayed using the DualCapture function

Able to observe the occurrence of five burst waveforms

#### Sub waveform: Trigger display

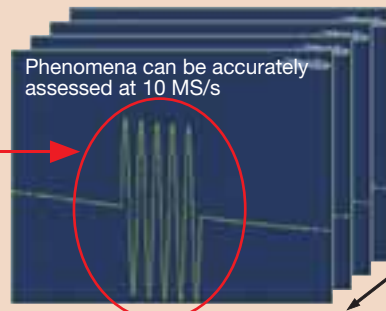

Max. recording length  
 Fixed to 10 kW

100 screens maximum (standard model)  
 250 screens maximum (/M1 model)  
 500 screens maximum (/M2 and /M3 models)

With DualCapture, the user sets triggers for capturing sudden phenomena. Up to 500 phenomena can be collected in a memory length of 10 kW at a maximum sampling rate of 10 MS/s.



## DSP Channel Real-Time Math Function (with the /G3 Option)

Six digital signal processing (DSP) channels have been added. The DSP channels enable you to perform math and digital filtering in real time while acquiring waveforms. Each DSP channel can perform up to four arithmetic operations and filtering at high speed, without slowing down waveform acquisitions.

### Features:

- Real-time display of calculated waveforms in roll mode
- Triggers on calculated waveforms
- Calculated parameters such as cutoff of digital filtering and frequency can be changed in real time
- Simultaneously display up to 22 channels (16 analog CH + 6 DSP CH)
- Provides the same memory length as with analog channels
- Arithmetic calculations between channels (addition, subtraction, multiplication, division), digital filtering (LPF, BPF, HPF), differentiation, and integration

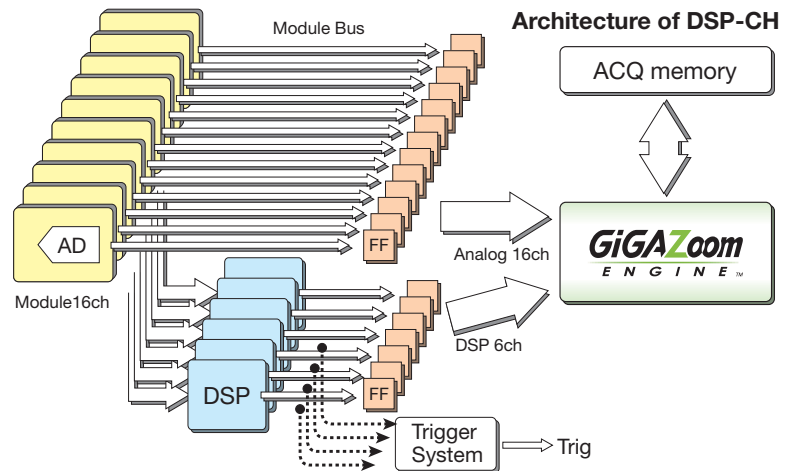

## Automatically Measure Waveform Parameters

### Easily Find and Display Waveform Frequency, Rise Time, and Other Parameters

Waveform parameters such as voltage, frequency, and RMS are measured automatically. In addition to general parameter measurement function, the ScopeCorder comes standard with functions such as the following:

#### Cycle Statistical Calculation

This function calculates statistical information about the waveform. Maximum value, minimum value, average value, and standard deviations are calculated automatically for each waveform parameter. In addition, you can instantaneously search for the cycle containing the maximum value and display it on the zoom screen. This cycle statistical calculation greatly improves your insight enabling you to analyze transient phenomena captured using the long recording memory.



## User-Defined Computation (with the /G2 Option)

### Perform Complex Calculations

The ScopeCorder comes standard with basic arithmetic operations (addition, subtraction, multiplication, division), FFT (power spectrum), and phase shifting (calculating a phase shift between channels). For more flexible and complex calculations, an optional (DL750/DL750P) userdefined computation package is available. With this option, you can define up to eight different formulas using a wide range of functions, including a triangle function, differentiation, integration, square root, digital filter, and seven different FFT functions. You can also specify the results of a calculation as a parameter in another formula.

With these capabilities, the DL750/DL750P makes it easy to perform complex calculations that, in the past, could only have been done by loading data onto a PC.



## GO/NO-GO Determination

### Automatic Waveform Determinations

With this function, the user specifies a zone or waveform parameter for a measured waveform. The measurement signal is evaluated and a specified action is performed automatically based on the evaluation. Available actions include outputting a screenshot to a specified destination, saving waveform data to a specified storage medium, sounding a buzzer, and sending email.



## X-Y Display Function

### Display an Overlay of up to Four X-Y Displays

This function lets you display multiple X-Y plots together, making relative phase comparisons easy. Simultaneous observation of X-Y waveforms and normal T-Y waveforms is possible. The X-Y display shows the range selected on the T-Y waveform. The X-Y display function is a powerful tool for applications such as evaluating DC motors based on a Lissajous waveform.

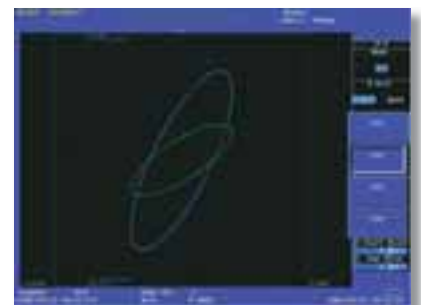

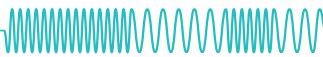

# A Wide Range of Trigger Functions for Accurately Capturing a Variety of Waveforms

Having a wide range of triggers is of course very useful for obtaining stable observations of variety of different waveforms. In addition, the GUI menu makes setting trigger conditions easy and intuitive.

## Simple and Enhanced Triggers

	<b>Edge trigger</b>	: Set a regular edge trigger. Trigger source : CH1~CH16, Logic A, Logic B, DSP1~DSP6*, EXT, LINE, Time	
	<b>A → B(N)</b>	: Triggers the N-th time that condition B goes true after condition A has gone true.	
	<b>A Delay B</b>	: Triggers if condition B goes true after condition A has gone true and an interval at least equal to the delay setting has elapsed.	
	<b>Edge on A</b>	: Activates an edge trigger on another input during the interval when trigger condition A is true.	
	<b>OR</b>	: Triggers when any one of the individual channel conditions set with the patterns goes true.	
	<b>B &gt; TIME</b>	: Triggers when the pulse width is longer than the set time.	
	<b>B &lt; TIME</b>	: Triggers when the pulse width is less than the time.	
	<b>B TIME OUT</b>	: Triggers when a preset time-out time is reached.	
	<b>Period</b>	: Triggers when a preset waveform frequency condition goes true.	
	<b>Window</b>	: Triggers when a trigger source enters or leaves a level set by two points.	
	<b>Wave Window</b>	: Triggers when a signal leaves an automatically-defined "wave window" that surrounds the waveform.	

\* : DL750/DL750P optional

## Wave Window Trigger

### Automatically Triggers on Abnormalities in Power Supply Waveforms

This function comes standard with the ScopeCorder to allow observation power supply waveforms. In addition to traditional power supply troubles, such as sudden outages, sags, and surges, you can make efficient real time observations of frequency fluctuations and voltage drops. This trigger activates when a signal exceeds the allowable values determined by comparing a defined waveform (wave window) with an actual waveform in real time. Comparative waveforms can be automatically produced in real time based on measured waveforms. Detection on all 16 analog channels is available (with OR conditions).

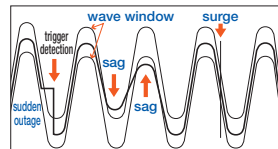

## Manual Trigger

### A Trigger Can Be Activated with Press of a Button.

With this feature, a trigger can be executed whenever you like, separate from the preset trigger conditions.



## Action-On Trigger

### Automatically Save Measured Data

When this trigger is activated, the ScopeCorder performs a specified action each time a waveform is captured and displayed on the screen. This feature is useful for saving data automatically and reliably (e.g., for data collection in automated, continuous tests).

#### Print the Screen Image Data (PRINT)

Prints the screen image data to a specified printer.

#### Save the Screen Image Data (Image)

Saves the screen image data to the save destination specified in the IMAGE SAVE menu.

#### Save Waveform Data (Save to File)

Saves the waveform data in binary, ASCII, or floating format to the save destination specified in the FILE menu.

#### Beep Sound (Buzzer)

Sounds a buzzer.

#### Send Mail

Sends an e-mail message to a specified address. (with the /C10 Option)

# History Memory and Smart Search for Effective Access to Large Amounts of Captured Data



## History Memory and History Search (Zone Search)

Occasionally, you may capture an abnormal waveform and then have it quickly disappear from the display as new data is acquired. It is not always possible to manually Start and Stop data acquisition to catch the abnormal waveform and have it displayed.

**The History Memory** function was designed for such situations. It divides long memory into a number of blocks and automatically stores up to 2000 previously captured waveforms. This means you can reliably save displayed waveforms to memory even when there are phenomena for which trigger conditions cannot be set.

**The Zone Search** function lets you define zones on the screen, and find all previously captured waveforms that either pass or don't pass through the user-defined zone. Up to four zones can be defined.

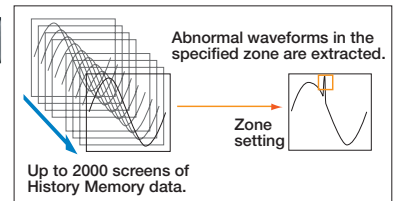

Up to 2000 screens of History Memory data.



## Search (Edge Search) and Zoom

DL750

DL750P

**The Edge Search** counts rising and falling edges in the captured data. It automatically searches for the desired edges and displays them on a zoom screen.

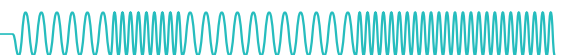

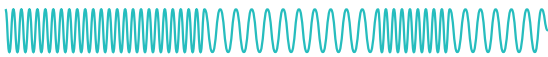

## Chart Recorder Function

SL1400 DL750P

### Access Settings Directly with the "RECORDER" Key\*



\* DL750P  
Mode key for SL1400

- Set chart speed, chart length, and other settings in menu just like a chart recorder
- Automatic recording to memory  
During real-time printing, the DL750P/SL1400 also automatically records the waveforms to memory in the background. Up to approximately 10 meters (1000 div) can be saved.
- "Reprint" function  
Once measurement completed, you can change the print format, length, or other parameters and print the data again. The Reprint function means never worrying about printer failure or running out of paper.
- Printout Example (A4 Size, High Resolution)

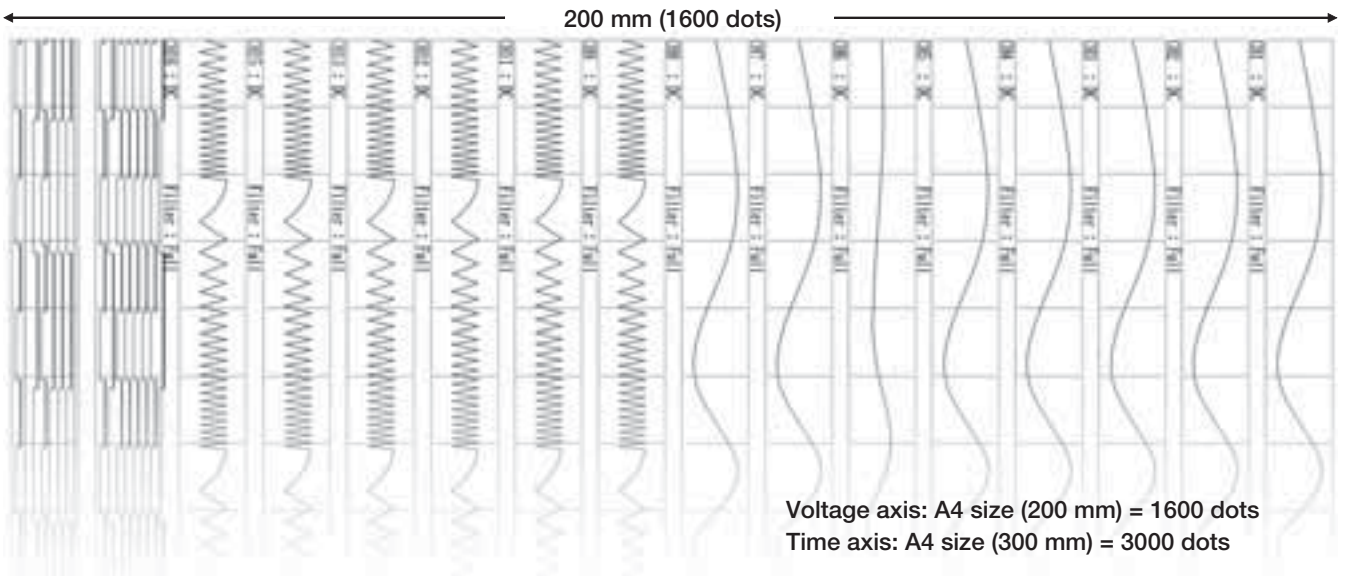

08

### Prints XY Plots in High Resolution

- Includes dedicated mode for emulating an XY recorder (XY Recorder mode)
- Prints A4 size plots (200 mm x 200 mm) in high resolution
- Prints up to 4 pairs (of waveforms) at the same time
- Replaces XY recorders



XY recorder

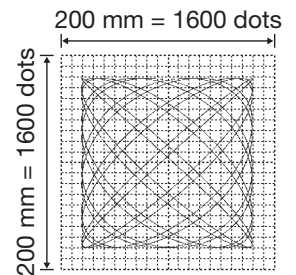

### PDF Output for Printing A4-Sized Reports

When performing on-site measurements, you can print out the data and hand-write memos on the paper. Since the DL750P/SL1400 simultaneously stores data to internal memory while printing, you can keep electronic and hard copy records with just a single action. (Remember that with thermal-sensible paper, it is vital to make photocopies for longterm preservation.)

The DL750P/SL1400 allows you to export results to files in PDF format, making it easy to save data for long periods of time, transfer the data to distant locations, or load them onto a PC. It is also easy to create reports since waveform data can be converted to an A4-size layout.



## Linear Scaling

### Convert Measured Voltage Values to Physical Values for Direct Reading

This function automatically performs the following calculation based on a scaling coefficient A and offset B:  
 $Y = AX + B$  (X is a measured value and Y is the scale value)  
 The results of this calculation are reflected in cursor measurement values and waveform parameter measurement values.  
 In addition, user-determined scale values can be defined for any two measurement, P1 and P2.

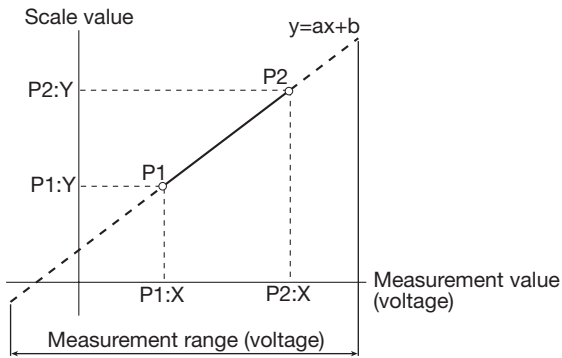

## Snapshot Function

### Enables On-Screen Waveform Comparisons

Using the snapshot function, you can keep the currently displayed waveform with the touch of a button. Snapshots are useful for comparing a reference waveform with an input waveform. In addition, snapshots can be saved to and loaded from the storage media.

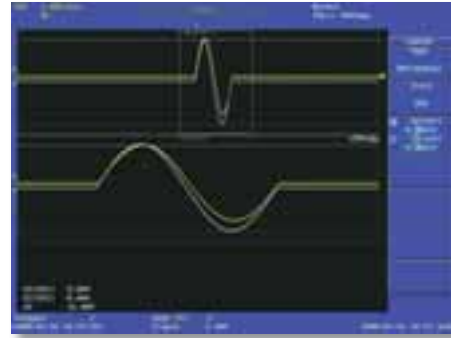

## IMAGE SAVE Key and Thumbnail Screen Images

Simply press the **IMAGE SAVE** key to save image data to a CompactFlash card or other storage media. The saved image data (PNG, JPEG, BMP, or PostScript format) can then be displayed on the ScopeCorder's screen as thumbnails.  
 The **PRINT** key lets you output images to the ScopeCorder's built-in printer, a USB printer, or a network printer.



Thumbnail display

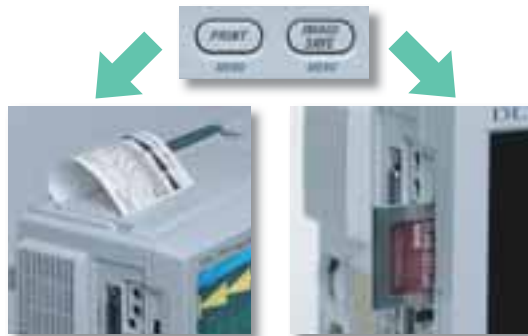

## Memory Backup Function

### Protects Your Data Even If the Power Supply Goes Out

This function backs up about 10 hours of data saved to the acquisition memory immediately prior to power loss. Memory backup helps you avoid losing important data even if the power supply is unstable and gets cut off. (Backup time varies according to the usage environment. Four AA batteries are required for memory backup.)



## Channel/All Channel Menus



Enter detailed settings for each channel including: coupling, range, position, and bandwidth limit filter. Pressing ALL CH lets you view and enter settings for all channels on a single screen.





## For AC & DC Input (with the /DC option)

### A Power Supply Backup System for Long Duration Observations\*

- Low Power Consumption 60-80 VA (typical value)
- Low Emission Noise

- Choose AC power, DC power, or both

**AC100V** (100-120V)  
**AC200V** (200-240V)

- Works with an external DC source such as a car battery

**DC12V** (10-18V)

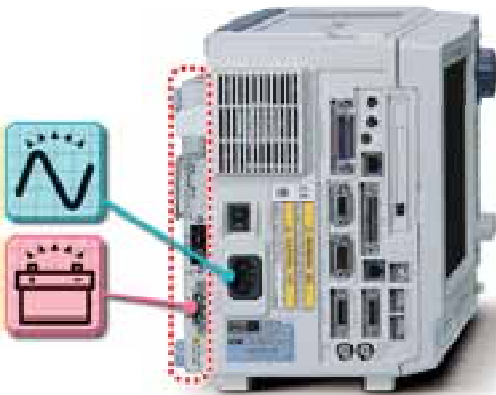

**Thin Profile**  
(Width: 20 mm, Weight: 800 g)

\* AC and DC power supplies can be used together to ensure a highly reliable power source. An external DC source such as a car battery is used for the DC power supply.

#### Three Power Supply Input Methods

##### 1. From a DC12V Battery

Using the 701971 DC Power Supply Cable (alligator clip type)



#### Accessory/Spare Parts

**701971**  
DC Power Supply Cable  
(alligator clip type), 1.8 m



##### 2. From a Car Cigarette Lighter

Using the 701970 DC Power Supply Cable (cigarette lighter type)



**701970**  
DC Power Supply Cable  
(cigarette lighter plug type), 1.8 m



##### 3. From an AC Power Supply

AC100-120 V/200-240 V



**B8023WZ**  
DC Power Supply Connector  
(without cable, D-sub 3 pin solder type)  
One connector comes standard with the option.

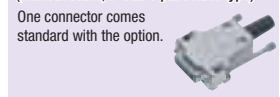

## Web Server Functions (with the /C10 option)

Connect the ScopeCorder to your PC through the Ethernet connection. This allows for easy remote operation using Internet Explorer.



#### FTP

You can easily copy and paste files to and from a PC and the instrument's flash memory or other storage media.



#### Measurement Trend

This function downloads values of waveform parameters periodically, launches MS Excel and graphs the parameters on a spreadsheet values. This enables you to check the parameter trends at a glance.



#### Data Capture

Using Internet Explorer, you can periodically or manually download screen images to a PC for remote waveform monitoring. You can also download waveform data, start or stop a measurement, or setup a split display all from a PC.

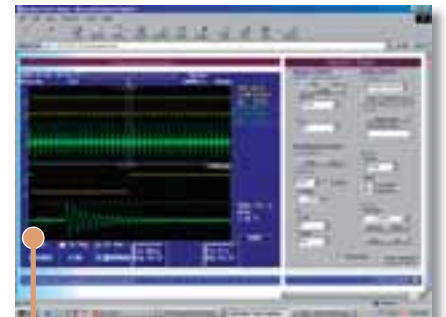

## Software (sold separately)

### Integrated Software: Supporting waveform Viewer, File transfer and Remote Control

#### Xviewer (701992)



Xviewer is a PC software application designed to work with Yokogawa's DL series digital oscilloscopes and ScopeCorder series. Xviewer allows you to display DL and SL-acquired waveform data (using the "Viewer" function), perform file transfers, and control DL and ScopeCorder series instruments remotely.

#### ■ Model Numbers and Suffix Codes

Model	Suffix code	Description
701992	-SP01	Xviewer Standard Edition (1 license)
	-GP01	Xviewer Math Edition (1 license)

\*: For detailed specifications, see the Xviewer catalog.

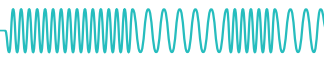

**DL750/DL750P/SL1400 Selection**

		DL750	DL750P	SL1400
Input Section	Number of input channels	16	16	16
	Logic input	●	●	●
	Long-memory	●	●	●
	DSP channel	●*1	●*1	—
Trigger Section	A wide range of trigger functions	●	●	●
Time Axis	Time axis setting	T/div*2	T/div*2	T*3
Vertical Axis	Voltage-axis sensitivity setting	V/div*4	V/div*4	V*5
Display Function	GIGAZoom ENGINE	●	●	●
	X-Y display	●	●	●
	Snapshot	●	●	●
Acquisition	Dual capture	●	●	—
	Realtime hard disk recording	●*6	●*6	●*6
	Voice memo	●	●	—
Vertical Axis Settings	ALL CH menu	●	●	●
	Linear scaling	●	●	●
Analysis	History memory & history search	●	●	●
	Search & zoom	●	●	—
	Automated measurement of waveform parameters, Statistical processing	●	●	●
	User-defined computation	●*1	●*1	—
	GO/NO-GO determination	●	●	—
Recorder Mode	Recorder mode (T-Y, X-Y)	—	●	●
Screen Image Data Output	Saving and printing the screen image data	●	●	●
Other Functions	Acquisition memory backup	●	●	●
	Action-on-trigger	●	●	●
	Multilingual menu (English/Japanese/Chinese/Korea)	●	●	●
	Multilingual message (eight languages)	●	●	●
Built-in Printer	Built-in printer	104 mm width	204 mm width	204 mm width
Built-in Storage	Floppy disk drive	●*7	●*7	—
	Zip drive	●*7	—	—
	PC card interface	●*7	●*7	●*1
	Internal hard disk	●*1	●*1	●*1
External Storage Interface	USB mass storage device	●	●	●
General Specifications	For AC & DC power input	●*1	—	—

\*1: optional \*2: The time per one grid square (1 div). The display span is 10 divisions. \*3: The length of time within one screen (= The record time)

\*4: The voltage value to one grid square (1 div) \*5: The voltage across the top and bottom edges of the waveform display area (10 divisions)

\*6: with the internal hard disk option \*7: Choose one.

**Module Selection**

Input	Model No.	Sample Rate	Resolution	Bandwidth	Number of Channels	Isolation	Maximum Input Voltage (DC+ACpeak)	DC Accuracy	Note
Analog Voltage	701250	10 MS/s	12-Bit	3 MHz	2	Isolated	600 V*2 250 V*3	±0.5%	high noise immunity
	701251	1 MS/s	16-Bit	300 kHz	2	Isolated	600 V*2 140 V*3	±0.25%	High sensitivity range (10 mV), low noise (±100µVtyp.), and high noise immunity
	701255	10 MS/s	12-Bit	3 MHz	2	Non-Isolated	600 V*4 250 V*3	±0.5%	non-isolation version of model 701250
	701260	100 kS/s	16-Bit	40 kHz	2	Isolated	1000 V*2 850 V*3	±0.25%	with RMS, and high noise immunity
Temperature	701261	100 kS/s (Voltage), 500 S/s (Temperature)	16-Bit (Voltage), 0.1°C (Temperature)	40 kHz (Voltage), 100 Hz (Temperature)	2	Isolated	42 V	±0.25% (Voltage)	thermocouple (K, E, J, T, L, U, N, R, S, B, W, iron-doped gold/chromel)
	701262	100 kS/s (Voltage), 500 S/s (Temperature)	16-Bit (Voltage), 0.1°C (Temperature)	40 kHz (Voltage), 100 Hz (Temperature)	2	Isolated	42 V	±0.25% (Voltage)	thermocouple (K, E, J, T, L, U, N, R, S, B, W, iron-doped gold/chromel), with AAF
	701265	500 S/s (Voltage), 500 S/s (Temperature)	16-Bit (Voltage), 0.1°C (Temperature)	100 Hz	2	Isolated	42 V	±0.08 (Voltage)	thermocouple (K, E, J, T, L, U, N, R, S, B, W, iron-doped gold/chromel), high sensitivity range ( 1 mV), and low noise (±4 µVtyp.)
Strain	701270	100 kS/s	16-Bit	20 kHz	2	Isolated	10 V	±0.5% (Strain)	Supports strain NDIS, 2, 5, 10 V built-in bridge power supply
	701271	100 kS/s	16-Bit	20 kHz	2	Isolated	10 V	±0.5% (Strain)	Supports strain DSUB, 2, 5, 10 V built-in bridge power supply, and shunt CAL
Analog Voltage, Acceleration	701275	100 kS/s	16-Bit	40 kHz	2	Isolated	42 V	±0.25% (Voltage) ±0.5% (Acceleration)	built-in anti-aliasing filter, Supports built-in amp type acceleration sensors (4 mA/22 V)
Frequency	701280	25 kS/s	16-Bit	resolution 50 ns	2	Isolated	420 V*2 42 V*3	±0.1% (Frequency)	Measurement frequency of 0.01 Hz to 200 kHz, Measured parameters (frequency, rpm, period, duty, power supply frequency, distance, speed)

\*1: Probes are not included with any modules.

\*2: In combination with 10:1 probe model 700929

\*3: Direct input

\*4: In combination with 10:1 probe model 701940

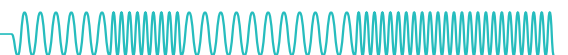

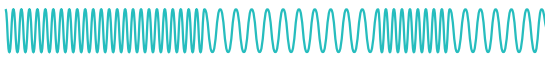

## Main Specifications (Main Unit)

		DL750	DL750P	SL1400
<b>Input Section</b>				
Type	Plug-in module (A/D converters built in to each unit)			
Number of slots	8			
Number of input channels	16 channels + 16-bit logic (8 bits x 2)			
Maximum sample rate	10 MS/s (Maximum sample rate differs depending on the type of module.)			
Max. recording length	2.5 MW/ch, 50 MW/(1ch) max. (Standard) 10 MW/ch, 250 MW/(1ch) max. (M1 option) 25 MW/ch, 500 MW/(1ch) max. (M2 option) 50 MW/ch, 1 GW/(1ch) max. (M3 option)		2.5 MW/ch, 50 MW/(1ch) max.	
<b>Trigger Section</b>				
Trigger mode	Auto, auto-level, normal, single, single(N), and log		Auto, auto-level, normal, single, single(N), log, and repeat (only in Chart Recorder mode)	
Simple trigger	Trigger source	CH1 to CH16, EXT, LINE, Logic A, Logic B, Time, and DSP1 to DSP6*1		CH1 to CH16, EXT, LINE, Logic A, Logic B, and Time
	Trigger slope	CH1 to CH16 and DSP1 to DSP6*1: Rising, falling, or rising/falling EXT, LOGIC A, LOGIC B: Rising or falling		CH1 to CH16: Rising, falling, or rising/falling EXT, Logic A, Logic B: Rising or falling
	Time trigger	Date (year/month/day), time (hour/minute), time interval (1 minute to 24 hours)		
Enhanced trigger	Trigger source	CH1 to CH16, Logic A, and Logic B (AND and OR possible on each logic bit)		
	Trigger type	A→B(N), A Delay B, Edge on A, OR, B > Time, B < Time, B Time Out, Period, Window, Wave Window*2		
<b>Time Axis</b>				
Setting range	500 ns/div to 1 s/div (in 1-2-5 steps), 2 s/div, 3 s/div, 4 s/div, 5 s/div, 6 s/div, 8 s/div, 10 s/div, 20 s/div, 30 s/div, 1 min/div to 10 min/div (in 1 min steps), 12 min/div, 15 min/div, 30 min/div, 1 h/div to 10h/div (in 1 h steps), 12 h/div, 1 day/div, 2 day/div, 3 day/div (The display span along the horizontal axis is 10 divisions.)		100 μs to 10 s (in 1-2-5 steps), 20 s, 30 s, 50 s, 60 s, 100 s, 200 s, 5 min, 10 min, 20 min, 30 min, 50 min, 60 min, 100 min, 120 min, 300 min, 10 h, 20 h, 30 h, 50 h, 100 h, 5 day, 10 day, 20 day, and 30 day (one screen)	
Time axis accuracy	±(0.005%) (Under standard operating conditions: ambient temperature: 23±5°C, Ambient humidity: 55±10% RH)			
External clock input	Connector type: RCA jack, Input level: TTL level (0 to 5 V), Frequency range: 1 MHz or less			
<b>Display</b>				
Display	10.4-inch color TFT LCD monitor, Effective display screen size 211.2 mm × 158.4 mm, Display resolution SVGA 800 × 600 dots*3			
Display resolution of the waveform display	650 × 512 (normal waveform display) or 750 × 512 (wide waveform display) selectable			
Display format	Zoom	MAIN, MAIN&Z1, MAIN&Z2, MAIN&Z1&Z2, Z1only, Z2only, and Z1&Z2		
	X-Y	TY, XY, and TY&XY		
Maximum display update rate	30 times/s when a single waveform is displayed			
<b>Function</b>				
<b>●Acquisition and Display</b>				
Acquisition mode	Normal:	Normal waveform acquisition		
	Envelope:	Maximum sample rate regardless of the record time, holds the peak value		
	Averaging:	Average count 2 to 65536 (2 <sup>n</sup> steps)		
	Box average:	Increase the A/D resolution up to 4 bits (16 bits max.)		
Zoom	Expand the displayed waveform along the time axis (up two locations using separate zoom rates)			
Display format	1, 2, 3, 4, 8, or 16 analog waveform windows			
X-Y display	Select the X axis and Y axis from CH1 to CH16, DSP1 to DSP6*1, MATH1 to MATH8 (up to 4)		Select the X axis and Y axis from CH1 to CH16, MATH1 to MATH8 (up to 4)	
Accumulation	Accumulates waveforms on the display (persistence mode)			
Snapshot	Retains the current displayed waveform on the screen. Snapshot waveforms can be saved and loaded.			
Dual capture	Performs data acquisition on the same waveform at two different sampling rates.			—
	Main waveform (low speed)	Maximum sample rate: 100 kHz (roll mode region) Maximum record length: 5 MW (Standard), 10 MW (M1 option), 50 MW (M2 option), 100 MW (M3 option)		—
Sub waveform (high speed)	Maximum sample rate: 10 MS/s Maximum record length: 10 kW (fixed) The number of sub waveforms that can be saved: 100 (Standard), 250 (M1 option), 500 (M2 and M3 option)			—
	Maximum sample rate	100 kS/s (for 2 ch)		
Realtime hard disk recording**	Capacity	Up to 1 GW per operation		
	Action count	Select Single or Continue. If Continue selected, set the count in the range of 2 to 128.		
Voice memo	Records a voice as a memo while waveforms are being acquired (when in roll mode display). The recorded voice memo can be saved along with the waveform data. Maximum record time is 100 s.		—	
Voice comment	Saves screen image data by attaching a voice comment (separate data from screen image data). The maximum length of voice comment that can be attached to a single screen image data is 10 s. Plays the voice comment from the File List window.		—	
<b>●Vertical/Horizontal Axis Settings</b>				
ALL CH menu	Set all channels while displaying waveforms. Operation using the USB keyboard and USB mouse is possible.			
Linear scaling	Set AX+B mode or P1-P2 mode independently for CH1 to CH16.			
Roll mode	The roll mode is enabled when the trigger mode is set to auto, auto-level, single, or log, and the display span along the time axis is greater than or equal to 1 s.			
<b>●Analysis</b>				
Auto scroll	Automatically scrolls the zoom position.			
Search & zoom function	Search for, then expand and display a portion of the displayed waveform.		—	
	Edge search/Voice search			
History search function	Search for and display waveforms from the history memory that satisfy specified conditions. Zone search/Parameter search			
Cursor measurement	Horizontal, Vertical, H&V, Degree (only for T-Y waveform display), and Marker			
Automated measurement of waveform parameters	Number of items	29 (Up to 24 items can be displayed)		
	Measurement parameters	P-P, Amp, Max, Min, High, Low, Avg, Mid, Rms, Sdev, +OvrShoot, -OvrShoot, Rise, Fall, Freq, Period, +Width, -Width, Duty, Pulse, Burst1, Burst2, AvgFreq, AvgPeriod, Int1TY, Int2TY, Int1XY, Int2XY, Delay (between channels)		

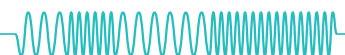

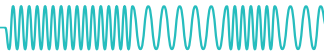

## Main Specifications (Main Unit)

		DL750	DL750P	SL1400
Statistical processing	Applicable items	Automated measured values of waveform parameters described above.		
	Statistics	Max, Min, Avg, Sdv, and Cnt		
	Maximum number of cycles	48000 cycles (when the number of parameters is 1)		
	Maximum total number of parameters	48000 (total number of results)		
	Maximum measurement range	10 MW		
	Mode	Normal statistical processing, Cyclic statistical processing, and Statistical processing of history data		
Computation	Definable MATH waveforms	8		
	Calculable record length	Up to 800 kW (MATH1 only), Up to 100 kW (MATH 1-8)		
	Operators (standard)	+, -, x, /, binary computation, phase shift, and power spectrum		
	User-defined computation <sup>5</sup>	ABS, SQRT, LOG, EXP, NEG, SIN, COS, TAN, ATAN, PH, DIF, DDIF, INTG, IINTG, BIN, P2, P3, F1, F2, FV, PWHL, PWLH, PWLL, PWXX, DUTYH, DUTYL, FILT1, FILT2, HLBT, MEAN, LS-, PS-, PSD-, CS-, TF-, CH-, MAG, LOGMAG, PHASE, REAL, IMAG		—
GO/NO-GO determination	Parameter	Determination using combinations of 16 waveform parameters.		
	Zone	Determination using combination of up to 6 waveform zones (AND, OR).		
	Actions	screen image data output, waveform data storage, buzzer notification, and e-mail transmission <sup>6</sup>		
<b>● DSP Channel Computation<sup>1*7</sup></b>				
Number of DSP channels	6			
Maximum computation rate	100 kS/s (6 channels simultaneously) (when exceeding 100 kS/s, the sampling rate is resampled at 100 kS/s)			—
Computation types	Calculation between channels (addition, subtraction, multiplication, and division), differentiation (with LPF), integration/summation, filters (LPF/HPF/BPF, FIR type/IIR type, variable cutoff frequency), knocking filter (filter calculations and bulb noise rejection function)			—
Cutoff frequency of filters	IIR type: 0.2% to 30% of sampling frequency, FIR type: 2% to 30% of sampling frequency			—
Calculation delay	4 sampling + digital filtering calculation delay			—
<b>● Recorder Mode</b>				
Realtime recording on the built-in printer	—	T-Y waveform recording/numeric value recording: Output to the chart in realtime. X-Y waveform recording: Starts data acquisition with START and generates X-Y waveforms in realtime. Outputs X-Y waveforms to the chart with STOP.		
Length of data saved to memory while realtime recording	—	T-Y waveform recording: Fixed to 2.5 MW Automatically saves up to 1000 divisions of data (depending on the chart speed). X-Y waveform recording: Fixed to 1 MW		
Recording start trigger	—	Recording can be started using a trigger by setting the trigger mode. Auto/Log/Single/Repeat		
Chart speed (T-Y waveform recording)	—	20 mm/s, 10 mm/s, 5 mm/s, 2 mm/s, 1 mm/s, 100 mm/min, 50 mm/min, 25 mm/min, 20 mm/min, 10 mm/min, 5 mm/min, 2 mm/min, 1 mm/min, 100 mm/h, 50 mm/h, 25 mm/h, 20 mm/h, or 10 mm/h		
Output interval (Numeric value recording)	—	1 s, 2 s, 5 s, 10 s, 15 s, 20 s, 30 s, 1 min, 2 min, 5 min, 10 min, 15 min, 20 min, 30 min, or 60 min		
Sample rate during X-Y waveform recording	—	5 kS/s, 2 kS/s, 1 kS/s, 500 S/s, 200 S/s, 100 S/s, 50 S/s, 20 S/s, 10 S/s, or 5 S/s		
Recording format	—	T-Y waveform recording: Select from 1, 2, 3, 4, 8, or 16 division recording (flexible zone is selectable for 1 division recording) Numeric value recording: Print direction selectable from standard and 180° rotation. X-Y waveform recording: Records up to 4 waveforms simultaneously. Assignment of X and Y channels on the 4 waveforms is arbitrary.		
Grid	—	Selectable from 1 div and 10 mm.		
Shot recording	—	Automatically stops when the specified length is recorded after the start of measurement or after the trigger condition is met. Shot recording length: Continuous, 20 cm, 50 cm, 1m, or 2 m		
External start/stop	—	Prints on a low signal. Stops printing on a high signal.		
Reprint function	—	An arbitrary section of the recorded data saved to the memory simultaneously with realtime print can be reprinted in an arbitrary format.		
Print image output	—	When performing reprint or fine print during T-Y waveform recording, the print image can be converted and output to a PDF file.		
Recorded contents	—	T-Y waveform recording: Scale, channel label, time print, gauge, annotation (channel information, message, data) X-Y waveform recording: Prints the scale value.		
<b>● Screen Image Data Output</b>				
Built-in printer	Prints a hard copy of the screen			
External printer	Outputs the screen image to an external printer via the USB PERIPHERAL terminal or the Ethernet network <sup>6</sup> . Supports ESC-P, ESC-P2, LIPS3, PCL5, BJ commands, and PostScript (only via the Ethernet network <sup>6</sup> )			
Storage	Output data format: PNG, JPEG, BMP, and PostScript			
<b>● Data Storage</b>				
History memory	Automatically holds up to 2000 pages of waveforms (depending on the memory length)			
Storage	Saves waveform data, setup data, snapshot waveform data, the results of the automated measurement of waveform parameters, and screen image data			
<b>● Acquisition Memory Backup</b>				
Batteries	4 AAA alkaline dry cells (AA/R6) (JIS, IEC model: LR6) or 4 nickel hydride rechargeable batteries			
Backup time (reference value)	Approx. 10 h (/M3 option), Approx. 15 h (/M2 option), Approx. 32 h (/M1 option), Approx. 150 h (standard)		Approx. 150 h	
Contents that are backed up	Acquisition memory waveform data (history memory data and sub waveform data of the dualcapture function) and voice memo data		Acquisition memory waveform data (history memory data)	
<b>● Other Functions</b>				
Action-on-trigger	Outputs screen image data, saves waveform data (binary, ASCII, or floating), activates buzzer notification, or sends e-mail messages <sup>6</sup> each time a trigger occurs.			
Menu language	Selectable from English, Japanese, Chinese, and Korean.			
Message language	Selectable from English, Japanese, Chinese, Korean, German, Italian, French, and Spanish.			
<b>Built-in printer</b>				
Print system	Thermal line dot system			
Paper width	112 mm	210 mm		
Effective printing width	104 mm (832 dots)	204 mm (1632 dots)		
Dot density	8 dots/mm			

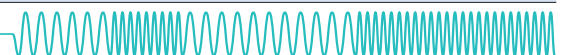

## Main Specifications (Main Unit)

	DL750	DL750P	SL1400
Feeding direction resolution	For normal print: 13 dots/mm. For fine (long) print: 10 dots/mm	For normal print: 8 dots/mm. For fine (long) print: 10 dots/mm	
Function	Normal print, fine print, and zoom print	Normal print, fine print, zoom print, A4 print, and realtime recording	
<b>Storage</b>			
Built-in storage	FDD, Zip drive, or PC card interface (choose one)	FDD or PC card interface (choose one)	PC card interface (optional)
Internal hard disk*4	40 GB		
External storage interface	SCSI/USB storage device		
<b>USB PERIPHERAL Interface</b>			
Specifications	Conforms to USB Rev.1.1 x 2, compatible devices: keyboard, printer, mouse, and mass storage device		
<b>Auxiliary I/O Section</b>			
Logic input	26-pin half-pitch connector (8 bits) x 2, maximum sample rate: 10 MS/s		
External trigger input	RCA jack x 1, TTL (0 to 5 V) input		
Trigger output	RCA jack x 1 (shared with the external sampling clock), CMOS level (0 to 5 V) output		
Video signal output	15-pin D-Sub receptacle x 1, analog RGB output, output resolution: SVGA output 800 x 600 dots/60 Hz Vsync		
GO/NO-GO determination I/O	Modular jack (RJ-11) x 1, compatible cable: 366973 START IN input: TTL (0 to 5 V) or switch input, GO-OUT/NOGO-OUT: CMOS (0 to 5 V)		—
External start/stop	Shared with the GO/NO-GO start terminal (used exclusively). TTL (0 to 5 V) or switch input		Modular jack (RJ-11) x 1, TTL (0 to 5 V) or switch input
COMP output (rectangular signal output for probe compensation)	1 kHz $\pm$ 1%, 1 V $\pm$ 10%		
Voice input/output	Compatible earphone microphone: earphone microphone with a PUSH switch: 701951		—
Speaker output	Shared with the GO/NO-GO determination I/O (used exclusively). compatible cable: 701952		—
Probe power output*8	4, compatible probes: current probe including 701933 (30 A)/701930 (150 A)/701930 (500A).		
<b>Computer Interface</b>			
Specifications	GP-IB, Serial (RS-232), USB (Rev.1.1), Ethernet (100BASE-TX/10BASE-T)*6		
Supported services	USB	Remote control	
	Ethernet*6	FTP server, FTP client (network drive), LPR client (network printer), SMTP client (mail transmission), DHCP, DNS, Web server, and remote control	
<b>General Specifications</b>			
Rated supply voltage	100 to 120 VAC or 200 to 240 VAC (automatic switching)		
Rated power supply frequency	50/60 Hz		
Maximum power consumption	Approx. 200 VA max.		
Withstand voltage	1500 VAC between power supply and earth for 1 minute		
Insulation resistance	10 M $\Omega$ or higher at 500 VDC between power supply and earth		
External dimensions (excluding the handle and other projections)	355 mm (W) x 250 mm (H) x 180 mm (D)	355 mm (W) x 250 mm (H) x 225 mm (D)	355 mm (W) x 250 mm (H) x 225 mm (D)
Weight	Approx. 6.6 kg (only the DL750 with all options (/M3/C8/C10/P4 options)) Approx. 10.6 kg (DL750 + 701250 x 8)	Approx. 7.8 kg (only the DL750P with all options (/M3/C8/C10/P4 options)) Approx. 11.8 kg (DL750P + 701250 x 8)	Approx. 7.8 kg (only the SL1400 with all options (/C8/C10/P4 options)) Approx. 11.8 kg (SL1400 + 701250 x 8)
Operating temperature range	5 to 40 °C		
DC option	Supply format	Auto DC/AC switching (AC preferred), isolation between DC power input terminal and the DL750	—
	Rated supply voltage	12 VDC	—
	Permitted supply voltage	10 to 18 VDC	—
	Maximum power consumption	Approx. 120 VA Max.	—
	Voltage input protection circuit	Overcurrent detection: Breaker (15 A) Reverse connection protection: Breaker shutdown Undervoltage detection: Cut off at a voltage less than approx. 9.5 V Overvoltage detection: Cut off at a voltage greater than approx. 18 V	—
	Withstand voltage	30 VAC between the DC power terminal and earth for 1 minute	—
	Insulation resistance	10 M $\Omega$ or higher at 500 VDC between the DC power terminal and earth	—
	External dimensions (including DL750)	355 mm (W) x 250 mm (H) x 200 mm (D) (excluding the handle and other projections)	—
	DC Power Box weight	Approx. 800 g	—

\*1: with the /G3 option \*2: Operating conditions of the wave window trigger: Target waveform: AC waveform or triangular waveform between 40 and 1 kHz / Acquisition mode: Normal / Trigger mode: Normal, Single, or Single(N) / Sample rate: 10 kS/s to 500 kS/s Applicable modules: 701250/51/55/60/70/71/75 and 701261/62 (only when measuring voltage), The wave window trigger cannot be used when the dual capture function is ON. \*3: Liquid crystal display may include few defective pixels. There may be pixels that do not turn ON or those that remain ON at all times. However, these cases are not considered malfunctions. \*4: with the /C8 option \*5: with the /G2 option \*6: with the /C10 option \*7: The maximum sample rate of analog channels is 5 MS/s when a DSP channel is turned ON. \*8: with the /P4 option

## Main Specifications (plug-in modules)

\*1: Under standard operating conditions (temperature of 23 °C  $\pm$  5 °C, 55%  $\pm$  10% RH, warm-up of 30 min. or more), after calibration. Recommended calibration period: 1 year. Note that the strain modules (701270/71) must be balanced.

\*2-11 See the figure on page 19 for notes on the maximum input voltage and maximum allowable common mode voltage.

\*12: See the figure on page 18 for the voltage-axis sensitivity setting.

### High-Speed 10 MS/s, 12-Bit Isolation Module (701250)

Input channels	2
Input type	Isolated unbalanced
Input coupling	AC, DC, and GND
Input connector	BNC connector (isolated type)
Input impedance	1 M $\Omega$ $\pm$ 1%, approx. 35 pF
Maximum sample rate	10 MS/s
Frequency range (-3dB)*1	DC to 3 MHz
A/D conversion resolution	12-bit (150 LSB/div)
Voltage-axis sensitivity setting*12	5 mV/div to 20 V/div (1-2-5 steps)

Maximum input voltage (1 kHz or less)	
In combination with 700929 (10:1)*2	600 V (DC+ACpeak)
In combination with 701901+701954 (1:1)*6	250 V (DC+ACpeak)
Direct input*10	250 V (DC+ACpeak)
Maximum allowable common mode voltage (1 kHz or less)	
In combination with 700929 (10:1)*3	400 Vrms (CAT I), 300 Vrms (CAT II)
In combination with 701901+701954 (1:1)*9	400 Vrms (CAT I), 300 Vrms (CAT II)
Direct input*11	42 V (DC+ACpeak)(CAT I and CAT II, 30 Vrms)
Vertical (voltage) axis accuracy*1	
DC accuracy	$\pm$ (0.5% of 10 div)
Temperature coefficient	

## Main Specifications (plug-in modules)

Zero point	$\pm(0.05\%$ of 10 div)/ °C (Typ.)
Gain	$\pm(0.02\%$ of 10 div)/°C (Typ.)
Bandwidth limit	OFF/500 Hz/5 kHz/50 kHz/500 kHz

### High-Speed 1 MS/s, 16-Bit Isolation Module (701251)

Input channels	2
Input type	Isolated unbalanced
Input coupling	AC, DC, and GND
Input connector	BNC connector (isolated type)
Input impedance	1 M $\Omega$ $\pm$ 1%, approx. 35 pF
Maximum sample rate	1 MS/s
Frequency range (-3dB)* <sup>1</sup>	DC to 300 kHz (5 mV/div to 20 V/div) DC to 200 kHz (1 mV/div, 2 mV/div)
A/D conversion resolution	16-bit (2400 LSB/div)
Voltage-axis sensitivity setting* <sup>12</sup>	1 mV/div to 20 V/div (1-2-5 steps)
Maximum input voltage (1 kHz or less)	
In combination with 700929 (10:1)* <sup>2</sup>	600 V (DC+ACpeak)
In combination with 701901+701954 (1:1)* <sup>6</sup>	140 V (DC+ACpeak)
Direct input* <sup>10</sup>	140 V (DC+ACpeak)
Maximum allowable common mode voltage (1 kHz or less)	
In combination with 700929 (10:1)* <sup>3</sup>	400 Vrms (CAT I), 300 Vrms (CAT II)
In combination with 701901+701954 (1:1)* <sup>9</sup>	400 Vrms (CAT I), 300 Vrms (CAT II)
Direct input* <sup>11</sup>	42 V (DC+ACpeak)(CAT I and CAT II, 30 Vrms)
Vertical (voltage) axis accuracy* <sup>1</sup>	
DC accuracy	5 mV/div to 20 V/div : $\pm(0.25\%$ of 10 div) 2 mV/div : $\pm(0.3\%$ of 10 div) 1 mV/div : $\pm(0.5\%$ of 10 div)
Temperature coefficient	
Zero point	5 mV/div to 20 V/div : $\pm(0.02\%$ of 10 div)/°C(Typ.) 2 mV/div : $\pm(0.05\%$ of 10 div)/°C (Typ.) 1 mV/div : $\pm(0.10\%$ of 10 div)/°C (Typ.)
Gain	1 mV/div to 20 V/div : $\pm(0.02\%$ of 10 div)/°C (Typ.)
Bandwidth limit	OFF/400 Hz/4 kHz/40 kHz

### High-Voltage 100 kS/s, 16-Bit Isolation Module (with RMS) (701260)

Input channels	2
Input type	Isolated unbalanced
Input coupling	AC, DC, GND, AC-RMS, and DC-RMS
Input connector	BNC connector (isolated type)
Input impedance	1 M $\Omega$ $\pm$ 1%, approx. 35 pF
Maximum sample rate	100 kS/s
Frequency range (-3dB)* <sup>1</sup>	
Waveform observation mode	DC to 40 kHz
RMS observation mode	DC, 40 Hz to 10 kHz
A/D conversion resolution	16-bit (2400 LSB/div)
Voltage-axis sensitivity setting* <sup>12</sup>	20 mV/div to 200 V/div (1-2-5 steps)
Maximum input voltage (1 kHz or less)	
In combination with 700929 (10:1)* <sup>2</sup>	1000 V (DC+ACpeak)
In combination with 701901+701954 (1:1)* <sup>6</sup>	850 V (DC+ACpeak)
Direct input* <sup>10</sup>	850 V (DC+ACpeak)
Maximum allowable common mode voltage (1 kHz or less)	
In combination with 700929 (10:1)* <sup>3</sup>	H side: 1000 Vrms (CAT II)* <sup>4</sup> , L side: 400 Vrms (CAT II)* <sup>5</sup>
In combination with 701901+701954 (1:1)* <sup>9</sup>	H side: 700 Vrms (CAT II)* <sup>7</sup> , L side: 400 Vrms (CAT II)* <sup>8</sup>
Direct input	H/L sides: 30 Vrms (42 VDC+ACpeak)* <sup>11</sup>
Vertical (voltage) axis accuracy* <sup>1</sup>	
Waveform observation mode	DC accuracy $\pm(0.25\%$ of 10 div)
RMS observation mode	DC accuracy $\pm(1.0\%$ of 10 div)
AC accuracy (sinewave input)	$\pm(1.5\%$ of 10 div) At frequency of 40 Hz to 1 kHz
AC accuracy (crest factor 2 or less)	$\pm(2.0\%$ of 10 div) At frequency of 40 Hz to 1 kHz
AC accuracy (crest factor 3 or less)	$\pm(3.0\%$ of 10 div) At frequency of 40 Hz to 1 kHz
Temperature coefficient (Waveform observation mode)	
Zero point	$\pm(0.02\%$ of 10 div)/°C (Typ.)
Gain	$\pm(0.02\%$ of 10 div)/°C (Typ.)
Bandwidth limit	OFF/100 Hz/1 kHz/10 kHz
Response time (RMS observation mode)	
Rising (0 to 90% of 10 div)	100 ms (Typ.)
Falling (100 to 10% of 10 div)	250 ms (Typ.)

### Frequency Module (701280)

Measurement function	Frequency (Hz), RPMs, RPSs, period (sec), duty cycle (%), power supply frequency (Hz), pulse
----------------------	--

Input channels	width (sec), pulse integration, and velocity
Input type	2
Input coupling	Isolated unbalanced
Input connector	AC and DC
Input impedance	BNC connector (isolated type)
	1 M $\Omega$ $\pm$ 1%, approx. 35 pF
	Pull-up function: 4.7 k $\Omega$ , approx. 5 V (pull-up can be turned ON only when the input is set to Pull-Up 5V)
Data update rate	25 kHz (40 $\mu$ s)
Minimum measurement resolution	50 ns
Measured data resolution	16-bit (2400 LSB/div)
Input voltage range ( $\pm$ FS)	(1:1) $\pm$ 1 V to $\pm$ 50 V (1-2-5 steps)
Maximum input voltage	
In combination with 700929 (10:1)* <sup>2</sup>	420 V (DC+ACpeak)
Direct input* <sup>10</sup>	42 V (DC+ACpeak)
Maximum allowable common mode voltage	
In combination with 700929 (10:1)* <sup>3</sup>	300 Vrms (CAT I and CAT II)
Direct input* <sup>11</sup>	L side: 30 Vrms (CAT I and CAT II)
Bandwidth limit	OFF/100 Hz/1 kHz/10 kHz/100 kHz
Comparator section	
Preset function	Logic (5 V/3 V/12 V/24 V), electromagnetic pickup, zero crossing, pull-up (5 V), AC100 V, AC 200 V, and user-defined
Threshold range	$\pm$ FS range, resolution 1% units
Hysteresis	$\pm$ 1%, $\pm$ 2.5%, $\pm$ 5 % of FS
Chatter elimination function	OFF or 1 ms to 1000 ms (1 ms resolution)
LED display (per CH)	
ACT (green)	Operating status (lights during pulse input)
OVER (red)	Overdrive status (lights when input exceeds range)

#### Measured parameters and measuring range

Measured parameter	Measuring Range	Vertical axis sensitivity setting
Frequency (Hz)	0.01 Hz to 200 kHz	0.1 Hz/div to 50 kHz/div
RPMs	0.01 rpm to 100,000 rpm	0.1 rpm/div to 10 krpm/div
RPSs	0.001 rps to 2000 rps	0.01 rps/div to 200 rps/div
Period (sec)	5 $\mu$ s to 50 s	10 $\mu$ s/div to 5 s/div
Duty cycle (%)	0% to 100%	1%/div to 20%/div
Power supply frequency (Hz)	(50 Hz, 60 Hz, 400 Hz) $\pm$ 20 Hz	0.1 Hz/div to 2 Hz/div
Pulse width (sec)	2 $\mu$ s to 50 s	10 $\mu$ s/div to 5 s/div
Pulse integration	Up to 2 x 10 <sup>9</sup> pulses	10 x 10 <sup>21</sup> value/div to 0.5 x 10 <sup>21</sup> value/div
Velocity	Measuring range same as frequency (units can be converted to km/h, etc.)	

#### Measurement accuracy\*<sup>1</sup>

- When in frequency, RPM, RPS, or velocity measurement mode
  - Measurement accuracy
  - $\pm(0.05\%$  of 10 div + accuracy dependent on the input frequency)
  - Accuracy dependent on the input frequency
  - 2 kHz or less      0.05% of the input frequency + 1 mHz
  - 2 kHz to 10 kHz    0.1% of the input frequency
  - 10 kHz to 20 kHz    0.3% of the input frequency
  - 20 kHz or higher    0.5% of the input frequency
- When in period measurement mode
  - Measurement accuracy
  - $\pm(0.05\%$  of 10 div + accuracy dependent on the input frequency)
  - Accuracy dependent on the input period
  - 500  $\mu$ s or greater    0.05% of the input period
  - 100  $\mu$ s to 500  $\mu$ s    0.1% of the input period
  - 50  $\mu$ s to 100  $\mu$ s     0.3% of the input period
  - 50  $\mu$ s or less        0.5% of the input period + 0.1  $\mu$ s
- When in duty cycle measurement mode
  - Accuracy dependent on the input frequency
  - 1 kHz or less         $\pm$ 0.1%
  - 1 kHz to 10 kHz      $\pm$ 0.2%
  - 10 kHz to 50 kHz     $\pm$ 1.0%
  - 50 kHz to 100 kHz    $\pm$ 2.0%
  - 100 kHz to 200 kHz  $\pm$ 4.0%
- When in pulse width measurement mode
  - Measurement accuracy
  - $\pm(0.05\%$  of 10 div + accuracy dependent on the input pulse width)
  - Accuracy dependent on the input pulse width
  - 500  $\mu$ s or greater    0.05% of the input pulse width
  - 100  $\mu$ s to 500  $\mu$ s    0.1% of the input pulse width
  - 50  $\mu$ s to 100  $\mu$ s     0.3% of the input pulse width
  - 50  $\mu$ s or less        0.5% of the input pulse width + 0.1  $\mu$ s
- When in power supply frequency mode
  - Measurement accuracy
  - When the center frequency is 50/60 Hz:  $\pm$ 0.03 Hz (0.01 Hz resolution)
  - When the center frequency is 400 Hz:  $\pm$ 0.3 Hz (0.01 Hz resolution)

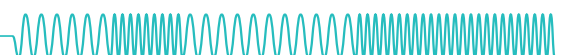

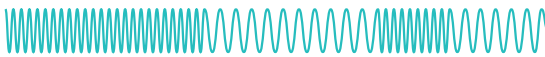

## Main Specifications (plug-in modules)

### Auxiliary measurement functions

Deceleration prediction	Computes the deceleration condition in realtime when the pulse input is cut off. Can be specified when measuring the frequency, RPMs, RPSs, period, and velocity.
Stop prediction	Sets the frequency to 0 after a certain time elapses after the pulse input is cut off. Stop interval setting: Set in the range of 1.5 to 10 times (10 settings) the period of the pulse measured last. Can be specified when measuring the frequency, RPMs, RPSs, period, and velocity.
Smoothing	Computes the moving average of the measured data using the specified time. Specified time: 0.1 to 1000 ms (0.1 ms resolution). Can be specified on all measurement parameters.
Pulse average	Performs frequency measurement per specified number of pulses. When fluctuation exists periodically in the pulse interval, the fluctuation can be eliminated. Specified number of pulses: 1 to 4096. Can be specified when measuring the frequency, RPMs, RPSs, power supply frequency, period, pulse integration, and velocity.
Offset function	Observe fluctuation with respect to the offset frequency. Offset range: Can be set up to 100 times the maximum range value.

### High-Speed 10 MS/s, 12-Bit Non-Isolation Module (701255)

Input channels	2
Input type	Non-isolated, unbalanced
Input coupling	AC, DC, and GND
Input connector	BNC connector (metallic type)
Input impedance	1 MΩ±1%, approx. 35 pF
Maximum sample rate	10 MS/s
Frequency range (-3dB)*1	DC to 3 MHz
A/D conversion resolution	12-bit (150 LSB/div)
Voltage-axis sensitivity setting*12	5 mV/div to 20 V/div (1-2-5 steps)
Maximum input voltage (1 kHz or less)	
In combination with 701940 (10:1)	600 V (DC+ACpeak)
Direct input	250 V (DC+ACpeak)
Vertical (voltage) axis accuracy*1	
DC accuracy	±(0.5% of 10 div)
Temperature coefficient	
Zero point	±(0.05% of 10 div)/°C (Typ.)
Gain	±(0.02% of 10 div)/°C (Typ.)
Bandwidth limit	OFF/500 Hz/5 kHz/50 kHz/500 kHz

### Acceleration/Voltage Module (with AAF) (701275)

Input channels	2
Input type	Non-isolated, unbalanced
Input coupling	AC, DC, ACCL (acceleration), and GND
Input connector	BNC connector (metallic type)
Input impedance	1 MΩ±1%, approx. 35 pF
Maximum sample rate	100 kS/s
Frequency range (-3dB)*1	(Acceleration) 0.4 Hz to 40 kHz (Voltage) DC to 40 kHz
A/D conversion resolution	16-bit (2400 LSB/div)
Voltage-axis sensitivity setting*12	
Acceleration (±5 V = x1 range)	x0.1 to x1 to x100 (1-2-5 steps)
Voltage	5 mV/div to 10 V/div (1-2-5 steps)
Maximum input voltage (1 kHz or less)*10	42 V (DC+ACpeak)
Maximum allowable common mode voltage (1 kHz or less)*11	30 Vrms (CAT I and CAT II)
Vertical (voltage) axis accuracy*1	Voltage (DC accuracy) ±(0.25% of 10 div) Acceleration ±(0.5% of range) at 1 kHz
Temperature coefficient (voltage) (excluding AUTO filter)	
Zero point	±(0.02% of 10 div)/°C (Typ.)
Gain	±(0.02% of 10 div)/°C (Typ.)
Bandwidth limit	OFF/Auto (AAF)/40 Hz/400 Hz/4 kHz
Anti-aliasing filter (AAF)	
Cutoff frequency (fc)	automatically linked with the sampling frequency (fs) fs ≥ 100 Hz : fc = fs x 40% fs ≤ 50 Hz : fc = 20 Hz
Cutoff characteristics	-65 dB at 2 x fc (Typ.)
Sensor supply current (voltage)	OFF/4 mA ± 10% (approx. 22 VDC)
Applicable acceleration sensor	
Built-in amplifier type	
Kistler Instruments Corp. :	Piezotron™, PCB
Piezotronics Inc. :	ICP™, Endevco Corp : Isotron™, etc.

### Strain Module (NDIS) (701270) / Strain Module (DSUB, Shunt-Cal) (701271)

Input channels	2
Input type	DC bridge (auto balancing), balanced differential input, and isolated
Auto balance type	Electronic auto balance

Auto balance range	±10,000 μSTR (1 gauge method)
Bridge voltage	Select from 2 V, 5 V, and 10 V.
Gauge resistance	120 Ω to 1000 Ω (bridge voltage: 2 V) 350 Ω to 1000 Ω (bridge voltage: 2 V, 5 V, and 10 V)
Gauge factor	1.90 to 2.20 (set in 0.01 steps)
Maximum sample rate	100 kS/s
Frequency range (-3dB)*1	DC to 20 kHz
A/D conversion resolution	16-bit (4800 LSB/div: Upper = +FS, Lower = -FS)
mV/V range support	mV/V range = 0.5 x (μSTR range/1000)
Measurement range/measurable range	
Measurement range (FS)	Measurable range (-FS to +FS)
500 μSTR	-500 μSTR to +500 μSTR
1000 μSTR	-1000 μSTR to +1000 μSTR
2000 μSTR	-2000 μSTR to +2000 μSTR
5000 μSTR	-5000 μSTR to +5000 μSTR
10,000 μSTR	-10,000 μSTR to +10,000 μSTR
20,000 μSTR	-20,000 μSTR to +20,000 μSTR

Maximum input voltage (1 kHz or less)	10 V (DC+ACpeak)
Maximum allowable common mode voltage (1 kHz or less)	42 V (DC+ACpeak)(CAT I and CAT II, 30 Vrms)
DC accuracy*1	±(0.5% of FS + 5 μSTR)
Temperature coefficient	
Zero point	±5 μSTR/°C (Typ.)
Gain	±(0.02% of FS)/°C (Typ.)
Bandwidth limit	OFF/10 Hz/100 Hz/1 kHz
• NDIS (701270)	
Function	mV/V support. Supports the strain gauge transducer unit system.
Input connector	NDIS connector (Recommended by JSNDI (The Japanese Society for Non-destructive Inspection))
Standard accessories	NDIS connector : 2 pieces
Recommended bridge head	(sold separately) 701955 (NDIS 120 Ω, comes with a 5-m cable) 701956 (NDIS 350 Ω, comes with a 5-m cable)
• DSUB, Shunt-Cal (701271)	
Function	mV/V support.
Supports	the strain gauge transducer unit system. Shunt calibration support. Built-in shunt calibration relay (1 gauge method).
Input connector	9-pin D-Sub connector (female)
Standard accessories	Connector shell set for soldering : 2 sets
Recommended bridge head	(supports DSUB shunt-Cal) (sold separately) 701957 (D-Sub 120 Ω, comes with a 5-m cable) 701958 (D-Sub 350 Ω, comes with a 5-m cable)

### Universal (Voltage/Temp.) Module (701261) / with AAF (701262)

Function	Temperature (thermocouple) or voltage measurement (switchable)	
Input channels	2	
Input type	Isolated unbalanced	
Input coupling	TC (thermocouple), DC, AC, and GND	
Input connector	Binding post	
Input impedance	Approx. 1 MΩ	
Maximum sample rate	Voltage 100 kS/s	
Data update rate	Temperature 500 Hz	
Frequency range (-3dB)*1	Voltage DC to 40 kHz Temperature DC to 100 Hz	
Vertical resolution	Voltage 16-bit (2400 LSB/div) Temperature 0.1°C	
Measurement range/accuracy*1		
Voltage measurement		
Voltage-axis sensitivity setting*12	5 mV/div to 20 V/div (1-2-5 steps)	
Vertical (voltage) axis accuracy	±(0.25% of 10 div)	
Temperature measurement		
(Does not include the reference junction temperature compensation accuracy.)		
Type	Measurement Range	Accuracy
K	-200°C to 1300°C	±(0.1% of reading + 1.5°C)
E	-200°C to 800°C	Except ±(0.2% of reading + 1.5°C)
J	-200°C to 1100°C	for -200°C to 0°C
T	-200°C to 400°C	
L	-200°C to 900°C	
U	-200°C to 400°C	
N	0°C to 1300°C	
R	0°C to 1700°C	±(0.1% of reading + 3°C)
S	0°C to 1700°C	Except, 0 to 200°C: ±8°C 200°C to 800°C: ±5°C



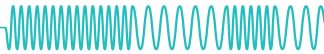

## Main Specifications (plug-in modules)

Type	Measurement Range	Accuracy
B	0°C to 1800°C	±(0.1% of reading + 2°C) Except, 400°C to 700°C: ±8°C Effective range is 400°C to 1800°C
W	0°C to 2300°C	±(0.1% of reading + 3°C)
Au7Fe3	0K to 300K	0K to 50K: ±4K 50K to 300K: ±2.5K

Maximum input voltage (1 kHz or less)  
42 V (DC + ACpeak) (as a value that meets the safety standard)  
150 V (DC + ACpeak) (maximum allowable voltage, as a value that does not damage the instrument when applied)

Maximum allowable common mode voltage (1 kHz or less)  
42 V (DC+ACpeak) (CAT I and CAT II, 30 Vrms)

### Temperature coefficient (Voltage)

Zero point  
Gain

Bandwidth limit  
Voltage  
Temperature

Anti-aliasing filter (AAF)(701262 only)  
Cutoff frequency (fc)

Frequency range (-3dB)\*1  
Vertical resolution  
DC to 100 Hz  
Voltage  
Temperature  
16-bit (2400 LSB/div)  
0.1 °C

Measurement range/accuracy\*1  
Voltage measurement  
Voltage-axis sensitivity setting\*12  
Vertical (voltage) axis accuracy  
Temperature measurement  
(Does not include the reference junction temperature compensation accuracy.)

Type	Measurement Range	Accuracy
K	-200°C to 1300°C	±(0.1% of reading + 1.5°C)
E	-200°C to 800°C	Except ±(0.2% of reading + 1.5°C) for -200°C to 0°C
J	-200°C to 1100°C	
T	-200°C to 400°C	
L	-200°C to 900°C	
U	-200°C to 400°C	
N	0°C to 1300°C	
R	0°C to 1700°C	±(0.1% of reading + 3°C)
S	0°C to 1700°C	Except, 0 to 200°C: ±8°C 200°C to 800°C: ±5°C
B	0°C to 1800°C	±(0.1% of reading + 2°C) Except, 400°C to 700°C: ±8°C Effective range is 400°C to 1800°C
W	0°C to 2300°C	±(0.1% of reading + 3°C)
Au7Fe3	0K to 300K	0K to 50K: ±4K 50K to 300K: ±2.5K

Maximum input voltage (1 kHz or less)  
42 V (DC + ACpeak)

Maximum allowable common mode voltage (1 kHz or less)  
42 V (DC+ACpeak) (CAT I and CAT II, 30 Vrms)

Temperature coefficient (Voltage)  
Zero point  
Gain

Bandwidth limit  
OFF/2 Hz/8 Hz/30 Hz

### Temperature, High Precision Voltage Isolation Module (701265)

Function  
Input channels  
Input type  
Input coupling  
Input connector  
Input impedance  
Data update rate

## Main Specifications (probes)

### 10:1 Probe (for Isolated BNC Input) (700929)

Frequency range (-3 dB)  
Attenuation ratio  
Input impedance/capacitance  
Maximum input voltage (probe alone)

### Current Probe (701933)

Frequency range (-3 dB)  
Maximum continuous input range  
Maximum peak current  
Output voltage rate  
Amplitude accuracy

### Current Probe (701930)

Frequency range (-3 dB)  
Maximum continuous input range  
Maximum peak current  
Output voltage rate  
Amplitude accuracy

### Current Probe (701931)

Frequency range (-3 dB)  
Maximum continuous input range  
Maximum peak current  
Output voltage rate  
Amplitude accuracy

### Differential Probe (700924)

Frequency range (-3 dB)  
Attenuation ratio  
Input impedance/capacitance  
Differential allowable voltage

### Passive Probe (701940)

Frequency range (-3 dB)  
Attenuation ratio  
Input impedance/capacitance  
Maximum input voltage (probe alone)

### Logic Probe (702911 : 1 m and 702912 : 3 m) \* Specific to the SL1400

Number of inputs  
Input type  
Maximum input voltage  
Response time  
Input impedance  
Threshold level  
Input level

### High-Speed Logic Probe (700986)

Number of inputs  
Input type  
Maximum input voltage (1 kHz or less)(across probe tip and earth)  
Response time  
Input impedance  
Threshold level

### Isolation Logic Probe (700987)

Number of inputs  
Input type  
Input connector  
Input switching  
Applicable input range  
Threshold level  
Response time  
Maximum input voltage (1 kHz or less)(across H and L of each bit)  
Maximum allowable common mode voltage (1 kHz or less)  
Maximum allowable voltage between bits  
Input impedance

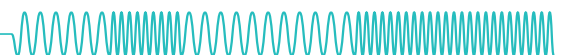

**Example of accessory combinations**

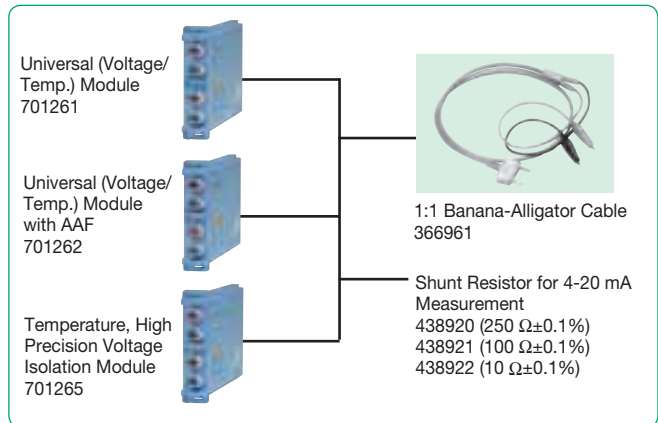
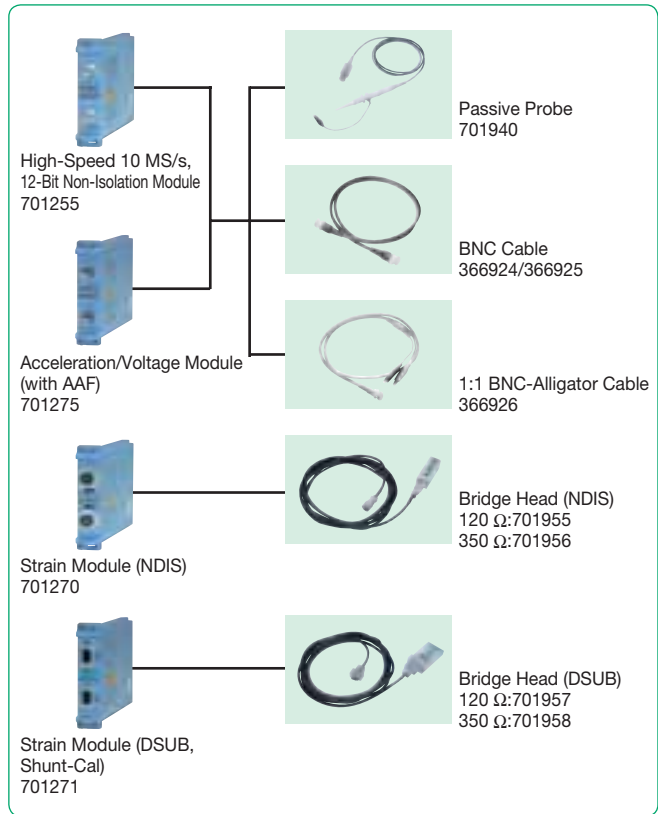
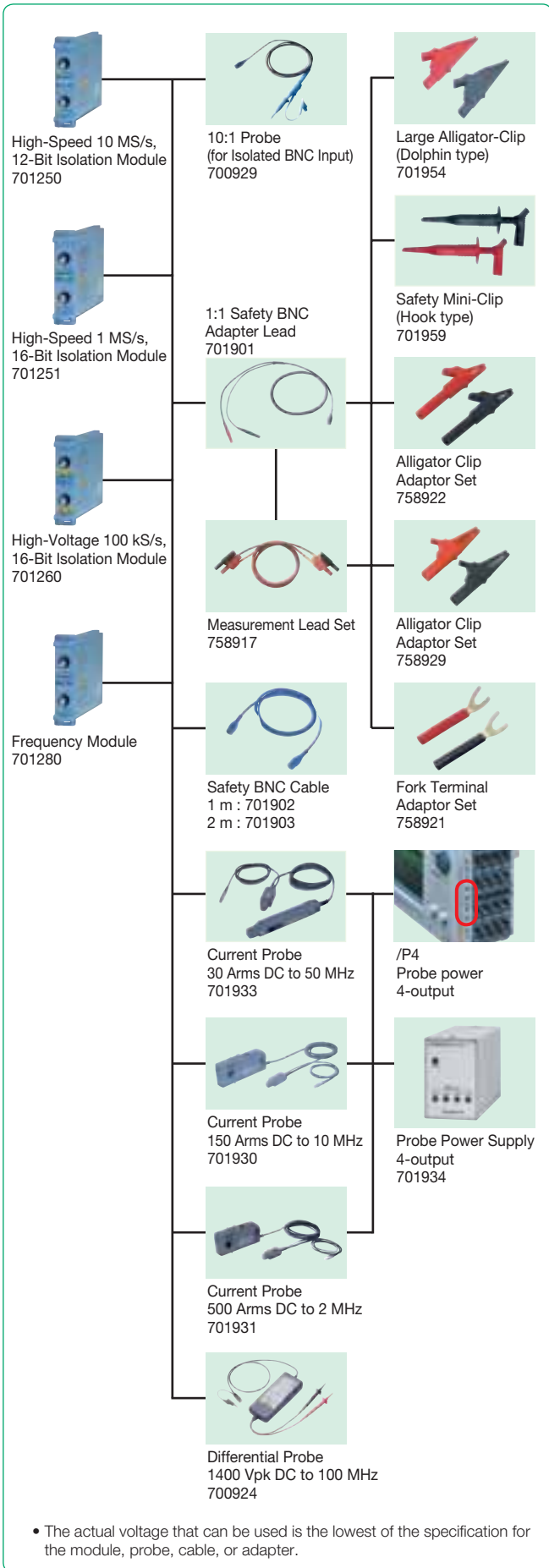

**Measurement Range and Display Range**

The measurement range of the ScopeCorder is ±10 divisions (20 divisions of absolute width (span)) around 0 V. The display range of the screen is ±5 divisions (10 divisions of span). The following functions can be used to move the displayed waveform and display the waveform outside the display range by expanding/reducing the displayed waveform.

- Move the vertical position.
- Set the offset voltage (DL750/DL750P).
- Zoom in or out of the vertical axis (expand/reduce).

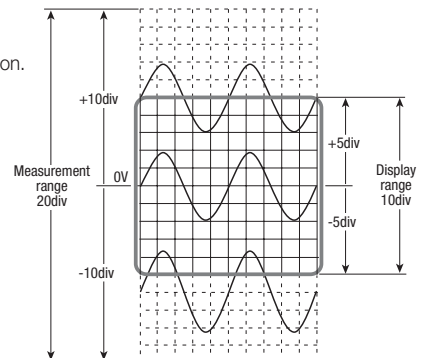

### Logic Probe Accessories and Carrying Case

**Logic signal input connector**

**Soft carrying case**  
701963 (for the DL750)  
701967 (for the DL750P/SL1400)

**Logic Probe (TTL level/Contact Input)**  
1m: 702911/3m: 702912  
\*Specific to the SL1400

**High-Speed Logic Probe**  
700986

**Isolation Logic Probe**  
700987

**Measurement Lead Set**  
758917

**Large Alligator-Clip (Dolphin type)**  
701954

**Safety Mini-Clip (Hook type)**  
701959

**Alligator Clip Adaptor Set**  
758922

**Alligator Clip Adaptor Set**  
758929

**Fork Terminal Adaptor Set**  
758921

### Maximum Input Voltage and Maximum Allowable Common Mode Voltage

#### See Specifications of Plug-in Modules

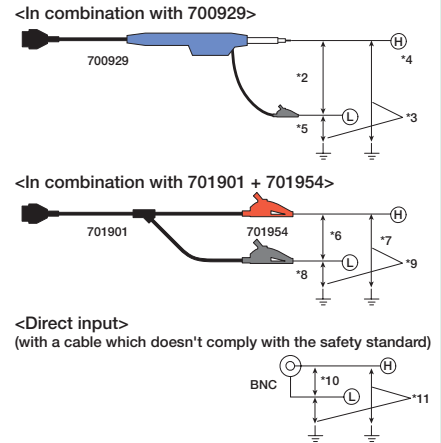

#### WARNING

Do not apply input voltage exceeding the maximum input voltage, withstand voltage, or allowable surge voltage. To prevent the possibility of electric shock, be sure to furnish protective earth grounding of the main unit. To prevent the possibility of electric shock, be sure to fasten the module screws. Otherwise, the electrical and mechanical protection functions will not be activated.

### Complete Connectivity

- Voice memo input/output (DL750/DL750P)**  
Earphone-Mic input/output  
Volume control for recording and playback
- GP-IB**
- A4 Size High Resolution Thermal Printer (DL750P/SL1400)**
- Ethernet (optional)**  
Supports 100BASE-TX and 10BASE-T
- Video Out (SVGA)**  
Outputs a video signal so waveform can be viewed on an external monitor
- SERIAL (RS232)**
- Logic input (8 bits x 2)**  
Logic Probe 700986/700987, or 702911/702912 (SL1400)
- External trigger input**
- Trigger output/external clock input (switch)**  
Outputs TTL level trigger signals.  
External clocks as fast as 1 MHz can be used.
- Internal hard drive (optional)**
- Drive (optional)**
  - Floppy disk drive (DL750/DL750P)
  - Zip drive (DL750)
  - PC card interface\*  
Flash ATA card  
Compact Flash  
Microdrive
- SCSI interface**
- USB-PC jack (complies with USB Rev.1.1)**
- USB peripheral jacks (complies with USB Rev.1.1)\***  
For use with a USB mouse/keyboard/printer/mass storage device
- GO/NO-GO input/output (DL750/DL750P)**  
External start/stop

\* Ask for information on compatible products.

### Exterior Dimensions

(Unit: mm)

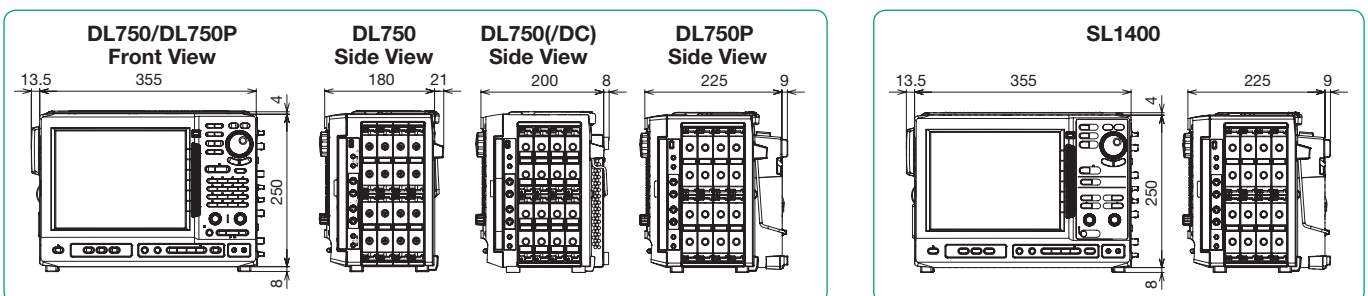

## DL750/DL750P ScopeCorder Model Numbers and Suffix Codes

Model/Options	Suffix Code	Description
701210		DL750 main unit (16 isolated channels, 8 slots + 16-bit logic)*1 112 mm width A6 thermal printer built-in
701230		DL750 main unit (16 isolated channels, 8 slots + 16-bit logic 112 mm width A4 thermal printer built-in)
Power code	-D	UL and CSA standard
	-F	VDE standard
	-R	AS standard
	-Q	BS standard
	-H	GB standard (Complied with CCC)
Built-in media drive*2	-J1	Floppy disk drive
	-J2	Zip drive (DL750 only)*3
	-J3	PC card interface
Default language	-HE	English
	-HJ	Japanese
	-HC	Chinese
	-HK	Korean
	-HG	German
	-HF	French
	-HL	Italian
	-HS	Spanish
Memory expansion	/M1	Memory expansion to 10 MW/ch*4 (250 MW max.)
	/M2	Memory expansion to 25 MW/ch*4 (500 MW max.)
	/M3	Memory expansion to 50 MW/ch*4 (1 GW max.)
Others	/C8	Internal 40 GB hard disk (FAT32)
	/C10	Ethernet interface
	/G2	User-defined computation
	/G3	DSP channel
	/P4	Four probe power outputs
	/DC	DC12 V power (10 to 18 VDC) (DL750 only)*3

\*1: Plug-in modules are not included.

\*2: Choose only one.

\*3: Zip drive and DC12 V power supply cannot be specified together with the DL750P.

\*4: Cannot be specified together.

## Plug-in Module Model Numbers

Model	Description
701250	High-speed 10 MS/s 12-Bit Isolation Module (2 ch)
701251	High-speed 1 MS/s 16-Bit Isolation Module (2 ch)
701255	High-speed 10 MS/s 12-Bit non-Isolation Module (2 ch)
701260	High-voltage 100 kS/s 16-Bit Isolation Module (with RMS, 2 ch)
701261	Universal Module (2 ch)
701262	Universal Module (with Anti-Aliasing Filter, 2 ch)
701265	Temperature/high-precision voltage Module (2 ch)
701270	Strain Module (NDIS, 2 ch)
701271	Strain Module (DSUB, Shunt-CAL, 2 ch)
701275	Acceleration/Voltage Module (with Anti-Aliasing Filter, 2 ch)
701280	Frequency Module (2 ch)

\* Probes are not included with any modules.

\* The pictures in description of functions are the photographs of DL750/DL750P.

 **ScopeCorder**  **GigaZ.com** are trademarks, pending trademarks or registered trademarks of Yokogawa Electric Corporation.

\* Any company's names and product names mentioned in this document are trade names, trademarks or registered trademarks of their respective companies.

# nbn

## ELEKTRONIK AG

Birmensdorferstrasse 30 Tel +41 (0)44 404 34 34  
CH-8142 Uitikon Fax +41 (0)44 493 50 32  
sales@nbn-elektronik.ch www.nbn-elektronik.ch

# YOKOGAWA

**YOKOGAWA ELECTRIC CORPORATION**

Communication & Measurement Business Headquarters /Phone: (81)-422-52-6768, Fax: (81)-422-52-6624

E-mail: tm@cs.jp.yokogawa.com

**YOKOGAWA CORPORATION OF AMERICA**

Phone: (1)-770-253-7000, Fax: (1)-770-251-6427

**YOKOGAWA EUROPE B.V.**

Phone: (31)-88-4641000, Fax: (31)-88-4641111

**YOKOGAWA ENGINEERING ASIA PTE. LTD.**

Phone: (65)-62419933, Fax: (65)-62412606

## SL1400 ScopeCorder LITE Model Numbers and Suffix Codes

Model/Options	Suffix Code	Description
701240		SL1400 main unit (16 isolated channels, 8 slots + 16-bit logic)*1 210 mm width A4 thermal printer built-in
Power code	-D	UL and CSA standard
	-F	VDE standard
	-R	AS standard
	-Q	BS standard
	-H	GB standard (Complied with CCC)
Built-in media drive*2	-J0	No built-in media drive
	-J3	PC card interface
Default language	-HE	English
	-HJ	Japanese
	-HC	Chinese
	-HK	Korean
	-HG	German
	-HF	French
	-HL	Italian
	-HS	Spanish
Others	/C8	Internal 40 GB hard disk (FAT32)
	/C10	Ethernet interface
	/P4	Four probe power outputs

\*1: Plug-in modules are not included. \*2: Choose only one.

## Probes, Cables, and Converters

Product	Model No.	Description*1
10:1 Probe (for Isolated BNC Input)	700929	1000 Vrms-CAT II
1:1 Safety BNC Adapter Lead (in combination with followings)	701901	1000 Vrms-CAT II
Safety Mini-Clip (Hook type)	701959	1000 Vrms-CAT II, 1 set each of red and black
Large Alligator-Clip (Dolphin type)	701954	1000 Vrms-CAT II, 1 set each of red and black
Alligator Clip Adaptor Set (Rated Voltage 1000 V)	758929	1000 Vrms-CAT II, 1 set each of red and black
Alligator Clip Adaptor Set (Rated Voltage 300 V)	758922	300 Vrms-CAT II, 1 set each of red and black
Fork Terminal Adapter Set	758321	1000 Vrms-CAT II, 1 set each of red and black
Passive Probe*2	701940	Non-isolated 600 Vpk (701255)(10:1)
1:1 BNC-Alligator Cable	366926	Non-isolated 42 V or less, 1m
1:1 Banana-Alligator Cable	366961	Non-isolated 42 V or less, 1.2m
Current Probe*3	701933	30 Arms, DC to 50 MHz, supports probe power
Current Probe*3	701930	150 Arms, DC to 10 MHz, supports probe power
Current Probe*3	709131	500 Arms, DC to 2 MHz, supports probe power
Probe Power Supply*4	701934	Large current output, external probe power supply (4 outputs)
Shunt Resistor	438920	250 Ω±0.1%
Shunt Resistor	438921	100 Ω±0.1%
Shunt Resistor	438922	10 Ω±0.1%
Differential Probe	700924	1400 Vpk, 1000 Vrms-CAT II
Bridge Head (NDIS, 120 Ω/350 Ω)	701955/56	With 5 m cable
Bridge Head (DSUB, Shunt-CAL, 120 Ω/350 Ω)	701957/58	With 5 m cable
Safety BNC-banana Adapter	758924	500 Vrms-CAT II
Printer Roll Paper	B9988AE	For DL750, 10 m x 10
Printer Roll Paper	701966	For DL750P and SL1400, A4 size (210 mm wide x 20 m), include 6 rolls
Logic Probe (for SL1400)*5	702911	8-Bit, 1 m, non-Isolated, TTL level/Contact Input
Logic Probe (for SL1400)*5	702912	8-Bit, 3 m, non-Isolated, TTL level/Contact Input
High-speed Logic Probe*5	700986	8-Bit, non-Isolated, response speed: 1 μs
Isolated Logic Probe	700987	8-Bit, each channel isolated
Measurement Lead Set	758917	Measurement leads (2 per set) Alligator-Clip is required separately.
Conversion Adaptor	366928	BNC (jack)-RCA (plug) conversion
Safety BNC-BNC Cable (1 m)	701902	1000 Vrms-CAT II (BNC-BNC)
Safety BNC-BNC Cable (2 m)	701903	1000 Vrms-CAT II (BNC-BNC)
GO/NO-GO Cable	366973	For GO/NO-GO I/O and start input
DC Power Supply Cable (Cigarette lighter plug type)	701971	For DL750 DC12 V power
DC Power Supply Cable (Alligator clip type)	701970	For DL750 DC 12 V power
Earphone Microphone with a PUSH switch	701951	For DL750/DL750P Voice memo
Speaker Cable	701952	For DL750/DL750P Voice memo
Soft Carrying Case	701963	For DL750
	701967	For DL750P and SL1400

\*1 Actual allowable voltage is the lower of the voltages specified for the main unit and cable.

\*2 42 V is safe when using the 701940 with an isolated type BNC input.

\*3 The number of current probes that can be powered from the main unit's power supply is limited. For details, please refer to [http://www.yokogawa.com/tm/pdf/bu/701933/tm-701933\\_01.pdf](http://www.yokogawa.com/tm/pdf/bu/701933/tm-701933_01.pdf)

\*4 Any number of externally powered probes can be used.

\*5 Includes one each of the B9879PX and B9879KX connection leads.

\*6 Additionally, 758917 and either the 758922 or 758929 are required for measurement.

Subject to change without notice.

[Ed : 03/b] Copyright ©2008

Printed in Japan, 904(KP)