

Preliminary

YOKOGAWA 

# signal plorer™

Mixed Signal Oscilloscope

## *DL9000 Series MSO Models*

**4ch** Analog  
+  
**32bit** Logic  
**16bit** Logic



**3-Year**  
Warranty

- High speed waveform acquisition and history memory
  - Advanced trigger functions
- Powerful dual-window waveform zoom, search, and analysis
  - Lightweight and compact



# High performance and compact Mixed Signal Oscilloscope with 4 analog channels and 16/32-bit logic input



**4ch Analog**  
+  
**32bit Logic**  
**16bit Logic**

## ● Simultaneous measurement and analysis of 4 analog channels + 16/32-bit logic

Analog: 500MHz/1GHz frequency bandwidth  
Logic: Maximum toggle frequency of 250 MHz  
Analog and Logic Sampling speed: up to 5 GS/s  
Memory length: 6.25 MW/ch

- High speed acquisition and quick response
- Fast and powerful analysis of logic channels
- Capture and separate anomalies easily with History Memory
- Extensive trigger functions for handling the most complex waveforms
- Versatile zoom and search functions
- Lightweight and compact

Outer dimensions:

Approximately 350 (W)×200 (H)×285 (D) mm

Weight: Approximately 8 kg

Model	DL9710L	DL9705L	DL9510L	DL9505L
Analog inputs channels	4ch			
Analog Frequency Bandwidth	1GHz	500MHz	1GHz	500MHz
Logic inputs channels	32bits		16bits	
Max. Logic toggle frequency	250MHz			
Max. Sampling Speed	5GS(Simultaneous sampling of analog and logic)			

## ■ 4ch Analog & 32/16 bit Logic Signal Analysis

Debugging mixed signal circuits requires an expanded set of capabilities beyond what a general oscilloscope or logic analyzer can offer alone. The DL9000 series MSO models offer convenient, innovative functions for display and analysis of mixed signal characteristics.

State display and bus display functions are typically found in logic analyzers. DL9000 series MSO models support these types of logic signal display and analysis functions and help increase efficiency in the coordinated analysis of analog and logic signals. Moreover, when performing these analysis and display functions on DL9000 series MSO models, the screen display update rate is not compromised.

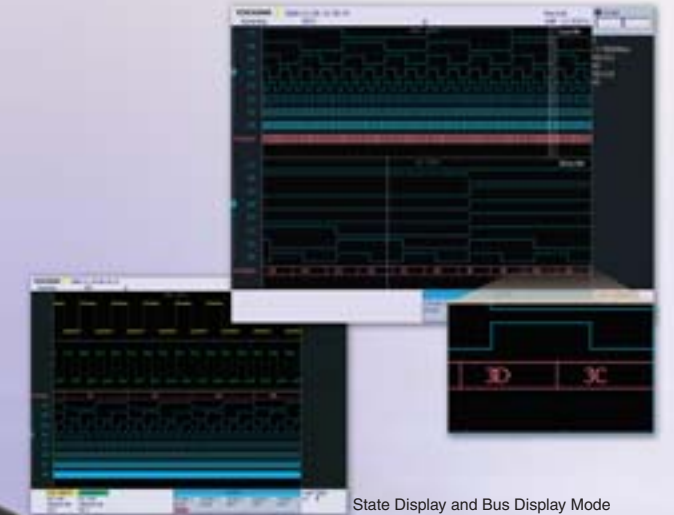
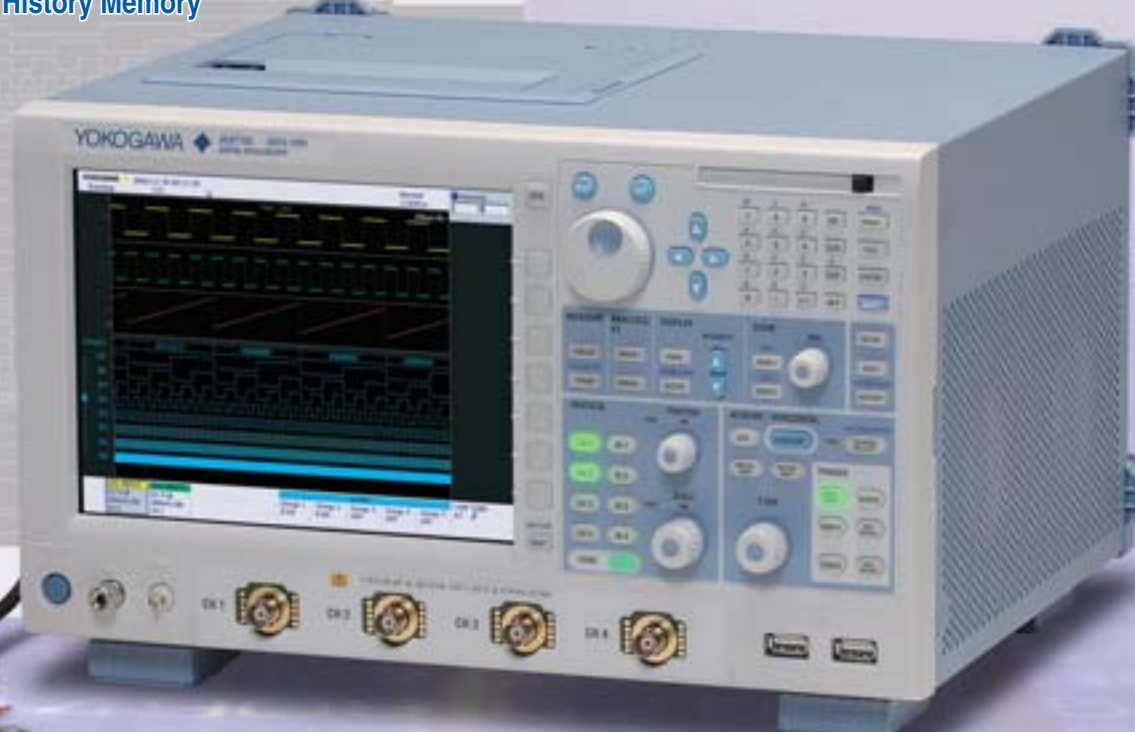

State Display and Bus Display Mode

## ■ High Speed Response

**High-Speed Display and Updating at up to 2.5 Million waveforms/s and Megawords of Data from 4 Analog + 16/32-bit Logic Inputs with the least compromise**

You need a fast waveform update rate to maximize your chance of catching that infrequent waveform variation. You also need an oscilloscope that doesn't become sluggish and unresponsive with processor intensive functions or deep memory enabled. Yokogawa's Advanced Data Stream Engine (ADSE) is unmatched in this area. Logic channel inputs, and even bus display mode, won't affect the update rate, giving you the best possible real time display and analysis of mixed signal waveforms.

Maximum update rate:

2,500,000 waveforms/sec (2.5kW, N Single Trigger Mode)

25,000 waveforms/sec (2.5kW, Normal Trigger Mode)

Maximum update rate in math mode:

60 waveforms/sec (1 MW, when performing channel addition)

12 waveforms/sec (5 MW, when performing channel addition)

Maximum update rate in parameter measurement mode:

60 waveforms/sec (1 MW, when measuring a channel's maximum value)

16 waveforms/sec (5 MW, when measuring a channel's maximum value)

Note: The above rates can vary depending on the oscilloscope settings



Advanced Data Stream Engine (ADSE)

## ■ History Memory Function

Other oscilloscopes show you digitally persisted acquisitions in just one display layer. What if there is a signal buried within the "fuzz" you would like to separate?

**With the DL9000, not only can you toggle digital persistence (accumulation) on or off, Yokogawa's unique "history memory" also allows you to separate and view previously acquired data individually.**

DL9000 series MSO models not only update the display at high speed, but also include a function for recalling up to 2000 screens worth of past waveforms. High-speed screen updating alone does not allow users to take full advantage of the digital oscilloscope. Rather, the ability to redisplay and analyze individual waveforms unleashes the digital oscilloscope's full potential.





## Waveform Acquisition —Numerous Triggers—

With DL9000 MSO models, you not only have access to the existing DL9000 series of powerful trigger functions, but you can also set trigger conditions using a logic signal as the source. You can restrict capture to the desired signals by combining various trigger conditions, thus reducing evaluation times and speeding up troubleshooting.

### DL9000 Series MSO models' Trigger Functions

Edge/state triggers	Pulse width triggers	Enhanced triggers	Event interval triggers
<ul style="list-style-type: none"> <li>Edge</li> <li>Edge (Qualified: conditional)</li> <li>Edge OR</li> <li>State</li> <li>Logic Edge</li> <li>Logic Edge (Qualified: Conditional)</li> <li>Logic State</li> </ul>	<ul style="list-style-type: none"> <li>Pulse width</li> <li>Pulse width (Qualified)</li> <li>Pulse state (Triggered using the length of period during which the conditions are true)</li> <li>Logic Pulse width</li> <li>Logic Pulse state (Triggered using the length of period during which the conditions are true)</li> </ul>	<ul style="list-style-type: none"> <li>TV (NTSC/PAL (SECAM)/HDTV)</li> <li>I<sup>2</sup>C</li> <li>SPI</li> <li>CAN/LIN</li> <li>Serial pattern (define patterns up to 128 bits long)</li> </ul>	<ul style="list-style-type: none"> <li>Event cycle</li> <li>Event delay</li> <li>Event sequence</li> </ul>

### Examples of Trigger Application

**Trigger-based gating – Edge (Qualified): conditional trigger –**  
The valid/invalid state of an edge trigger or pulse width trigger can be controlled according to the conditions of any other channel's state (high/low).

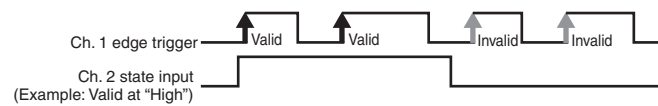

**Setup time trigger / Hold time trigger**  
To derive setup time/hold time conditions, event delay/event sequence triggers are set as shown in the following figure.

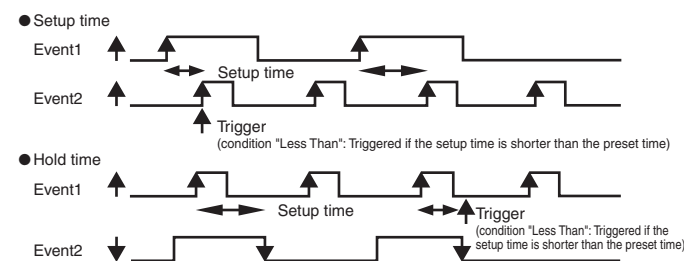

## Waveform Display —Groups and Mapping—

DL9000 MSO models allow you to assign 32-bit logic signals to up to five groups. There is no limit to the number of bits allowed in each group. For example, you can assign all 32bits to a single group. Groups are assigned using a graphical interface for flexible and easy settings. For example, even in cases such as where a reconfigurable device's pin assignments have been changed, you can make the corresponding adjustments simply by changing the mapping of the groups. Analysis such as bus display, state display, and DA conversion can be executed on a group-by-group basis.

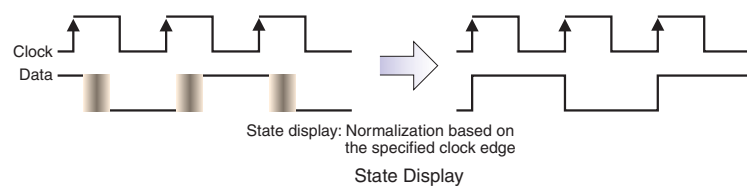
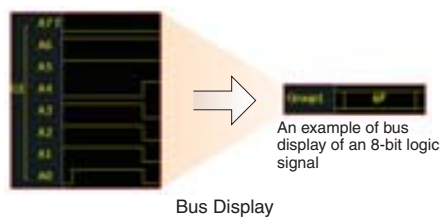
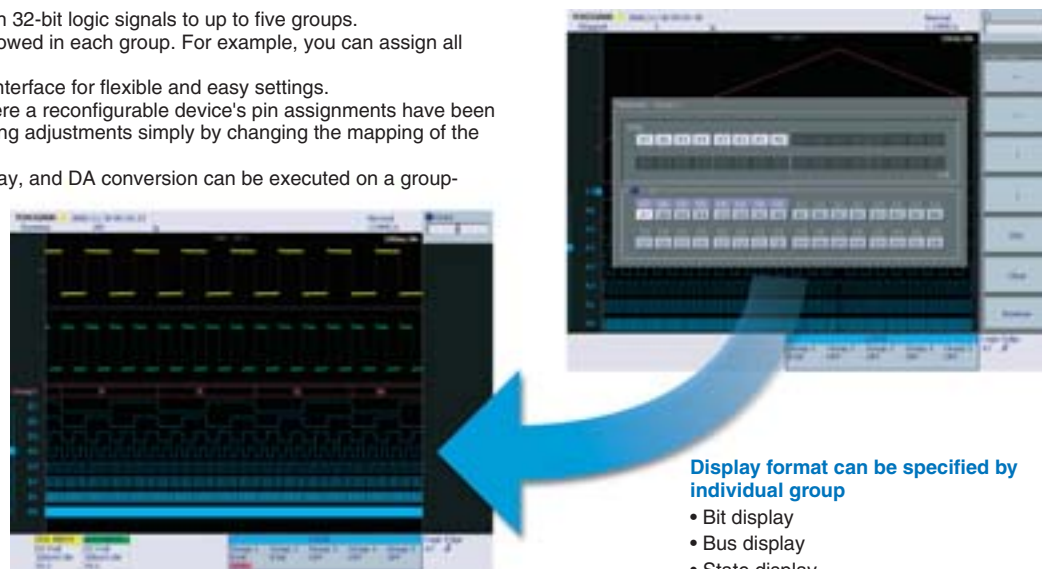

## Search & Zoom

Even if waveforms are displayed at high speed and held in the oscilloscope's acquisition memory, it does not help if it then takes time for the user to find the desired phenomena. Functions for searching and zooming acquired waveform data are key to increasing engineering efficiency. DL9000 MSO models include powerful functions for searching the memory for desired waveforms, and zoom functions for observing these waveforms in detail. In addition to searching based on criteria such as signal edge, pulse, and multichannel state, you can search the history memory by waveform patterns and waveform parameters. You can quickly find the desired waveform data in the memory, enlarge the area with the zoom function, and scroll the data. These processes are carried out by the hardware at high speeds, eliminating wasteful wait times after operating the oscilloscope.

### Dual-window Zoom function simultaneously zooms in on two areas

Two individual zoom factors and positions can be set with independent timescales and displayed simultaneously. Also, using the auto scroll function, you can automatically scroll waveforms captured in long memory and change the position of the zoom areas. Choose any display position with forward, backward, fast-forward, pause, and other controls.

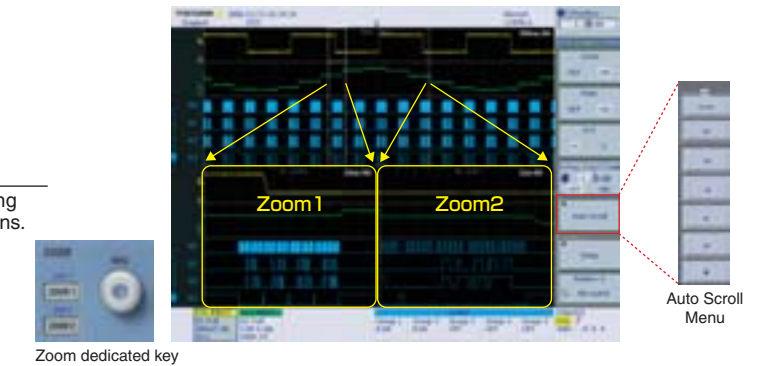

### A variety of search functions

DL9000 MSO models have a variety of waveform search functions, enabling you to detect abnormal signals or find specific serial or parallel data patterns. Data search types include:

- State search (based on high/low states of one or more channels)
- Serial pattern search (I<sup>2</sup>C/SPI/CAN/general-purpose pattern)
- Zone search
- Waveform window search
- Waveform parameter search (measured parameters, FFT, etc.)

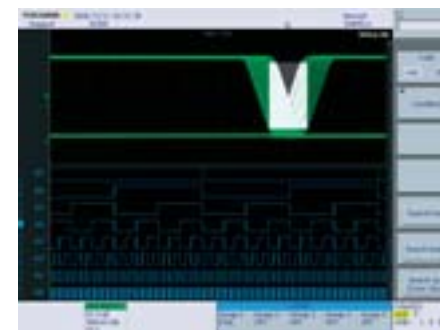

**Zone search in History Memory**  
Define 1 to 4 zones and search for waveforms that fall inside or outside the zone (s).



**Waveform parameter search**  
Select a waveform parameter and define a range for the parameter. Search for waveforms with parameter values inside or outside the set range.



**Search for serial pattern**

### Also enables searching of logic signal waveforms

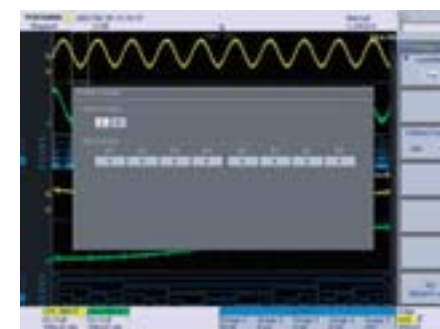

**Bus values**  
You can search by logic signal bus values.

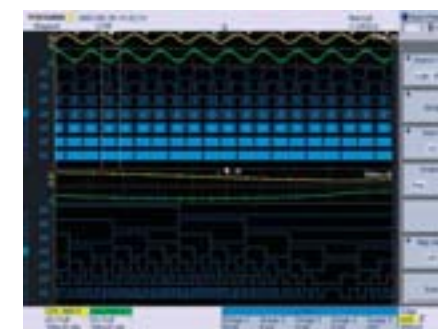

**Pulse width**  
Search by specifying pulse width conditions.



**Serial bus**  
Search for portions of analysis results of the logic signal's source serial bus that match specified conditions.



## Waveform Analysis —Serial Bus Analysis (I<sup>2</sup>C, SPI, CAN\*, LIN\*)—

The DL9700/9500 can perform I<sup>2</sup>C, SPI, LIN and CAN bus analysis with the different available options (/F5, /F7 and /F8). Triggers for these bus types are standard features. These functions make it easy to discriminate between partial software failures and physical-layer waveform problems when troubleshooting systems by observing the physical-layer characteristics of signals. Also, I<sup>2</sup>C, SPI and LIN bus analysis of logic signals are available, allowing you to simultaneously perform protocol analysis of the various buses using logic input channels, and signal analysis using 4 analog channels.

### Serial data bus trigger functions

A wide range of trigger conditions can be set, including triggers based on ID-Data combinations and combinations of a serial bus trigger and a regular edge trigger.

### Real-time bus analysis-up to 15 updates/sec

The DL9000 displays protocol analysis results while bus signals are being captured.

### Simultaneous analysis of different buses

With the Dual-window Zoom function, the DL9000 can simultaneously analyze and display the waveform of buses running at different speeds.

### Decode Display

Analysis results of analog input channels can be displayed not only in a list, but also shown as a decode next to the waveform.

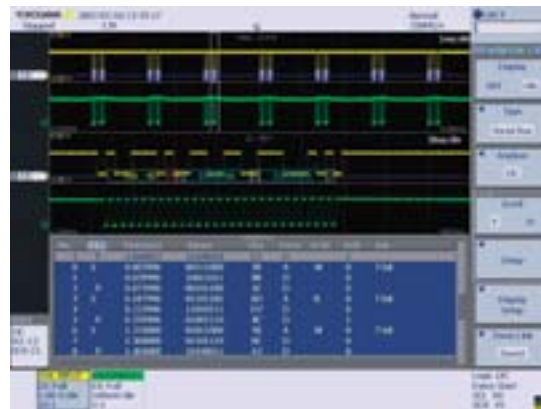

Example of I<sup>2</sup>C Bus Analysis Display



Example of simultaneous analysis and waveform (decode) display of CAN and LIN bus signals

\*CAN trigger and CAN analysis is supported by the analog input channels.

## Logic Waveform Analysis —“Virtual D/A” Function—

Digital to Analog conversion of logic signals can be performed on a group-by-group basis. This is an invaluable tool for evaluating A/D and D/A converters along with their surrounding circuits. For even faster debugging, use it together with waveform analysis functions such as the histogram function. Even evaluations normally requiring computation programs on the PC can be executed quickly and easily using the powerful computation built-in functions of DL9000 MSO models.

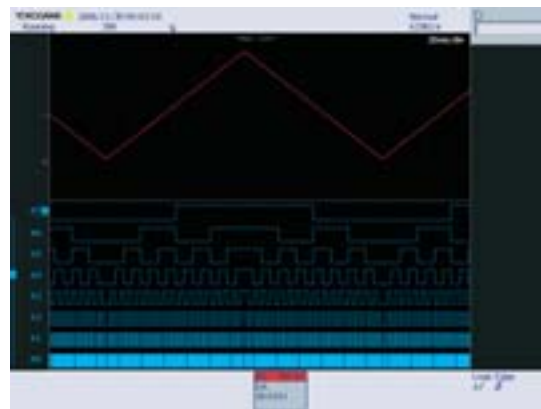

Logic waveform and DA conversion waveform

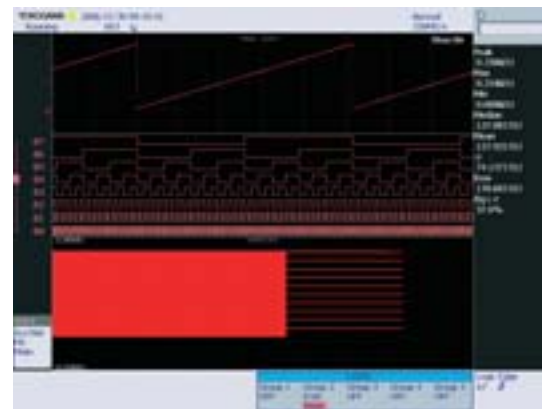

DA conversion waveform and Histogram analysis

## Automated measurement of waveform parameters



You can automatically measure waveform parameters, including max., min., peak-peak, pulse width, period, frequency, rise time, fall time, and duty ratio.



Time domain waveform parameters such as pulse width, interval, and delay can be measured automatically for logic signals as well.

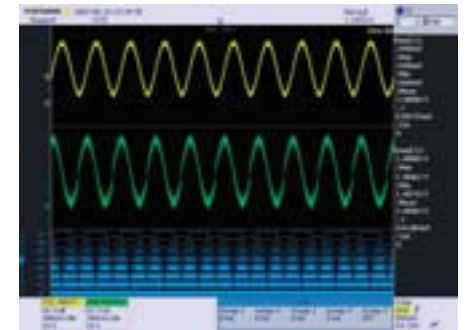

Waveform parameters can be calculated repeatedly every screen or period, and the statistical results (mean, maximum, minimum, standard deviation, etc.) of the waveform parameters can be displayed. Automated measurement of waveform parameters and statistical computations can also be performed on waveform data in history memory.

## Analysis functions for specialized applications

### Eye Pattern Analysis and Mask Testing

#### ◆ Eye Pattern Analysis

This function automatically measures the waveform parameters of an eye pattern. Unlike the waveform parameter measurement of earlier DL series oscilloscopes, DL9000 MSO models can calculate parameters based on the eye pattern formed by the crossings of two or more waveforms.

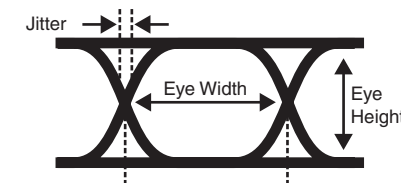

#### ◆ Mask Testing

This function is used to evaluate the signal quality of high-speed data communication. Using Mask Editor software, a mask pattern is generated and loaded into DL9000 MSO models. (The Mask Editor software can be downloaded from Yokogawa Electric's web page.)

① Mask pattern generation using the Mask Editor software

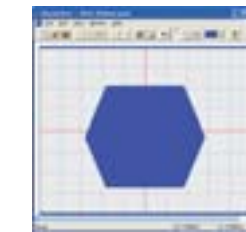

② After loading the mask pattern to DL9000 MSO models Series, you can perform error rate analysis or go/no-go judgment.

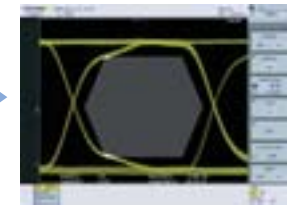

### Power Supply Analysis (Optional)

Effective power supply analysis can be easily carried out using the waveform computation, statistical computation and automatic parameter measurement functions. Harmonic analysis of power supply currents based on EN61000-3-2 is also supported.

#### [Main Functions]

- Measurement and statistical computation of parameters specific to power supply analysis such as electric energy and power factor
- Measurement of switching loss with history statistics
- Computation functions required for power supply analysis such as active power, impedance, and Joule-integral
- Harmonic analysis of power supply current based on EN61000-3-2

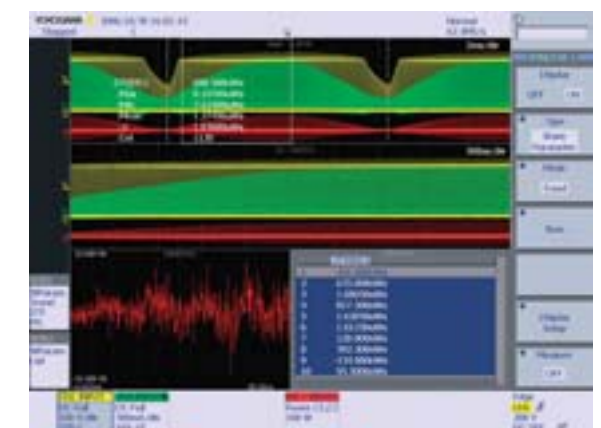



## Accessory software

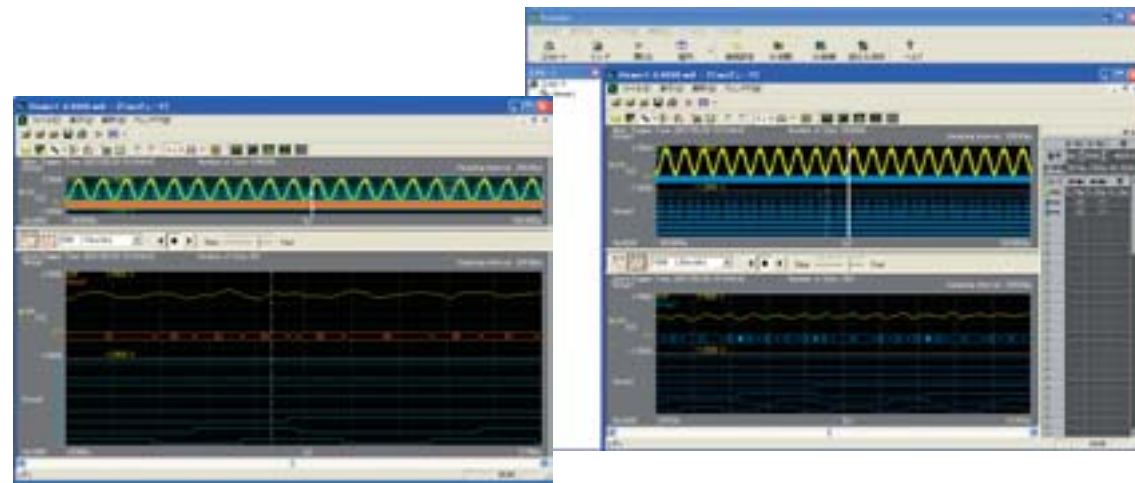

### Xviewer (701992, sold separately)

This PC software program displays and analyzes analog and logic waveforms captured by a DL series instrument (including DL9000 MSO models). It supports measurement of waveform parameters, FFT and user-defined computation functions, logic signal bus display, DA conversion and display, and other functions. Because you can place analog and logic waveforms anywhere on the screen, you can superimpose these waveforms, or display logic signals in three different formats (waveform, bus, and DA) at the same time. Additionally, zoom and scroll functions are easy to use and help you to perform analysis of mixed analog and digital signals from a variety of approaches. Also featuring functions for control of DL9000 MSO models via USB or Ethernet, Xviewer is a high cost-performance, integrated waveform analysis tool offering oscilloscope control, measurement, data transfer, waveform observation, and analysis.



Control DL9000 MSO models via USB or Ethernet. Provides simple control and transfer of waveform data to a PC through an intuitive man-machine interface.

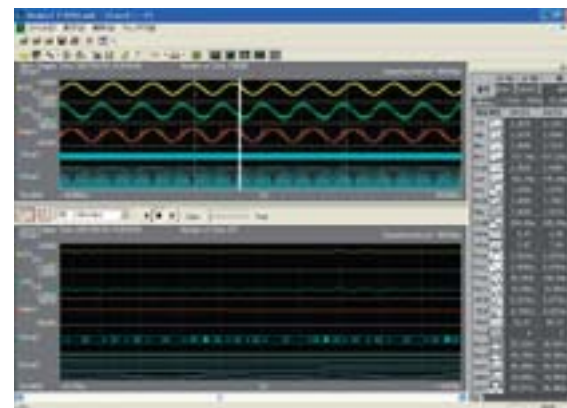

Logic signals can be rendered on screen in a waveform, bus, or DA display, and can also be displayed for comparisons with analog waveforms. You can freely define on-screen display methods to match your objectives and ensure easy-to-see, easy-to-evaluate display of multichannel signals.

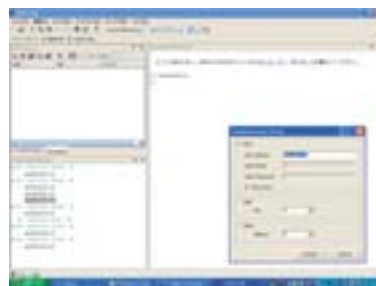

### MATLAB Control Tool Kit (Optional software)

With the MATLAB tool kit, you can easily deal with waveform data captured using the DL series oscilloscope in a MATLAB environment. The software can be used to control the DL series' panel settings or to transfer data from the DL series to MATLAB.



### DL Series Library (freeware)

This API lets you control the DL9000 series from an external program or to transfer the DL9000 series' data to the external program. The API is available as a Windows DLL and can be accessed from your program.

## Versatile Connectivity

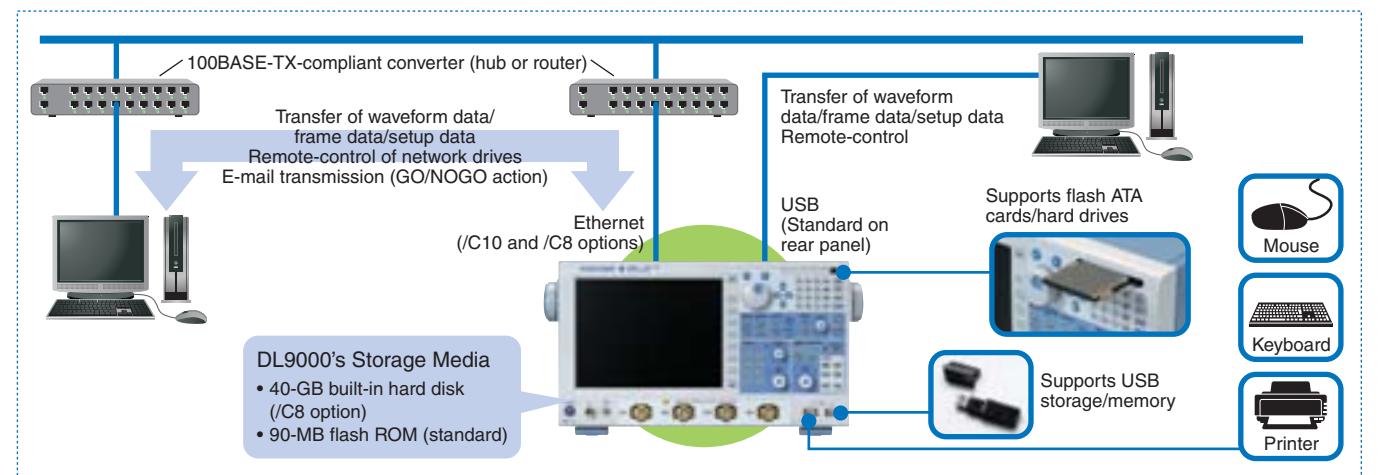
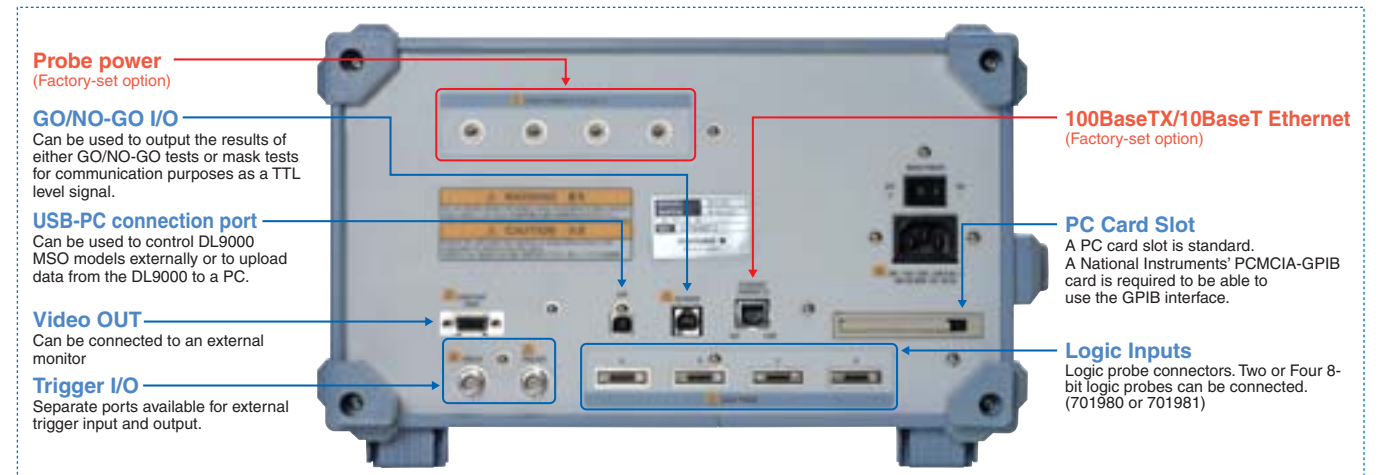

## Main Specification

Models				
Model name(No.)	Freq. BW	Max. sampling rate	Logic input	Max. record length
DL9505L(701320)	500MHz	5GS/s	16ch	6.25MW
DL9510L(701321)	1GHz	5GS/s	16ch	6.25MW
DL9705L(701330)	500MHz	5GS/s	32ch	6.25MW
DL9710L(701331)	1GHz	5GS/s	32ch	6.25MW

Basic Specifications	
<b>Analog Inputs</b>	
Input channels:	4 (CH1 to CH4)
Input coupling:	AC, DC, GND, DC50Ω
Input impedance:	1 MΩ±1.0% approx. 20 pF 50 Ω±1.5%
Voltage axis sensitivity:	For 1 MΩ input : 2 mV/div to 5 V/div (steps of 1-2-5) For 50 Ω input : 2 mV/div to 500 mV/div (steps of 1-2-5)
Maximum input voltage:	For 1 MΩ input : 150 Vrms CAT I (when frequency is under 1 kHz) For 50 Ω input : 5 Vrms or less and 10 Vpeak or less
Vertical (voltage) axis sensitivity:	
DC accuracy*1:	For 1 MΩ input : ±(1.5% of 8 div + offset voltage accuracy) For 50 Ω input : ±(1.5% of 8 div + offset voltage accuracy)
Offset voltage axis accuracy*1:	2 mV/div to 50 mV/div : ±(1% of setting + 0.2 mV) 100 mV/div to 500 mV/div : ±(1% of setting + 2 mV) 1 V/div to 5 V/div : ±(1% of setting + 20 mV)
Frequency characteristics*1,2 (Attenuation point of -3 dB when inputting a sine wave of amplitude ±2 div or equivalent)	
For 50 Ω input	DL9505L/DL9705L DL9510L/DL9710L
0.5 V/div to 10 mV/div:	DC to 500MHz DC to 1 GHz
5 mV/div:	DC to 400MHz DC to 750 MHz
2 mV/div:	DC to 400MHz DC to 600 MHz

A/D conversion resolution:	For 1 MΩ input (from the probe tip when using the PB500 dedicated passive probe)	5 V/div to 10 mV/div: DC to 500MHz	DC to 500 MHz
	5 mV/div to 2 mV/div:	DC to 400MHz	DC to 400 MHz
Bandwidth limit:	8-bit (25 LSB/div)	For each channel, select from FULL, 200 MHz, 20 MHz, 8 MHz, 4 MHz, 2 MHz, 1 MHz, 500 kHz, 250 kHz, 125 kHz, 62.5 kHz, 32 kHz, 16 kHz, and 8 kHz (separately configurable on each of channels CH1 to CH4); Limit implemented with analog (200 MHz, 20 MHz) and digital filters (IIR+ FIR).	
Max. sampling rate:	Real time sampling mode:	Interleave mode ON: 5 GS/s Interleave mode OFF: 2.5 GS/s	
	Repetitive sampling mode:	2.5 TS/s	
Maximum record length:	6.25 MW		
Time axis setting range:	500 ps/div to 50 s/div (steps of 1-2-5)		
Time base accuracy*1:	±0.001%		
Max. acquisition rate*3:	When using 1.25 MW, 60 waveforms/sec/ch When using 12.5 kW, 9000 waveforms/sec/ch When using 2.5 kW, 25000 waveforms/sec/ch		
	Min. dead time (N single)*2: 400 ns or less (equivalent to 2.5 M waveforms/sec)		
<b>Logic Inputs</b>			
Number of inputs:	DL9505L /9510L	16bits (using two logic probes)	
	DL9705L/9710L	32 bits (using four logic probes)	
Logic probe:	Type 701980 or 701981	8bits each	
Maximum toggle frequency:	250 MHz (701981), 100 MHz (701980)		
Maximum input voltage:	±40V(DC + AC peak) or 28Vrms(When frequency is under 1 kHz)		
Minimum input voltage:	500 mVp-p		
Input voltage range:	±10 V (DC + AC peak, 701981), ±40 V (DC + AC peak, 701980)		



Logic Threshold level: ±10 V (0.1 V setting resolution, 701981)  
 ±40 V (0.1 V setting resolution, 701980)  
 Input impedance: approx. 10kΩ/approx. 9 pF (701981)  
 approx. 1MΩ/approx. 10 pF (701980)  
 Max. sampling rate: Interleave mode ON: 5 GS/s  
 nterleave mode OFF: 2.5 GS/s  
 Maximum record length: 6.25 MW

### Trigger Section

Trigger modes: Auto, Auto Level, Normal, Single, and N Single  
 Trigger source: DL9505L/DL9510L: CH1 to CH4, LINE, EXT and LOGIC 16bits  
 DL9705L/DL9710L: CH1 to CH4, LINE, EXT and LOGIC 32bits

Trigger types:  
 Edge/State  
 Edge: Trigger occurs on the edge of a single trigger source.  
 Edge (Qualified): Trigger occurs on the edge of a single trigger source when Qualification condition is true.  
 Edge OR: Trigger occurs on the OR logic of the edge conditions set to multiple trigger sources (Max. 50 MHz).  
 State: Trigger occurs on ENTER/EXIT when the state condition is true.  
 Logic Edge: Trigger occurs on the edge of a single trigger source for each Pod (PodA to PodD of DL9705L/9710L, PodA and PodC of DL9505L/DL9510L)  
 Logic Edge (Qualified): Trigger occurs on the edge of a single trigger source when Qualification condition is true for each Pod (PodA to PodD of DL9705L/9710L, PodA and PodC of DL9505L/DL9510L)  
 Logic State: Trigger occurs on ENTER/EXIT when the state condition is true for each Pod (PodA to PodD of DL9705L/9710L, PodA and PodC of DL9505L/DL9510L)  
 Width  
 Pulse: Trigger occurs on a width of a single trigger source.  
 Pulse (Qualified): Trigger occurs on a width of a single trigger source when Qualification condition is true  
 Pulse State: Trigger occurs on a width when the state condition is true.  
 Logic Pulse: Trigger occurs on a width of a single trigger source for each Pod (PodA to PodD of DL9705L/9710L, PodA and PodC of DL9505L/DL9510L)  
 Logic Pulse State: Trigger occurs on a width when the state condition is true for each Pod (PodA to PodD of DL9705L/9710L, PodA and PodC of DL9505L/DL9510L)  
 Time width setting mode: More than, Less than, Between, Out of Range, Time out  
 Specified time (T1/T2): 1 ns to 10 s, 500 ps resolution  
 Time accuracy: ±(0.2% of setting + 1 ns)

Event Interval  
 Event Cycle: Trigger occurs when the event cycle is within the specified time range.  
 Event Delay: After Event 1 occurs, trigger occurs on 1st occurrence of Event 2 that satisfies the timing constraints. The trigger process is reset if Event 1 or Event 2 occurs before the timing constraints are satisfied.  
 Event Sequence: After Event 1 occurs, trigger occurs on 1st occurrence of Event 2 that satisfies the timing constraints. The trigger process is not reset if Event 1 occurs before the timing constraints are satisfied.  
 Time width setting mode: Function identical to the time width setting mode for Width  
 Event Cycle: Specified time (T1/T2): 1.5 ns to 10 s, 500 ps resolution  
 Time accuracy: ±(0.2% of setting + 1 ns)  
 Event Delay and Event Sequence:  
 After Event 1 occurs, trigger occurs on 1st occurrence of Event 2 that satisfies the timing constraints. The trigger process is reset if Event 1 or Event 2 occurs before the timing constraints are satisfied.  
 When trigger source on Event 1 and Event 2 is selected from CH1 to CH4 or when both trigger sources on Event 1 and Event 2 are selected from Logic input bits.  
 Specified time (T1/T2): 1.5 ns to 10 s, 500 ps resolution  
 Time accuracy: ±(0.2% of setting + 1 ns)  
 When trigger source on Event 1 is selected from CH1 to CH4 and trigger source on Event 2 is selected from Logic input bits, or when trigger source on Event 1 is selected from Logic input bits and trigger source on Event 2 is selected from CH1 to CH4.  
 Specified time (T1/T2): 20 ns to 10s, 500ps resolution  
 Time accuracy: ±(0.2% of setting + 1 ns)  
 Event types: Events can be selected from Edge, Edge Qualified, State, Logic Edge, Logic Edge (Qualified), Pulse, Pulse Qualified, Pulse State, Logic Pulse, Logic Pulse State, PC, CAN, SPI, and Serial pattern, LIN (Selectable as event except for TV, Edge OR)

Enhanced  
 TV: Trigger occurs on video signals of various broadcasting system formats  
 Mode: NTSC, PAL, HDTV, USER  
 Trigger source: CH1-CH4  
 I<sup>2</sup>C: Triggers on I<sup>2</sup>C bus signals  
 Mode: NON ACK, Every Start, General Call, Start byte, HS Mode, ADR&DATA  
 SPI: Triggers on SPI (serial peripheral interface) bus signals  
 Mode: 3 wire, 4 wire  
 Trigger source: CH1-CH4, Logic input bits  
 CAN, LIN: CAN, LIN bus signals:  
 Trigger source: CAN: CH1 to CH4: Input through differential probe  
 LIN: CH1 to CH4, Logic input bits

Trigger types: CAN: SOF, Frame ID, Data field, Remote Frame, Error Frame, Ack, ID, Data OR, Data OR, Event Internal Synch Break, Event Interval  
 LIN: Synch Break, Event Interval  
 Bit rate: CAN: 1 Mbps, 500 kbps, 250 kbps, 125 kbps, 83.3 kbps, 33.3 kbps  
 User (freely settable in 100bps increments)  
 LIN: 19.2 kbps, 9.6 kbps, 4.8 kbps, 2.4 kbps, 1.2 kbps  
 Serial Pattern: Triggers on general-purpose serial communication signals.  
 Max. bit rate: 50 Mbps  
 Max. bit length: 128 bits

### Display

Display: 8.4-inch (21.3cm) color TFT liquid crystal display  
 Total number of pixels: 1024 X768 (XGA)  
 Waveform display resolution: 800 X 640

### Functions

Waveform Acquisition/Display Functions:  
 Acquisition modes: Selectable from three acquisition modes – Normal, Average and Envelope  
 Other acquisition functions: High resolution mode, Repetitive sampling mode, Interpolate function, Roll mode  
 Display Format: The display can be split to the following ways for analog waveform. Single (no split), Dual (two ways), Triad (three ways), Quad (four ways)  
 Analog waveform area and logic waveform area are split to two windows (Split ratio is selectable from 1:3, 1:1 or 3:1).  
 Bundle display of logic waveform area, State display  
 Accumulation: Accumulates waveforms on the display  
 Snapshot: Retains the current displayed waveform on the screen.

### Analysis Functions

Search and Zoom function: Zooms the displayed waveform along the time (Horizontal Zoom) and voltage (Vertical Zoom) axes. Independent zooming factors can be applied to two zoom areas.  
 Auto scroll function: Automatically scrolls the zoom window along the time axis  
 Search function: Searches the currently displayed waveform for a specified portion occurring beyond a specified time, and displays the zoomed result on the screen.  
 Search types: Edge, Edge (Qualified), State, Pulse, Pulse (Qualified), Pulse, State, Serial Pattern, Logic Edge, Logic Edge Qualified, Logic Width, Logic State, PC (optional), SPI (optional), CAN (optional), LIN (optional)

History memory:  
 Max data: 2000 (2.5 kW), when using history  
 1600 (2.5 kW), when in N single mode  
 History search: Searches for and displays waveforms from the history memory that meet specified conditions.

Search types: Rect, Wave, Polygon, Parameter (Measure/FFT/XY)  
 Replay: Automatically replays history waveforms.  
 Display: Selected acquisition (#) or Average (Avg.)  
 Cursor measurements: Vertical, Horizontal, H&V, VT, Marker, Serial  
 Automatic measurement of waveform parameters: MAX, MIN, HIGH, LOW, P-P, HIGH-LOW, +OVER, -OVER, RMS, MEAN, Sdev, IntegTY, C.rms, C.mean, C.Sdev, C.IntegTY, 1/FREQ, FREQ, COUNT, BURST, +WIDTH, -WIDTH, PERIOD, DUTY, RISE, FALL, DELAY  
 Items related to power supply analysis (optional).  
 Umn, Urmn, S, P, Q, Z, λ, Wp, Wp+, Abs.Wp, Up-p(P-P), U+pk(Max), U-pk(Min), Udc(C.Mean), Urms(C.Rms), Uac(C.Sdev), Imn, Irmn, q, q+, q-, Ads.q, Ft, Ip-p(P-P), I+pk(Max), I-pk(Min), Idc(C.Mean), Irms(C.Rms), Iac(C.Sdev)

Telecom test:  
 Mask test items: Wave Count, Wave Count%, Sample Point Count, Sample Point Count%  
 Eye pattern items: Vtop, Vbase\_top, \_base, Tcrossing1, Tcrossing2, Vcrossing, Crossing%, Eye Height, Eye Width, Q Factor, Jitter, Duty Cycle, Distortion%, Ext Rate dB, Rise, Fall

Computation functions: Computes up to eight traces (CH1-CH4/M1-M4) +, -, x, INTEG, COUNT (EDGE), COUNT (ROTARY), Through, Delay, Moving Avg, Low Pass, High Pass, Stuff Bit (CAN option), DA computation, User Define (optional), Power/Z/I<sup>2</sup>t (optional)  
 Reference functions: Display and analysis (computation and cursors) of up to four traces (M1-M4) of the saved waveform data.  
 Waveforms including history can also be loaded for history searches or replay.

Action-on-trigger: Automatically measured waveform parameters and waveform zones are determined, and the selected action is carried out each time conditions are met.

Modes: OFF, All Condition, (GO/NOGO Zone/Param), (GO/NOGO Telecom Test)  
 Actions: Buzzer, Print, Save, Mail  
 ANALYSIS: Selectable from XY, FFT, Wave Parameter, Accum Histogram and Serial Bus

### PC Bus Analysis Functions (optional)

Applicable bus : I<sup>2</sup>C bus: Bus speed : Max. 3.4 Mbit/s  
 Address mode : 7 bit/10 bit  
 SM bus: complies with System Management bus

Trigger function (standard): Source: SCL: CH1 to CH4, Logic input bits  
 SDA: CH1 to CH4, Logic input bits  
 Type: Selectable from the following five options:  
 Address & data, Non-Ack, Every start, General call, Start byte / HS mode

Analysis function:  
 Signal input: CH1 to CH4, Logic input bits, M1 to M4 can be configured  
 Simple display mode: Data (hex representation), R/W, start condition, presence/absence of ACK, address or data  
 Detailed data display mode: Time from the reference point, data (simultaneous binary and hex representations), presence/absence of ACK, R/W, address or data, start condition

Analyzable number of data items: 40,000 bytes max.  
 Search function:  
 Pattern search: Searches data that agrees with the preset address pattern, data pattern and acknowledge bit condition.

Analysis result save function:  
 Storage of analysis list data: The data can be saved to CSV-format files.

### SPI Bus Analysis Functions (optional)

Trigger function:(Standard)  
 Mode: 3 wire/4 wire  
 Bit order: MSB/LSB  
 Source: CH1 to CH4, Logic input bits

Analysis function:  
 Analyzable number of data items:40,000 bytes max.  
 Display of analysis results: Analysis results can be displayed using the following 2 methods  
 Simple analysis result list: Data (hex representation), CS signal status  
 Detailed analysis result display: Detailed analysis result list, time from the reference point, data (select and show either Binary or Hex data), and CS signal status can be displayed.

Search function:  
 Pattern search: Waveforms can be searched by specifying data pattern.  
 When a waveform that agrees with the pattern is found, the zoom box moves to the position of that waveform to show the specified waveform.

Analysis result save function:  
 Storage of analysis list data: The data can be saved to CSV-format files.

### CAN/LIN Bus Analysis Functions (optional)

Applicable bus: CAN version 2.0 A/B  
 High-speed CAN (ISO11898)  
 Low-speed CAN (ISO11519-2), LIN rev 1.3, rev 2.0  
 Bit rate: CAN 1 Mbps, 500 kbps, 250 kbps, 125 kbps, 83.3 kbps, 33.3 kbps, user-defined (100 bps resolution)  
 LIN 19.2 kbps, 9.6 kbps, 4.8 kbps, 2.4 kbps, 1.2 kbps, user-defined (10 bps resolution)

Trigger function (standard):  
 Source: CAN: CH1 to CH4: Input through differential probe  
 LIN: CH1 to CH4, Logic input bits  
 Type: CAN: SOF trigger, Frame ID trigger, Data field trigger, Remote Frame trigger, Error Frame trigger, Ack trigger, Frame ID/Data OR trigger  
 LIN: Synch Break trigger

Analysis function:  
 Analyzable number of frames: 3,000 max.  
 Analysis result display: Waveform and analysis list display  
 CAN Detailed analysis list display (Analysis display items: Frame type, time from trigger point, frame ID, DLC, Data, CRC, presence/absence of ACK)  
 LIN ID, ID-Field, Data, CheckSum, Information  
 Analysis support functions: Data search, Field jump, Stuff bit calculation  
 Analysis result save function:  
 Storage of analysis list data: The data can be saved to CSV-format files.

### Auxiliary I/O Section

Rear panel I/O signal: Ext. trigger input, ext. trigger output, GO/NO-GO I/O, video output  
 Probe interface terminal (front panel):  
 No. of terminals: 4  
 Probe power terminal (/P4 option, rear panel):  
 No. of terminals: 4

### Internal Hard Drive (/C8 Option)

Capacity/file system: 40 GB FAT32  
 File name: Supports long file names of up to 256 ASCII characters

### USB Peripheral Connection Ports

Connector: USB-type A connector x 2  
 Supported transmission standards:USB 2.0 Low Speed, Full Speed

Supported devices: USB HID Class Ver1.1-compliant mouse/109 keyboard  
 USB Printer Class Ver.1.0-compliant printers  
 USB Mass Storage Class Ver.1.1-compliant mass storage device  
 USB hub device (1 unit only)  
 \* Please contact your local Yokogawa sales office for model names of verified devices  
 Max. No. of devices: 4

### PC Card Interfaces

Number of slots: 2 (front panel (1), rear panel (1))  
 Supported cards: GPIB card (National Instruments NI PCMCIA-GPIB card),  
 Flash ATA memory card (PC card TYPE II), CF card + adapter card, and various hard disk type PC cards  
 \* Please contact your local Yokogawa sales office for model names of verified devices

### USB-PC Connection Ports

Connector: USB-type B connector x 1  
 Supported transmission standards:USB2.0 (High Speed) mode, FS (Full Speed) mode  
 Supported class: Operates as a multifunctional device simultaneously supporting the following two protocols:  
 USBTMC-USB488 (USB Test and Measurement Class Ver.1.0)  
 Mass Storage Class Ver.1.1 (formatting is not supported).

### Ethernet Communication (/C10 and /C8 Options)

Connector type: RJ-45 connector x 1  
 Transmission method: Ethernet (100BASE-TX/10BASE-T)  
 Supported services: DHCP, DNS, Microsoft network file sharing server & client, FTP server, SNTP client, SMTP client, Firewall functions, Web Server functions

### General Specifications

Rated supply voltage: 100 to 120 V AC/220 to 240 V AC (automatically selected)  
 Rated supply frequency: 50/60 Hz  
 Maximum power consumption: 300 VA  
 External dimensions: 350(W) × 200(H) × 285(D)mm (when printer cover is closed; excluding handle and protrusions)  
 Weight: Approx. 7.7 kg (excluding printer (optional))  
 Operating temperature range: 5 to 40°C

- Measured value under standard operating conditions after a 30-minute warm-up followed by calibration.  
 Standard operating conditions: Ambient temperature: 23 ±5°C  
 Ambient humidity: 55 ±10%RH  
 Error in supply voltage and frequency: Within 1% of rating
- Value in the case of a repetitive signal  
 The frequency bandwidth of a single-shot phenomenon is the smaller of the two values, DC to sampling frequency/2.5 or the frequency bandwidth of the repetitive phenomenon.
- The parallel acquisition architecture of DL9000 series MSO models ensures no decrease in acquisition rate for multichannel use.

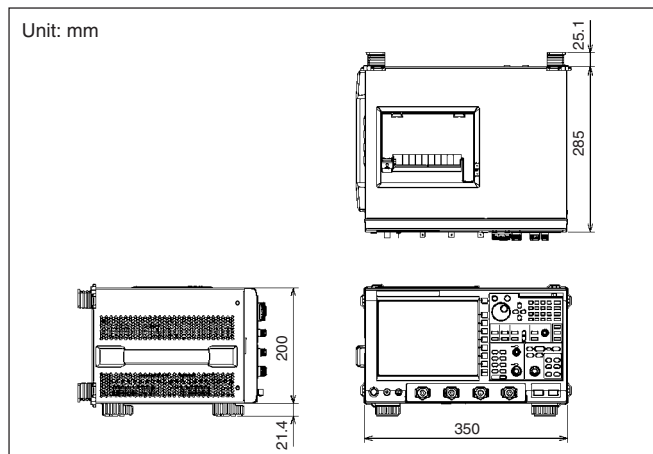

For detailed specifications, visit our homepage at <http://www.yokogawa.com/tm/DL9700>

## Model and Suffix Codes of DL9000 series MSO models

Model	Suffix Code	Description
701320		DL9505L: 4ch 500MHz + Logic 16bits Max. 5 GS/s(2.5 GS/s/ch), 6.25 MW/ch
701321		DL9510L: 4ch 1GHz + Logic 16bits Max. 5 GS/s(2.5 GS/s/ch), 6.25 MW/ch
701330		DL9705L: 4ch 500MHz + Logic 32bits Max. 5 GS/s(2.5 GS/s/ch), 6.25 MW/ch
701331		DL9710L: 4ch 1GHz + Logic 32bits Max. 5 GS/s(2.5 GS/s/ch), 6.25 MW/ch
Power Cable	-D	UL/CSA standard
	-F	VDE standard
	-Q	BS standard
	-R	AS standard
	-H	GB standard
Help menu language	-HE	English Help
Logic Probe	-L0	No Logic Probe attached
	-L2	Attach two 250 MHz Logic Probes (701981)
	-L4 <sup>1</sup>	Attach four 250 MHz Logic Probes (701981)
Options	/B5	Built-in printer
	/P4 <sup>2</sup>	4 Probe power connections on rear panel
	/C8 <sup>3</sup>	Built-in HDD + Ethernet interface
	/C10 <sup>3</sup>	Ethernet interface
	/G2 <sup>4</sup>	User-defined math function
	/G4 <sup>4</sup>	Power Supply Analysis Function
	/F5 <sup>5</sup>	I <sup>2</sup> C+SPI bus analyzer
	/F7 <sup>5</sup>	CAN+LIN+SPI bus analyzer
	/F8 <sup>5</sup>	I <sup>2</sup> C+CAN+LIN+SPI bus analyzer

\*1: Not available for DL9500 series

\*2: Please order /P4 option if you use either current probes or differential probes such as 701920, 701922.

\*3: Choose either one

\*4: Choose either one

\*5: Choose either one. I<sup>2</sup>C, CAN, LIN and SPI triggers are standard.

## Related products



## Standard Accessories

Name	Qty
Power Cable	1
3 prong-to-2 prong adapter	1
PB500 passive probe	4
Logic probe 701981 (when -L0 is specified)	—
Logic probe 701981 (when -L2 is specified)	2
Logic probe 701981 (when -L4 is specified)	4
Printer roll paper (when option /B5 is specified)	1
User's manual (1 set)	1
Front panel cover	1
Rubber leg cap (2 per order)	2
Soft case	1

\*: Available for DL9700 series only.

## Accessories (Optional)

Name	Model	Specification
PB500(10:1 passive probe)	701943	10 M $\Omega$ (10:1), 500 MHz, 1.5 m(one per order)
PBA2500 (2.5 GHz active probe)	701913	2.5 GHz BW
PBA1500 (1.5GHz active probe)	701914	1.5 GHz BW
PBA1000 (1.0GHz active probe)	701912	1.0 GHz BW
PBD2000(2.0 GHz differential probe)	701923	2.0 GHz BW
Miniature passive probe	701941	10:1, DC to 500 MHz, 1.2 m
100:1 high voltage probe	701944	DC to 400 MHz, 1.2 m
100:1 high voltage probe	701945	DC to 200 MHz, 3 m
PBL5000 (5 GHz probe)	701974	5 GHz BW
DC block	701975	For 50 $\Omega$ input, SMA connector
FET probe	700939	900 MHz BW
Logic probe	701980	1 M $\Omega$ /10 pF, 100 MHz toggle frequency
Logic probe	701981	10 k $\Omega$ /9 pF, 250 MHz toggle frequency
Differential probe	701921	DC to 100 MHz BW/Max. $\pm$ 700 V
Differential probe	701922	DC to 200 MHz BW/Max. $\pm$ 20 V
Differential probe	700924	DC to 100 MHz BW/Max. $\pm$ 1400 V
Differential probe	701920	DC to 500 MHz BW/Max. $\pm$ 30 V
Current probe	701933	DC to 50 MHz BW, 30 Arms
Current probe	701932	DC to 100 MHz BW, 30 Arms
Printer roll	B9850NX	30 m roll, 5 rolls/order
Rack mount kit for DL9700/9500	701983-01	EIA standard-compliant
	701983-02	JIS standard-compliant
MATLAB tool kit	701991	For DL series
Xviewer	701992-SP01	For DL/WE series, standard type
	701992-GP01	For DL/WE series, with computation function
Probe stand	701919	Circular Base, 1 arm

[ signalXplorer. is a registered trademark of Yokogawa Electric Corporation.]

Microsoft, MS, Windows, and Internet Explorer are registered trademarks or trademarks of Microsoft Corporation in the US and other countries.

This product's TCP/IP software and documentation on TCP/IP software were developed/manufactured by Yokogawa based on BSD Networking Software, Release1, under license from the University of California.

Other company names and product names appearing in this document are the registered trademarks or trademarks of their respective companies.

### Note



- Before operating the product, read the user's manual thoroughly for proper and safe operation.

## Yokogawa's Approach to Preserving the Global Environment

- Yokogawa's electrical products are developed and produced in facilities that have received ISO14001 approval.
- In order to protect the global environment, Yokogawa's electrical products are designed in accordance with Yokogawa's Environmentally Friendly Product Design Guidelines and Product Design Assessment Criteria.

# YOKOGAWA

YOKOGAWA ELECTRIC CORPORATION  
Communication & Measurement Business Headquarters /Phone: (81)-422-52-6768, Fax: (81)-422-52-6624  
E-mail: tm@cs.jp.yokogawa.com

YOKOGAWA CORPORATION OF AMERICA Phone: (1)-770-253-7000, Fax: (1)-770-251-6427  
YOKOGAWA EUROPE B.V. Phone: (31)-33-4641858, Fax: (31)-33-4641859  
YOKOGAWA ENGINEERING ASIA PTE. LTD. Phone: (65)-62419933, Fax: (65)-62412606

Subject to change without notice.  
[Ed : 02/b] Copyright ©2007  
Printed in Japan, 707(KP)