



SMARTDAC+

Data Acquisition & Control

Data Acquisition System GM

SMARTDAC+[®]

Data Acquisition & Control

Your business environment is complex and rapidly changing.

You need smart and powerful systems that can adapt to your process.

SMARTDACPLUS[®] is a fresh approach to data acquisition and control, with smart and simple touch operation as a design priority.

Measure, display and record process data with greater levels of clarity, intelligence and accessibility.

The **SMARTDACPLUS[®]** concept started with the GX/GP, an integrated I/O and recording system with a familiar touch operator interface.

Building upon the **SMARTDACPLUS[®]** product family is the highly adaptable, scalable and easy to operate GM data logger.

Now that's SMART.



Precise, Reliable & Adaptable

Decades of Yokogawa's innovative measuring technology has resulted in a flexible data logger that offers both reliability and ease of use.

Scalability

Up to 420 ch per system / Plug and lock modules

Ease of Use

Web-based configuration / Live Web-based data viewing

Mobile Connectivity

Bluetooth / Mobile Application

Open Network

Modbus, EtherNet/IP, SLMP, and OPC-UA server

Reliability

Secure data storage / High accuracy measurement

Noise Tolerance

Electromagnetic relay module



..... → **What's New**

- PID control (GX90UT PID Control Module)
- Program control (/PG option)
- Dual interval measurement
- High speed (1 ms) measurement (GX90XA-04-H0 High Speed AI Module)
- 4-wire RTD input, resistance measurement (GX90XA-06-R1 4-Wire RTD Module)
- Retransmission/manual mA output (GX90YA Analog Output Module)



Ready for the future when you are
Smart Architecture



Navigate with ease
Smart User Interface



Data analysis made simple and mobile
Smart Functionality

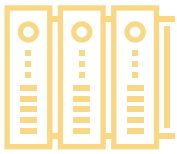

Ready for the future when you are Smart Architecture

Increase channels by adding additional block modules

YOKOGAWA proprietary block architecture [Patent technology]

- Expand one, or multiple module at a time
- Unique design houses modules in linked module bases
- Module base ensures linkage (slide locks and mounting screws also available)
- Modules can be inserted and removed from the front panel for easy maintenance

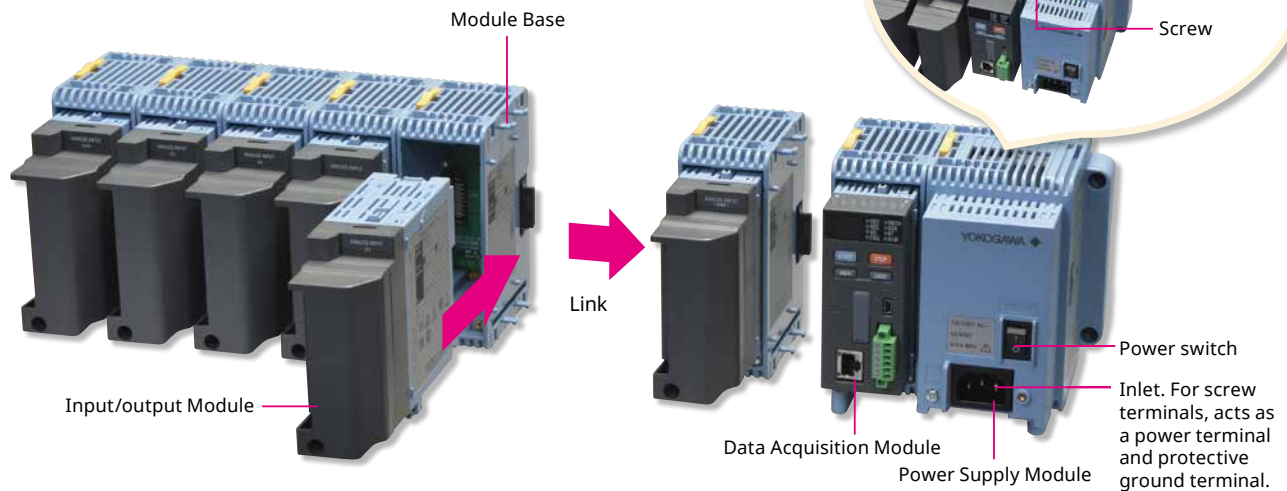

Names of data acquisition module parts

- 7 segment LED (x2)
(Displays operation mode, system number, and other information)
- USER key (Executes specified actions)
- SD memory card slot
- Ethernet port
A 10Base-T/100Base-TX port.

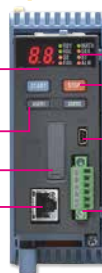

- Status display (Displays system status)
- START/STOP key
(Starts/stops recording and computation)
- USB port (USB2.0 compliant port for hardware settings and the GA10, or customer created communication programs)
- Serial communications port
(Optional code, /C3)

Comes standard with support for up to 100 ch of measurement (single-unit configuration)

Up to 10 I/O modules can be linked to a single data acquisition module (GM10)



Up to 10 modules linked

Installs anywhere

For the desktop, DIN rails, or wall-mounting.
No special attachments required.

Desktop



Mounted on DIN rails



Wall-mounted



Select from a wide range of I/O modules

Select modules according to your application. Noise-resistant, magnetic relay types also available. All modules have removable terminal blocks for easy wiring. The same modules used in the SMARTDAC+ series.

Model	Name	Measurement/Application	Channels
GX90XA-10-U2	Analog input module	DC voltage, DC current (with external shunt resistor connected), thermocouple, RTD, contact (solid state relay scanner type)	10
GX90XA-10-L1		DC voltage, DC current (with external shunt resistor connected), thermocouple, contact (Low withstand voltage solid state relay scanner type)	10
GX90XA-10-T1		DC voltage, DC current (with external shunt resistor connected), thermocouple, contact (electromagnetic relay scanner type)	10
GX90XA-10-C1		DC current (mA) (solid state relay scanner type)	10
GX90XA-04-H0		DC voltage, DC current (with external shunt resistor connected), thermocouple, RTD, contact (individual A/D type)	4
GX90XA-06-R1		4-wire RTD, 4-wire resistance(solid state relay scanner type)	6
GX90YA	Analog output module	Current output (Isolated between channels)	4
GX90XD	Digital input module	Remote control input or operation recording	16
GX90YD	Digital output module	Alarm output	6
GX90WD	Digital input/output module	Remote control input or operation recording/alarm output	DI:8/DO:6
GX90XP	Pulse Input Module	Pulse signal data acquisition, integral count	10
GX90UT	PID control module	PID control (2 loop)	AI:2/AO:2 DI:8/DO:8



SMARTDAC+ series



You can attach and remove I/O terminals. This saves time and effort on wiring.

Analog input module scan interval and measurement type

Type	Channels	Scan interval (shortest)	Scanner	TC	RTD	DCV	DI	mA	Resistance	Feature
Universal (-U2)	10	100ms	SSR	○	○	○	○			Universal
Low withstand voltage relay (-L1)	10	500ms	SSR	○		○	○			Mid-price
Electromagnetic relay (-T1)	10	1s	Relay	○		○	○			Noise-resistance
DC current input (-C1)	10	100ms	SSR					○		mA only
High speed universal (-H0)	4	1ms	—	○	○	○	○			High speed measurement
4-wire RTD/resistance (-R1)	6	100ms	SSR		○				○	4-wireRTD

Internal memory and max. I/O channels

Type	Internal memory	Max. input/output channels*	
GM10-1	500MB	Single-unit configuration	0 to 100
		Multi-unit configuration	0 to 100
GM10-2	1.2GB	Single-unit configuration	0 to 100
		Multi-unit configuration	0 to 420

* When analog input only

Actual values support high precision measurement

Input type	Measuring accuracy*1 (typical value*2)
DCV	20mV: $\pm(0.01\% \text{ of rdg} + 5 \mu\text{V})$
	60mV: $\pm(0.01\% \text{ of rdg} + 5 \mu\text{V})$
	6V(1-5V): $\pm(0.01\% \text{ of rdg} + 2 \text{ mV})$
TC ⁻³	R: $\pm 1.1^\circ\text{C}$
	K: $\pm(0.01\% \text{ of reading} + 0.2^\circ\text{C})$ However, -200.0 to 0.0°C : $\pm(0.15\% \text{ of reading} + 0.2^\circ\text{C})$
	K (-200 to 500 °C): $\pm 0.2^\circ\text{C}$ However, -200.0 to 0.0°C : $\pm(0.15\% \text{ of reading} + 0.2^\circ\text{C})$
	J: $\pm 0.2^\circ\text{C}$ However, -200.0 to 0.0°C : $\pm(0.10\% \text{ of reading} + 0.2^\circ\text{C})$
	T: $\pm 0.2^\circ\text{C}$ However, -200.0 to 0.0°C : $\pm(0.10\% \text{ of reading} + 0.2^\circ\text{C})$
	N: $\pm(0.01\% \text{ of reading} + 0.2^\circ\text{C})$ However, -200.0 to 0.0°C : $\pm(0.22\% \text{ of reading} + 0.2^\circ\text{C})$
RTD	Pt100: $\pm(0.02\% \text{ of rdg} + 0.2^\circ\text{C})$
	Pt100 (high resolution): $\pm(0.02\% \text{ of rdg} + 0.16^\circ\text{C})$

The measuring accuracies noted in the general specifications on page 15 have a margin of error that takes into account the product's components and the equipment used for adjustment and testing. However, the actual values calculated from the accuracy testing data upon shipment of the instrument from the factory are listed to the left.

- *1 Applies to GX90XA-10-U2, A/D integration time 16.67ms or more, General operating conditions: $23 \pm 2^\circ\text{C}$, $55 \pm 10\% \text{ RH}$, supply voltage 90-132, 180-264V AC, power frequency within 50/60Hz $\pm 1\%$, warm-up of 30minutes or more, no vibrations or other hindrances to performance.
- *2 For the measuring accuracy (guaranteed), see the module's general specifications (GS 04L53B01-01EN).
- *3 These values do not include the reference junction compensation accuracy.

Support measurement of up to 420 ch (actual input) by expanding channels across multiple units (multi-unit configuration)

Expand up to 420 ch by using the GX90EX expansion module. (GM10-2)
On the GM10-2 large capacity type, up to 1000 ch are available for recording when including MATH and communication channels.
Connect units with LAN cables for dispersed installations.

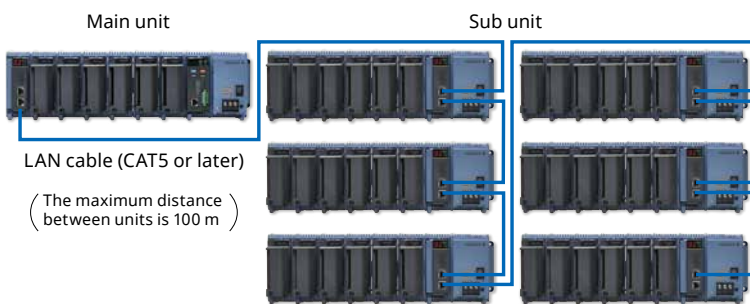

You connect directly with a LAN cable without connecting through a hub or repeater.
* You can also connect a GX60 expansion unit.

Reduce wiring with distributed installation

When the data logger is installed offsite (away from the DUT), you can place the sub unit at the site and monitor data without the need for long-distance wiring of thermocouples and other sensors.

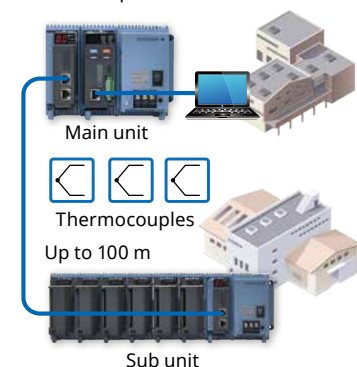



Navigate with ease Smart User Interface

Easy access from a Web browser

Through a Web browser you can monitor the GM in real time and change settings. You can easily build a seamless, low-cost remote monitoring system with no additional software.

Real time monitoring screen

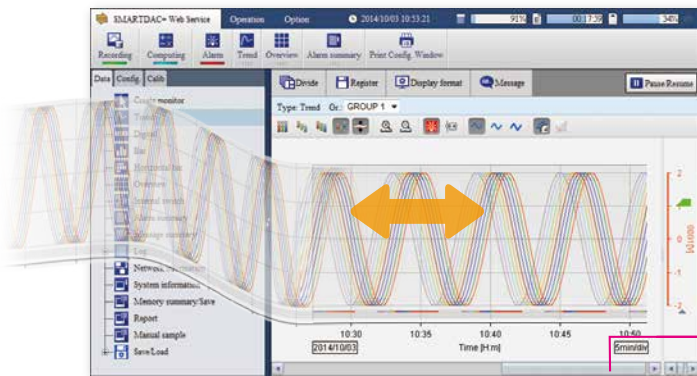

With the scroll bar, you can seamlessly scroll between past and current trends.

Enter settings online with a web browser

AI	Type	Range	Span Lower	Span Upper	Calculation
0001	Volt	2V	-2.0000	2.0000	Off
0002	Volt	2V	-2.0000	2.0000	Off
0003	Volt	2V	-2.0000	2.0000	Off
0004	Volt	2V	-2.0000	2.0000	Off
0005	Volt	2V	-2.0000	2.0000	Off
0006	Volt	2V	-2.0000	2.0000	Off
0007	Volt	2V	-2.0000	2.0000	Off
0008	Volt	2V	-2.0000	2.0000	Off
0009	Volt	2V	-2.0000	2.0000	Off
0010	Volt	2V	-2.0000	2.0000	Off

The setting screen lets you copy AI channel settings and other information to Excel for editing. You can reimport the data into the setting screen after editing.

	A	B	C	D	E	F	G	H	I	J	K	L
1	1	RTD	PH:00	0	150	Off	1	2	0	100	off	
2	2	RTD	PH:00	0	150	Off	1	2	0	100	off	
3	3	RTD	PH:00	0	150	Off	1	2	0	100	off	
4	4	RTD	PH:00	0	150	Off	1	2	0	100	off	
5	5	RTD	PH:00	0	150	Off	1	2	0	100	off	
6	6	RTD	PH:00	0	150	Off	1	2	0	100	off	
7	7	RTD	PH:00	0	150	Off	1	2	0	100	off	
8	8	RTD	PH:00	0	150	Off	1	2	0	100	off	
9	9	RTD	PH:00	0	150	Off	1	2	0	100	off	
10	10	RTD	PH:00	0	150	Off	1	2	0	100	off	
11												
12												

Trend, digital, and other real-time displays

Trend

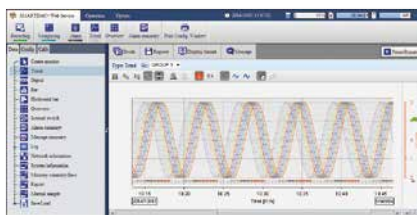

Bar graph



Alarm/Message/Memory summary

Digital

0001	1.7321	0.5176	-1.0000	-1.9319
0002	1.4142	0.0000	-1.4142	
0003	1.0000	-0.5176	-1.7321	

Overview

0001	0.1047	-1.8051
0002	-0.4188	-1.9975
0003	-0.8080	-1.9643
0004	-1.3385	-1.7839
0005	-1.8772	-1.4863

Dedicated software (free download) is available for loading waveforms and GM settings

Universal viewer

Data files saved on the GM can be viewed and printed. You can perform statistical computation over an area and export to ASCII, Excel, or other formats.

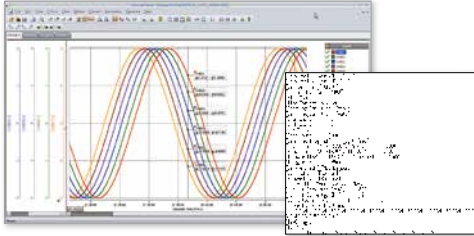

Data converted to an ASCII file

Offline setting software

Save settings or transfer them to the GM. Connections can also be made easily via USB or Bluetooth.

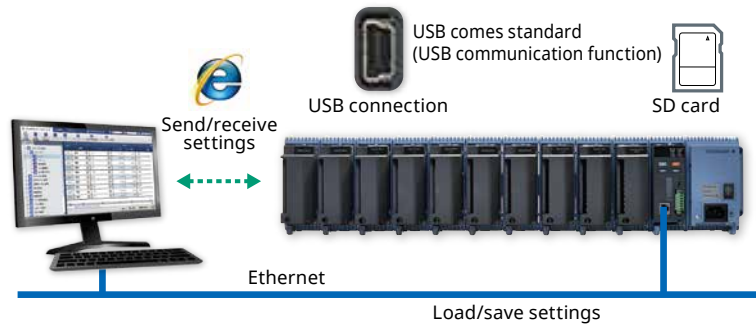

Safe to use in a wide range of temperatures

With operating temperatures of -20°C – 60°C , it supports a wide range of applications in varying installation environments.



Environmental testing

Monitoring and settings can also be done on a tablet

Supports Bluetooth (optional code /C8)

You can enter settings or monitor from a tablet without ever bringing a PC to the site.

Dedicated applications is available for free download. For more information, visit our website.

Monitoring and settings are available via Bluetooth



Bluetooth supports Android only.
Wi-Fi supports both Android and iOS.

Enables monitoring via Wi-Fi

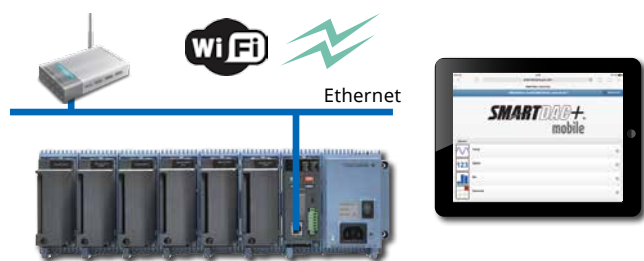

Powerful applications

Bluetooth connection

Simple to use for in-vehicle testing.



USB connection

Service staff can easily perform maintenance on the GM.





Data analysis made simple and mobile

Smart Functionality

High speed measurement (down to 1 ms)

Yokogawa's proprietary A/D converter allows the high speed module to measure data points as fast as 1ms.

- High speed (1 ms) measurement*
- Proprietary A/D converter

* With 1ch per module.
At 2 ms, 2 ch per module, and at 5 ms or more, all 4 ch per module.

Max. channels

Model	Scan interval		
	1ms	5ms	10ms
GM10-1	1ch	5ch	10ch
GM10-2	5ch	25ch	32ch

New



GX90XA-04-H0
Analog input module (high speed AI)

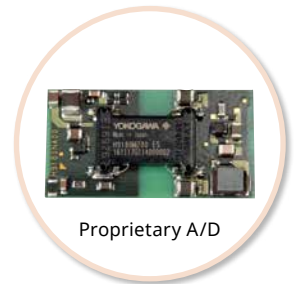

Proprietary A/D

Dual interval measurement with two different scan intervals

Users have the ability to choose two different scan intervals on a single GM system. This allows users the flexibility to measure various types of inputs with two different scan intervals in a single system.

For example, this provides for efficient, simultaneous measurement of signals with slow fluctuations such as temperature, and fast-changing signals such as pressure and vibration. Modules can be assigned to measurement groups.

2 measurement groups

The figure above shows 2 measurement groups by color.

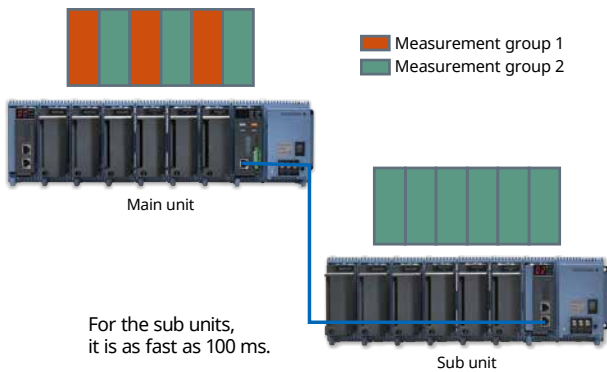

Superimpose data on Universal Viewer

With Universal Viewer, you can superimpose measured data from 2 measurement groups.

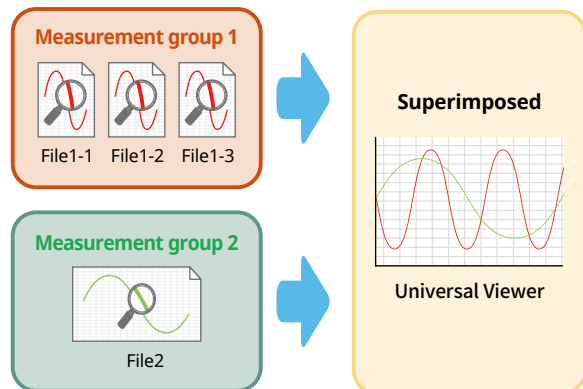

Application examples

Acquire temperature and vibration data from power plant turbines

- Monitoring and recording of alarms when abnormal temperature or vibration are detected
- At 5 ms sampling, reliably detect abnormalities
- Dual interval multipoint measurement



Measures LCD projector overheating

- Evaluates the rise in temperature of parts near the projector lamp, and the drop in temperature after powering OFF
- At 10 to 1 ms sampling, record steep temperature changes in detail



Car battery charge/discharge test

- Measures transient current during charging and discharging
- Sampling requirement: 1 ms

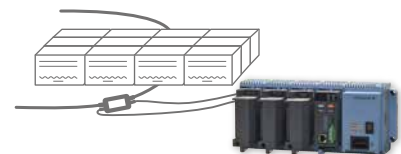

PID control function

Control function

Enables PID and program control

- PID control module
2-loops per module, up to 20 loops per system
- Setpoint program control function (/PG option)
Up to 99 patterns

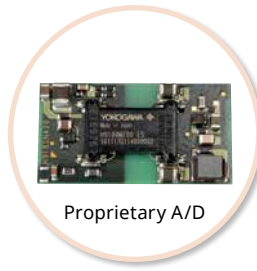

Remote operation and monitoring

The web application enables remote operation and monitoring from a browser.



With the Web Server function, simply access the GM from a web browser on a PC for easy operation and monitoring of control loops.

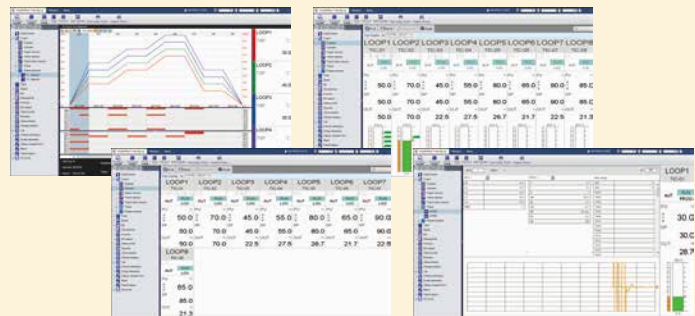

Application examples

Industrial furnace

- Ideal for **centralized control of multiple loops**
- **Modular structure makes for easy maintenance** of individual loops

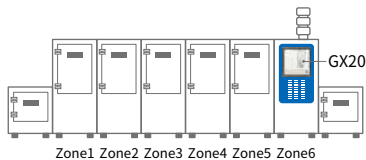

Utility equipment

- Simplifies loop control and **remote monitoring** of utility equipment
- Readily scalable for **additional loops**

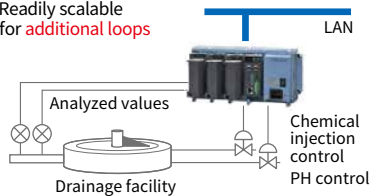

Engine endurance test bench

- Measures evaluation data while **generating test patterns**

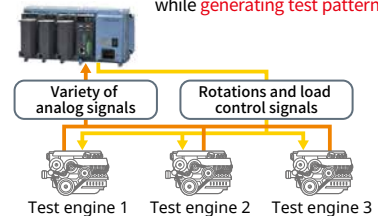

MATH (including reports), and event actions

MATH function (/MT option)

Supports various kinds of math computation, including basic math and functions (square root, logarithms, trigonometry). Write formulas using variables for measured or computed data and save or display the results—this saves time and effort on post-processing. Create hourly, daily, monthly, and other reports with the Report function.

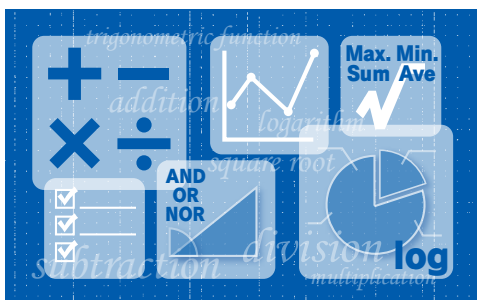

Event actions

Ability to assign actions tied to specific events during the operation of the data acquisition station.

Event

- Alarm
- Relay
- Match time timer
- Remote
- Timer
- Internal switch
- User function key, etc.

Action

- Record start/stop
- MATH start/stop
- Manual sample
- Alarm ACK
- Message
- Event trigger
- Reset timer
- Relay ON/OFF, etc.

Aerospace Heat Treatment Supports heat treatment application AMS2750/NADCAP

Calibration correction schedule control function (/AH option)

Schedule management for periodically executing calibration correction configuration and the like. You can set the input correction factor as a sensor correction factor and instrument correction factor. TUS software is available for easily creating TUS (temperature uniformity survey) reports.

* For details on TUS software, consult with your Yokogawa dealer.

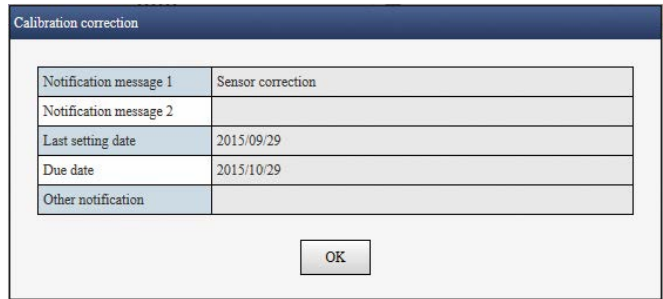

Input calibration is performed in the AI channel setting screen, and the calibration period settings are entered in the schedule management setting screen.

Record data in separate files per equipment set

Multi-batch Function (/BT option)

Record pre-defined channel groups to separate data files with independent start and stop control. You can create up to 12 batches.

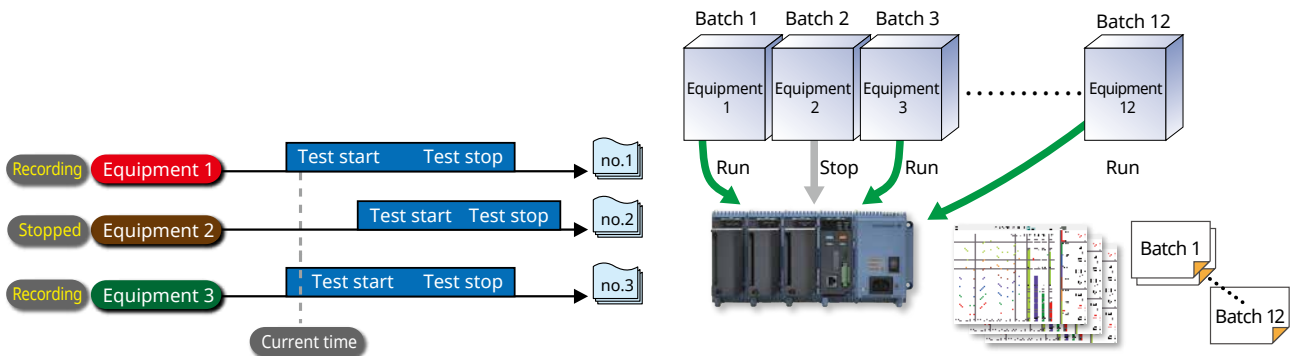

Report creation and network functions (/MT option)

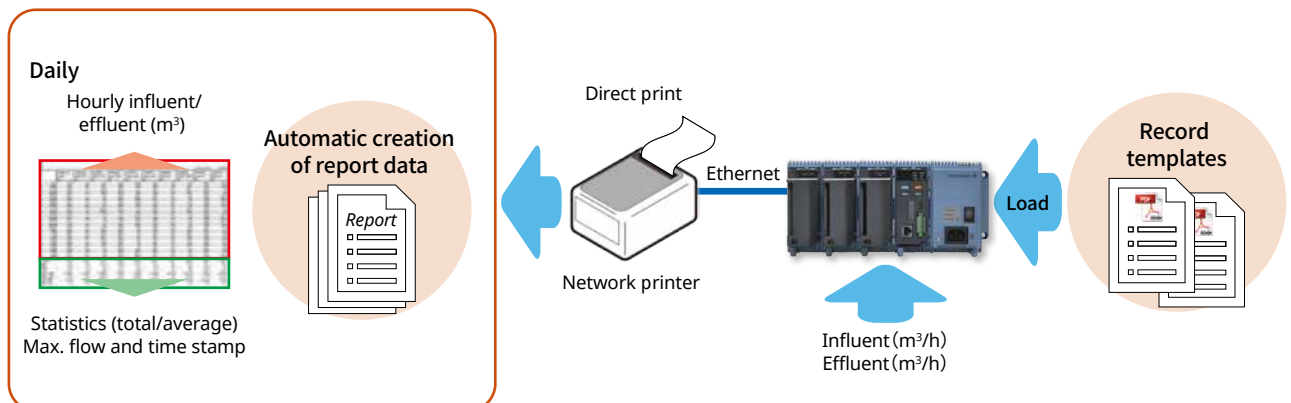



Provides a variety of convenient networking functions

Networking

Modbus/TCP and Modbus/RTU Communications

GM supports Modbus TCP/IP client and server modes for Ethernet communications and Modbus RTU master and slave modes for optional serial communications.

Modbus/TCP (Ethernet connection), Modbus/RTU (RS-422/485 connection)

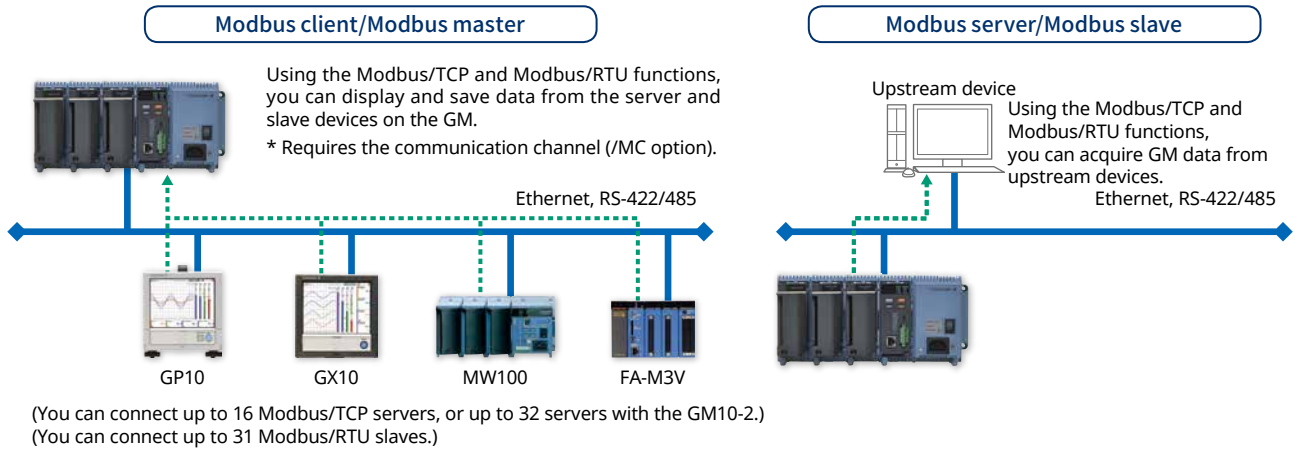

EtherNet/IP Function (/E1 option)

GM supports EtherNet/IP server functions. You can access GM from PLCs or other devices and load measurement/MATH channels or write to communication input channels* (GM10-1: up to 300 ch, GM10-2: up to 500 ch).

* Communication channel function (/MC option) is required.

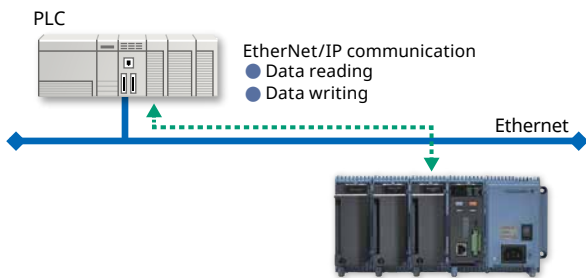

CC-Link family SLMP communication (/E4 option)

Protocol function that enables connection from a GM to Mitsubishi Electric PLCs without sequencer programs. The GM can run as the SLMP client to write to a GM measured data PLC, or PLC data to communication channels*.

* Requires the communication channel option (/MC option).

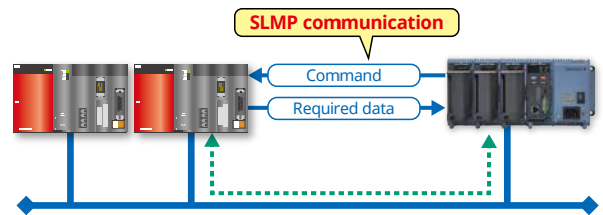

Data acquisition on power measuring instruments (/E2 and /MC options)

Acquire precise digital data on the GM by digital communication connectivity to a power measuring instrument (WT series power analyzers) and record it along with the GM's measured data. Since it records a device's power consumption, temperature, and other phenomena at the same time, the GM is ideal for performance evaluation testing.

Models that can be connected
Yokogawa Meters & Instruments Corp.
WT1800/WT1800E (command type WT1800), WT500
WT300/WT300E (command mode WT300)

Max. no. of connections 16

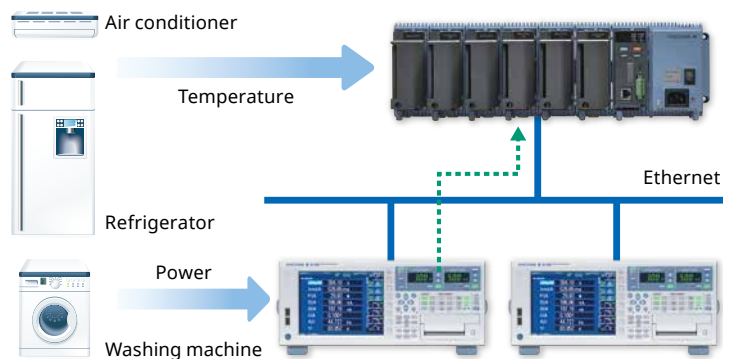

OPC-UA Server (/E3 option)

Data acquired by the GM can be accessed through Ethernet communication from a host system (OPCUA client). Writing from upstream systems to GM communication channels requires the communication channel function (/MC option).

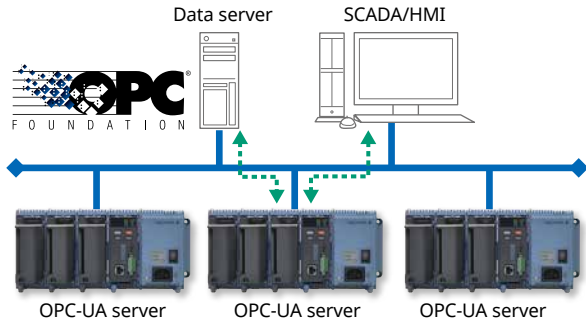

Comes with communication functions that are compatible with the DARWIN data acquisition unit

The GM supports DARWIN communication commands. Use your current DARWIN communication programs as-is on the GM. It's easy to switch from an existing DARWIN unit.

* See your dealer or nearest Yokogawa representative for details.

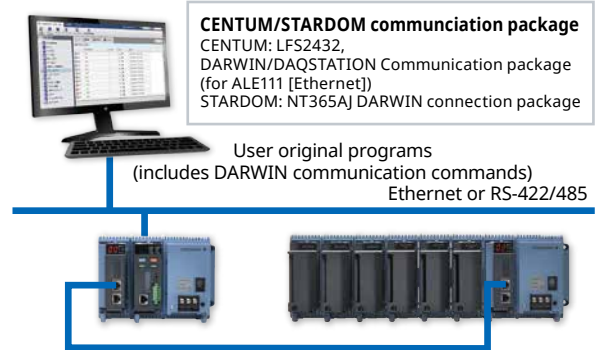

FTP-based file transfer

The FTP client/server functions allow you to easily share and manage data from a centralized file server

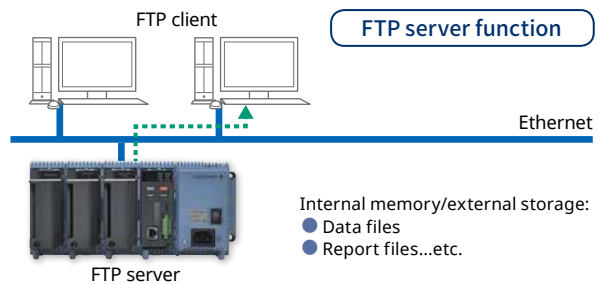
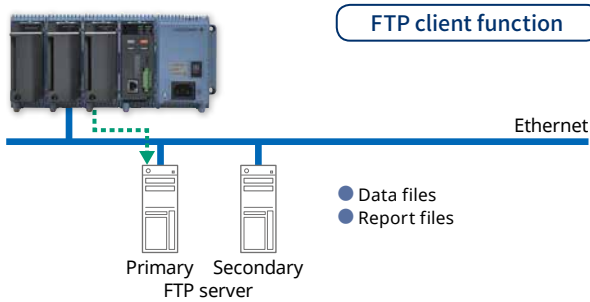

E-mail messaging function

The GM can send a variety of informative e-mail messages that include alarm notification reports, periodic instantaneous data values, scheduled report data and other information.

Sending e-mail using an existing mail system

In this type of setup, e-mail messages are sent through an existing mail server (SMTP server).

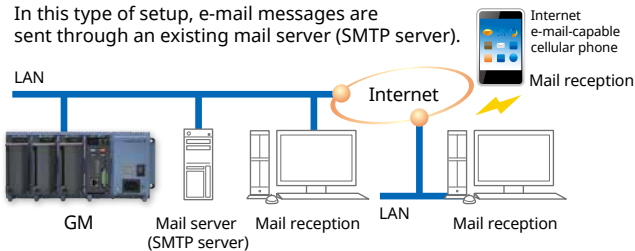

Time synchronization with network time servers

GM uses SNTP protocol in client mode to acquire time information from a network time-server. This function allows any number of GM units within a facility to have precisely synchronized time; all units will record data with coordinated date and time stamp information. In addition, GM can function as a server, providing time data to other SNTP client units on the network.

Automatic network setup (DHCP) function

Using Dynamic Host Configuration Protocol (DHCP), the GM can automatically acquire the settings it needs (IP address) for network communications from a DHCP server. This makes it easier than ever to install the unit on a plant network.

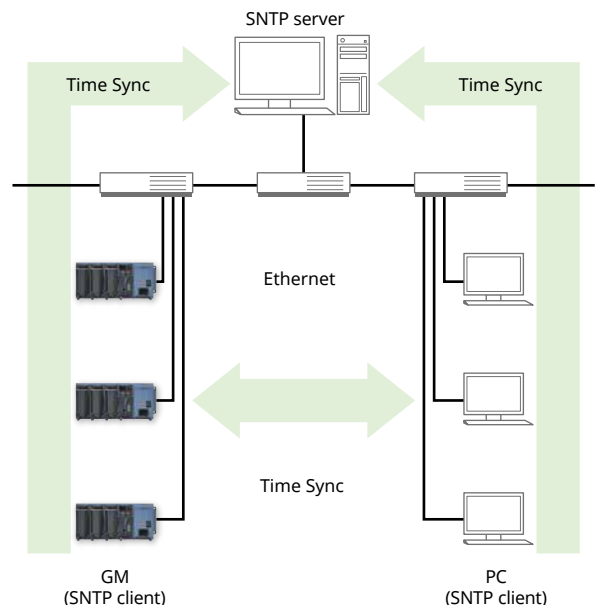
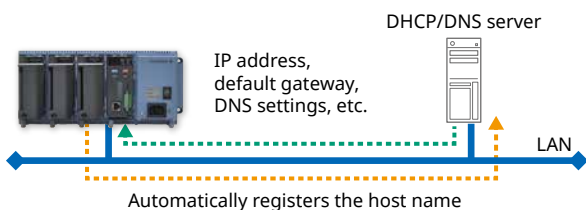



Rock-solid hardware and highly secure

Reliability and durability

Be confident that recorded data is saved

Supports long-duration and multichannel recording. Measured data is always stored to internal memory, and data is transferred to external storage media at regular intervals. Redundancy can be achieved by sending data to a server with the FTP client function. Securely saves measured data even in the event of a sudden power loss.

Approximate sample time

Number of recording channels	Total sample time
30	Approx. 71 days
100	Approx. 23 days
300	Approx. 7 days

With an internal memory of 1.2 GB and recording interval of 1 sec.

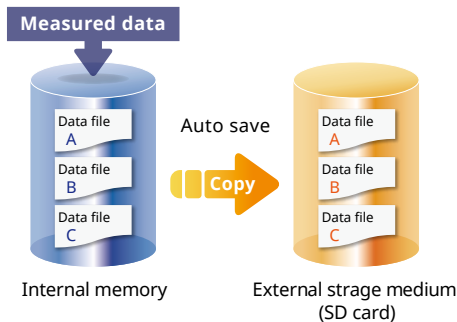

Select file formats according to your application

For increased security, measured data can be saved in binary format. This format is very difficult to decipher or modify in traditional text editors or other programs. To enable easy and direct opening of the data in text editors or spreadsheet programs, choose text format. This allows you to work with your measurement data without dedicated software.

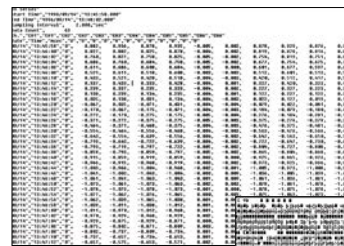

ASCII data display



Binary data display

Security enhancements

Safely sends and receives customer data.

SSL support function

- FTP client
- SMTP client
- FTP server
- HTTP server

Digital signatures

- Add electronic signatures to records (PDF)



SSL: An encryption protocol for data sent over TCP/IP networks.

21 CFR Part 11 support (IAS option)

With the advanced security function option, GM supports the USA FDA's Title 21 CFR Part 11 regulations (for the pharmaceutical manufacturing industry).

It gives you access to a login function for requiring user names, IDs, and passwords, plus electronic signatures, audit trails, an anti-tampering function, an Active Directory-based password management function, and other security features.



FDA 21 CFR PART 11

Key lock

You can use settings to lock the GM10 operation keys in order to avoid accidental start/stop of measurement or computation.



Analog front end module

A proprietary A/D converter delivers high speed, high precision data acquisition. (High-speed AI, PID Control module)



Specifications

For detailed specs, see the general specifications (data acquisition module/power supply module/module base: GS 04L5B01-01EN, expansion unit/expansion modules: GS 04L5B00-01EN, I/O modules: GS 04L5B01-01EN, PID control module: GS 04L5B01-31EN).

GM10 Data Acquisition Module	
No. of I/O channels:	GM10-1: 100 max. GM10-2: 500 max. (or 420 with AI only)
Measurement mode:	Normal, High speed ¹ , Dual interval * Compatible modules: High-speed AI (GX90XA-04-H0)
Scan interval:	1/2.5/10/20/50/100/200/500ms/1/2/5s * Some intervals not available depending on system configuration and modules.
Internal memory (flash memory):	GM10-1: 500 MB GM10-2: 1.2 GB
External storage media:	SD memory card (SD/SDHC), up to 1-32 GB (1 GB incl.) Format: FAT32 or FAT16
Data types:	Event, display, alarm summary, manual sample, settings, and report (/MT option)
Data format:	Binary or text
Alarms:	Number: Max. 4 alarms per measurement channel Types: high limit, low limit, difference high limit, difference low limit, rate of change increase, rate of change decrease, delay high, delay low
Event actions:	Specified actions can be performed when certain events occur. Number: 50 Events: alarms, remote control input, etc.; Actions: record stop/start, alarm ACK, etc. Timers: 12 Match time timers: 12
Batch function:	Manage data by batch name. Enter text fields and batch comments in data files.
Calibration correction mode:	Off, linearizer approximation, linearizer bias
Security functions:	Key lock and login functions.
Insulation resistance:	Between RS-422/485/Ethernet terminals and internal circuitry: 20 MΩ or greater (at 500 VDC)
● Ethernet	
Electrical/mechanical specifications:	IEEE 802.3 compliant (Ethernet frame type: DIX specification)
Implemented protocols:	TCP, UDP, IP, ICMP, ARP, DHCP, HTTP, FTP, SMTP, SNMP, Modbus, dedicated protocol, SSL, DARWIN-compatible communication
● USB communication	
Standards conformity:	USB 2.0 compliant (recognized as a serial port by the PC)
Connector format/no. of ports:	mini B/1
Implemented protocol:	Dedicated protocol
● RS-422/485 (/C3 option)	
Media:	EIA RS-422/485 compliant
Implemented protocol:	Dedicated protocol, Modbus/RTU, or DARWIN compatible communication
● Bluetooth (/C8 option)	
Standards conformity:	Bluetooth® Ver 2.1+EDR compliant
Supported profiles:	SPP (serial port profile)
Communication range:	Approx. 10 m (depending on operating environment) (Class2)
Implemented protocol:	Dedicated protocol
● EtherNet/IP communications (/E1 option)	
Can join Ethernet/IP networks as an adapter (server).	
Max. connections:	20 (or 10 max. at TCP/IP level)
Supported protocols:	EIP/PCCC, EIP/native
Messaging:	Explicit (UCMM Class 3) +I/O (Class 1)
Objects:	Assembly, PCCC, Data Table
● WT communication (/E2 option)	
Models supported:	WT1800/WT1800E (command type WT1800), WT500, WT300/WT300E (command mode WT300)
Supported communication:	Ethernet
Max. connected units:	16
Communication interval:	500 ms/1 s/2 s/5 s/10 s/20 s/30 s
Acquirable data types:	Voltage, current, power, power factor, phase, watt hours, harmonics, and others.
Max. data assignments:	300
● OPC-UA Server (/E3 option)	
Communication:	
Type:	OPC-UA Server
Encoding:	UA Binary
Protocol:	OPC UA TCP
Maximum number of connections:	3 sessions
Profile:	Micro Embedded Device Server
Data acquisition:	Measurement channel, computation channel, communication channel value and alarm status
Data writing:	Measurement channel (DO channel only), communication channel
Port number:	4840 (changeable: 1 to 65535)
Number of items:	300 max. (MonitoredItem/Session)
Fastest period:	100 ms
● SLMP Communication (Mitsubishi PLC) (/E4 option)	
Number of connection destination servers:	16 max.
Read cycle:	100 ms, 200 ms, 500 ms, 1 s, 2 s, 5 s, 10 s, 20 s, 30 s, 1 min
Communicable internal data:	Special relay (SM), special register (SD), input (X), output (Y), internal relay (M), latch relay (L), annunciator (F), edge relay (V), link relay (B), data register (D), link register (W), timer contact (TS), timer coil (TC), current timer value (TN), integration timer contact (SS), integration timer coil (SC), current integration timer value (SN), counter contact (CS), counter coil (CC), current counter value (CN), special link relay (SB), special link register (SW), direct access input (DX), direct access output (DY), index register (Z), file register (R, ZR), extended data register (D), extended link register (W) Device code is indicated in parentheses.
● Program control (/PG option)²	
GX90UT PID control module is required. SMARTDAC + Hardware Configurator is required for program pattern setting.	

Number of program pattern sets:	99 max. (Program patterns of up to 20 loops ³ can be stored in a single set.)
Number of segments:	99 segments/pattern
● MATH (with Report function, /MT option)	
No. of MATH channels:	GM10-1: 100, GM10-2: 200
MATH types:	Basic math, statistics, special operators, conditional statements, and others.
● Communication channels (/MC option)	
No. of communication channels:	GM10-1: 300 (C001-C300) GM10-2: 500 (C001-C500)
● Log scale (/LG option)	
Input types:	LOG input, pseudo log (input that supports pseudo log), LOG linear (linear input within the log decade)
Scalable range:	LOG input: 1.00E-15 to 1.00E+15 (max. 15 decades), [scale low limit] < [scale high limit] Pseudo log input/LOG linear: 1.00E-15 to 1.00E+15 (max. 15 decades), the mantissa of the scale low and high limits are assumed to be the same.
● Multi-batch Function (/BT option)	
Number of multi batches:	GM10-1: 6 max., GM10-2: 12 max.
● Aerospace Heat Treatment (/AH option)	
Number of manageable schedules:	GM10-1: 6 max., GM10-2: 12 max.
Calibration correction mode:	Off, linearizer approximation, linearizer bias, correction coefficient
Number of set points:	2 to 12
GM90PS Power Supply Module	
Rated supply voltage:	100-240 VAC, 12-28 VDC (GM90PS-1N2W0)
Operating supply voltage:	90-132 VAC, 180-264 VAC, 10-32 VDC (GM90PS-1N2W0)
Power frequency (AC power supply):	50 Hz ± 2%, 60 Hz ± 2%
Insulation resistance:	Between power terminal and earth: 20 MΩ or more (at 500 VDC)
Withstand voltage:	Between power terminal and earth: 3000 VAC (50/60 Hz), 1 minute 1000 VAC (50/60 Hz) for 1 minute (GM90PS-1N2W0)
GX90XA Analog Input Module	
Universal input (-U2), low withstand voltage relay (-L1), electromagnetic relay (-T1), High-speed universal (-H0), 4-wire RTD/resistance (-R1)	
Inputs:	Universal / Low withstand voltage relay / Electromagnetic relay: 10, High-speed universal: 4, 4-wire RTD/resistance: 6
Input types:	Universal, High-speed universal: DC voltage, standard signal, thermocouple, RTD, DI (voltage contact), DC current (with external shunt resistor connected) Low withstand voltage relay, electromagnetic relay: DC voltage, standard signal, thermocouple, DI (voltage, contact), DC current (with external shunt resistor connected) 4-wire RTD/resistance: 4-wire RTD, 4-wire resistance
Integral time:	Universal: 1.67 ms/16.7 ms/20 ms/36.7 ms/100 ms Low withstand voltage relay, electromagnetic relay: 16.7 ms/20 ms/36.7 ms/100 ms
Input calculation:	Linear scaling, square root, differential calculations
Input range/accuracy:	Refer to the Measurement range and accuracy table.
Input resistance:	10 MΩ or more for thermocouple/DC voltage (1 V range or lower) Approx. 1 MΩ for DC voltage (2 V range or higher)/standard signal
Input external resistance:	2 kΩ or lower for thermocouple/DC voltage
Effect of signal source resistance:	± 10 μV/1 kΩ or lower for thermocouple/DC voltage (1 V range or lower) ± 0.15%/1 kΩ or lower for DC voltage (2 V range or higher)/standard signal
Allowable wiring resistance:	Max. 10 Ω/1 wire or less (lead resistance between 3 wires is equal) for RTD input
Effect of wiring resistance:	± 0.1°C/10 Ω (lead resistance between 3 wires is equal) for RTD input
Reference junction compensation accuracy:	Measurement of 0°C or higher, input terminal temp. balanced Type K, E, J, T, N, XK GOST: ± 0.5°C (23°C ± 2°C), ± 0.7°C (0 to 50°C), ± 1.0°C (-20 to 60°C) Type R, S, W, L, U, W97Re3-W75Re25, platinum 2, NiNiMo, W/WRe26, N(AWG14): ± 1.0°C (23°C ± 2°C), ± 1.4°C (0 to 50°C), ± 2.0 (-20 to 60°C) Type KpvsAu7Fe: ± 1.0 K (23°C ± 2°C), ± 1.4 K (0 to 50°C), ± 2.0 K (-20 to 60°C) Type B, PR20-40: RJC fixed at 0°C * Parentheses () = ambient temperature.
Allowable input voltage:	± 60V DC for DC voltage (2 V range or higher)/standard signal ± 10 V DC for other conditions.
Noise rejection ratio:	Normal mode: 50/60 Hz no rejection (integral time 1.67 ms), 40 dB or more (integral time 16.67 ms or more) Common mode: 80 dB or more (integral time 1.67 ms), 120 dB or more (integral time 16.67 ms or more)
Max. common mode voltage:	30 VACrms (50/60Hz), or 60 VDC (however, max. common mode noise voltage of measurement input is 250 VACrms) High-speed universal: 300V ACrms (50/60Hz)
Max. voltage between measurement input channels:	Universal, electromagnetic relay, 4-wire RTD/resistance: 30 VACrms (50/60Hz), or 60 VDC (however, max. common mode noise voltage between measurement input channels is 250 VACrms) Low withstand voltage relay: 30 VACrms (50/60Hz), or 60 VDC (however, max. common mode noise voltage between measurement input channels is 60 VACrms) High-speed universal: 300V ACrms (50/60Hz)
Effects of ambient temperature:	Applies when integral time is 16.67 ms or higher, ±(0.05% of rdg + 0.05% of range) or less fluctuation per 10°C change Note, KpvsAu7Fe, PR20-40: ±(0.05% of rdg + 0.1% of range) or less Cu10 Ω system: ±(0.2% of range + 0.1°C) or less Excluding guaranteed reference junction accuracy
Insulation resistance:	Between input terminals and internal circuitry: 20 MΩ or greater (at 500 VDC)
Withstand voltage:	Universal, electromagnetic relay, 4-wire RTD/resistance: Between input terminals and internal circuitry: 3000 VAC, 1 minute Between analog input channels: 1000 VAC, 1 minute (excluding b terminal of universal input type) Low withstand voltage relay: Between input terminals and internal circuitry: 1500 VAC, 1 minute Between analog input channels: 400 VAC, 1 minute High-speed universal: Between input terminals and internal circuitry: 3000 V AC, 1 minute Between analog input channels: 3000 V AC, 1 minute
DC current (mA) input (-C1)	
Inputs:	10
Input types:	DC current (20 mA), standard current signal (4-20 mA)

Integral time:	1.67 ms/16.7 ms/20 ms/36.7 ms/100 ms
Input calculation:	Linear scaling, square root, differential calculations
Input range:	Refer to the Measurement range and accuracy tables.
Input resistance:	250 Ω
Allowable input voltage:	± 10 VDC
Allowable input current:	24 mA *50/60 Hz, peak value including the signal portion
Noise rejection ratio:	Normal mode: 50/60 Hz no rejection (integral time 1.67 ms), 40 dB or more (integral time 16.67 ms or more) Common mode: 80 dB or more (integral time 1.67 ms), 120 dB or more (integral time 16.67 ms or more)
Max. common mode voltage:	30 VACrms (50/60Hz) or 60 VDC (however, max. common mode noise voltage of measurement input is 250 VACrms)
Max. voltage between measurement input channels:	30 VACrms (50/60Hz) or 60 VDC (however, max. common mode noise voltage between measurement input channels is 250 VACrms)
Effects of ambient temperature:	Applies when integral time is 16.67 ms or more, ±(0.075% of rdg + 0.05% of range) or less fluctuation per 10°C change
Insulation resistance:	Between input terminals and internal circuitry: 20 MΩ or greater (at 500 VDC)
Withstand voltage:	Between input terminals and internal circuitry: 1500 VAC, 1 minute Between analog input channels: 1000 VAC, 1 minute

GX90XD Digital Input Module

Inputs:	16
Input format:	Open collector or non-voltage contact
Range types	DI, pulse (250Hz (The chattering filter: OFF), 125Hz (The chattering filter: ON), min. pulse width: 2 ms, requires the MATH (optional code /MT)).
ON/OFF detection:	Open collector: Voltage of 0.5 VDC or less when ON, leakage current of 0.5 mA or less when OFF Non-voltage contact: Contact resistance of 200 Ω or less when ON, 50 kΩ or more when OFF
Input calculation:	Linear scaling, differential calculations
Contact rating:	12 VDC, 20 mA or more
Input resistance:	Approx. 1 kΩ
No. of common:	2 (1 common per 8 channels)
Allowable input voltage:	10 V
Insulation resistance:	Between input terminals and internal circuitry: 20 MΩ or greater (at 500 VDC)
Withstand voltage:	Between input terminals and internal circuitry: 1500 VAC, 1 minute

GX90YD Digital Output Module

Outputs:	6
Output format:	Relay contact (c contact)
Rated load voltage:	30 VDC or 250 VAC or less
Max. load current:	3 A (DC)/3 A (AC), resistive load, each
Min. load voltage/current:	5 VDC/10 mA
No. of common:	6 (all outputs independent)
Insulation resistance:	Between output terminals and internal circuitry: 20 MΩ or greater (at 500 VDC)
Withstand voltage:	Between output terminals and internal circuitry: 3000 VAC, 1 minute

GX90WD Digital Input/output Module

● Digital input (DI) section

Inputs:	8
Input format:	Open collector or non-voltage contact
Range types:	DI, pulse (250Hz (The chattering filter: OFF), 125Hz (The chattering filter: ON), min. pulse width: 2 ms, requires the MATH (optional code /MT)).
ON/OFF detection:	Open collector: Voltage of 0.5 VDC or less when ON, leakage current of 0.5 mA or less when OFF Non-voltage contact: Contact resistance of 200 Ω or less when ON, 50 kΩ or more when OFF
Input calculation:	Linear scaling, differential calculations
Contact rating:	12 VDC, 20 mA or more
Input resistance:	Approx. 2.4 kΩ
No. of common:	1 (1 common per 8 channels)
Allowable input voltage:	10 V
Insulation resistance:	Between input terminals and internal circuitry: 20 MΩ or greater (at 500 VDC)
Withstand voltage:	Between input terminals and internal circuitry: 1500 VAC, 1 minute

● Digital output (DO) section

Outputs:	6
Output format:	Relay contact (c contact)
Rated load voltage:	150 VAC or less when connected to the main circuit (first-order power supply) 250 VAC or less when connected to a circuit derived from the main circuit (second-order power supply), or 30 VDC or less
Max. load current:	2 A (DC)/2 A (AC), resistive load, each
Min. load voltage/current:	5 VDC/10 mA
No. of common:	6 (all outputs independent)
Insulation resistance:	Between output terminals and internal circuitry: 20 MΩ or greater (at 500 VDC)
Withstand voltage:	Between output terminals and internal circuitry: 2700 VAC, 1 minute

GX90XP Pulse Input Module

Number of inputs:	10
Measurement interval:	100 ms (shortest)
Input type:	Contact (open collector, voltage-free contact), level (5 V logic)
Input range:	Up to 20 kHz 30 Hz when the chattering filter is in use (On)
Minimum detection pulse width:	25 μs 15 ms when the chattering filter is in use (On)
Measurement accuracy:	Count ± 1 pulse During integration, the following accuracies are added. Upon MATH start: +1 measuring period Upon MATH stop: -1 measuring period * Integration requires the math function (optional code /MT).
Chattering filter:	Removes chattering up to 5 ms (can be turned on/off on each channel)
Hysteresis width:	Approx. 0.2 V

Contact, transistor rating:	Contact: 15 V DC or higher and 30 mA or higher rating. Minimum applicable load current 1 mA or less. Transistor: With the following ratings: Vce>15 VDC, Ic>30 mA
Maximum input voltage:	± 10 V DC
Insulation resistance:	Between input terminals and internal circuitry: 20 MΩ or greater at 500 V DC
Withstand voltage:	Between input terminals and internal circuitry: 1500 V AC for 1 minute

Analog output module GX90YA

Number of outputs:	4 (isolated between channels)
Output type:	4 to 20mA or 0 to 20mA
Output update interval:	100 ms (shortest)
Load resistance:	600 Ω or less
Output accuracy:	± 0.1% of F.S. (1mA or more) (F.S.=20mA)

PID control module GX90UT

● Control loop	
Number of loops	2
● Analog input (measured input)	
Measured points:	2
Measurement type:	DC voltage (DCV)/standardized signal, TC/RTD, DI (LEVEL and non-voltage contact)/DC current (with external shunt resistance)
Scan (control) interval :	100 ms or 200 ms (system global setting)
● Analog output (control output/transmission output/sensor power supply)	
Outputs:	2
Output type:	Power supply for current, voltage pulse, or sensors. Current output: 4-20 mA or 0-20 mA Voltage pulse output: ON voltage = 12 VDC or more (load resistance 600 Ω or more), OFF voltage = 0.1 VDC or less Can be used as a sensor power supply (13.0-18.3 VDC)

● Digital input (switching the SP, operation mode, etc.)

Inputs:	8
Input format:	Non-voltage contact and open collector Contact rating: 12 VDC or more, 20 mA or more

● Digital output (of alarms, events, etc.)

Outputs:	8
Output format:	Open collector (sink type)
Output contact capacity:	Max 24 VDC, 50 mA
Withstand voltage/insulation resistance:	See PID control module general specifications (GS 04L51B01-31EN)
Terminal type:	M3 screw terminals
Weight:	Approximately 0.3kg

GX90EX Expansion Module

Connects via dedicated communication between main unit and subunits, and between subunits.

Communication speed:	10Base-T/100Base-TX (Auto)
Ports:	2
Connection cable:	STP cable, CAT5 or later
Connection between modules:	Cascade connection (no ring connection)
Communication range:	100 m

SMARTDAC+ GM common specifications

Standards supported

CSA:	CAN/CSA-C22.2 No. 61010-1, installation category II, pollution degree 2, CAN/CSA-C22.2 No. 61010-2-030 CAN/CSA-IEC 61010-2-201
UL:	UL 61010-1, UL 61010-2-030 (CSA NRTL/C) UL 61010-2-201 (CSA NRTL/C)
CE/EMC directives:	EN61326-1 compliance, Class A Table 2, EN61000-3-2 compliance, EN61000-3-3 compliance, EN55011 Class A Group 1
CE/Low voltage directive:	EN61010-1, EN 61010-2-030, Installation category II, pollution degree 2, Measurement category II, EN 61010-2-201 compliance
/C8 option R&TTE directive:	HEALTH&SAFETY EN61010-1 compliance EN61010-2-030 compliance Installation category II, pollution degree 2 Measurement category II EN62311 compliance
EMC	EN301 489-1 compliance EN301 489-17 compliance EN61326-1 compliance
SPECTRUM	EN300 328 compliance
EMC Regulatory Arrangement in Australia and New Zealand (RCM):	EN55011 Class A Group 1
Wireless communication standards of Australia and New Zealand (RCM) (optional code /C8):	AS/NZS4268, AS/NZS2772.2
KC marking:	Electromagnetic wave interference prevention standard, electromagnetic wave protection standard compliance
Environmental performance:	WEEE directive support
Wireless (Bluetooth):	Supports radio wave regulations of Japan, America, Canada, Europe (EU), Australia, New Zealand, China, and Korea.

Normal operating conditions

Ambient temperature:	-20 to 60°C If less, -20 to 50°C · When using the GX90YD, GX90WD, and GX90XA-T1 (electromagnetic relay type) · With the GM10/C8 (Bluetooth option)
Ambient humidity:	20 to 85% RH (no condensation)
Vibration:	5 ≤ f < 8.4 Hz amplitude 3.5 mm (peak) 8.4 ≤ f ≤ 160 Hz acceleration 9.8 m/s ² (or less)
Shock:	When ON, 98 m/s ² or less, 11 ms, 3 times in 6 directions (±X, ±Y, ±Z), (excluding GX90YD and GX90WD) When OFF, 500 m/s ² or less, approx. 10 ms, 3 times in 6 directions (±X, ±Y, ±Z)
Magnetic field:	400 A/m or less (DC and 50/60 Hz)

Standards supported



Main measurement range and accuracy*1

Universal, Current (mA) input, Low withstand voltage relay, electromagnetic relay, 4-wire RTD/resister type

Input type	Range	Measurement range	Measurement accuracy	
			A/D integration time: 16.7ms or more*2	A/D integration time: 1.67ms*3
DCV	20mV	-20.000 to 20.000 mV	±(0.05 % of rdg +12 µV)	±(0.1 % of rdg +40 µV)
	60mV	-60.00 to 60.00 mV	±(0.05 % of rdg +0.03 mV)	±(0.1 % of rdg +0.15 mV)
	200mV	-200.00 to 200.00 mV	±(0.05 % of rdg +0.03 mV)	±(0.1 % of rdg +0.4 mV)
	1V	-1.0000 to 1.0000 V	±(0.05 % of rdg +1.2 mV)	±(0.1 % of rdg +4 mV)
	2V	-2.0000 to 2.0000 V	±(0.05 % of rdg +1.2 mV)	±(0.1 % of rdg +4 mV)
	6V	-6.000 to 6.000 V	±(0.05 % of rdg +3 mV)	±(0.1 % of rdg +15 mV)
	20V	-20.000 to 20.000 V	±(0.05 % of rdg +3 mV)	±(0.1 % of rdg +40 mV)
	50V	-50.00 to 50.00 V	±(0.05 % of rdg +0.03 V)	±(0.1 % of rdg +0.15 V)
Standard signal	0.4-2V	0.3200 to 2.0800 V	±(0.05 % of rdg +1.2 mV)	±(0.1 % of rdg +4 mV)
	1-5V	0.800 to 5.200 V	±(0.05 % of rdg +3 mV)	±(0.1 % of rdg +15 mV)
DC current	0-20mA	0.000 to 20.000mA		
DC current (standard signal)	4-20mA	3.200 to 20.800mA	±(0.3 % of rdg +5 µA)	±(0.3 % of rdg +90 µA)
TC (Excluding RJC accuracy)	R	0.0 to 1760.0°C	±(0.15 % of rdg +1.0°C) However, R, S; 0.0 to 800.0°C: ± 2.2°C	±(0.2 % of rdg +6.0°C) However, R, S; 0.0 to 800.0°C: ± 7.6°C
	S	0.0 to 1760.0°C		
	B	0.0 to 1820.0°C	B; 400.0 to 800.0°C: ± 3.0°C Accuracy at less than 400.0°C not guaranteed	B; 400.0 to 800.0°C: ± 11.0°C Accuracy at less than 400.0°C not guaranteed
	K	-270.0 to 1370.0°C	±(0.15 % of rdg +0.7°C) However, -200.0 to 0.0°C: ±(0.35 % of rdg +0.7°C)	±(0.2 % of rdg +5.0°C) However, -200.0 to 0.0°C: ±(3 % of rdg +5.0°C)
		-200.0 to 500.0°C	Accuracy at less than -200.0°C not guaranteed	Accuracy at less than -200.0°C not guaranteed
	E	-270.0 to 800.0°C	±(0.15 % of rdg +0.5°C) However, -200.0 to 0.0°C: ±(0.35 % of rdg +0.5°C)	±(0.2 % of rdg +4.0°C) However, -200.0 to 0.0°C: ±(2 % of rdg +4.0°C)
	J	-200.0 to 1100.0°C	Accuracy at less than -200.0°C not guaranteed	Accuracy at less than -200.0°C not guaranteed
	T	-270.0 to 400.0°C	±(0.15 % of rdg +0.5°C) However, -200.0 to 0.0°C: ±(0.35 % of rdg +0.5°C)	±(0.2 % of rdg +2.5°C) However, -200.0 to 0.0°C: ±(2 % of rdg +2.5°C)
	N	-270.0 to 1300.0°C	Accuracy at less than -200.0°C not guaranteed	Accuracy at less than -200.0°C not guaranteed
	W	0.0 to 2315.0°C	±(0.15 % of rdg +1.5°C)	±(0.3 % of rdg +14.0°C) However, 1000.0°C or more: ±(0.8 % of rdg +9.0 °C)
	L	-200.0 to 900.0°C	±(0.15 % of rdg +0.5°C) Less than 0.0°C: ±(0.5 % of rdg +0.5°C)	±(0.2 % of rdg +4.0°C) Less than 0.0°C: ±(3 % of rdg +4.0°C)
	U	-200.0 to 400.0°C	±(0.15 % of rdg +0.5°C) Less than 0.0°C: ±(0.7 % of rdg +0.5°C)	±(0.2 % of rdg +2.5°C) Less than 0.0°C: ±(3 % of rdg +2.5°C)
	WRe3-25	0.0 to 2320.0°C	±(0.2 % of rdg +2.5°C)	± 18.0°C 2000.0°C or more: ± 0.9 % of rdg
RTD (Measured current: 1 mA)	Pt100	-200.0 to 850.0°C		
	JPt100	-150.00 to 150.00°C	±(0.05 % of rdg+0.3°C)	±(0.3 % of rdg+1.5°C)
4-wire RTD (Measured current: 1 mA)	Pt100	-200.0 to 850.0°C		
	JPt100	-150.00 to 150.00°C	±(0.05 % of rdg+0.3°C)	±(0.1 % of rdg+1.5°C)
4-wire RTD (Measured current: 0.25 mA)	Pt500	-200.0 to 850.0°C		
	Pt1000	-200.0 to 850.0°C	±(0.05 % of rdg+0.3°C)	±(0.1 % of rdg+1.5°C)
Resistance (4-wire)	20 Ω (Measured current: 1mA)	0.000 to 20.000 Ω	±(0.05 % of rdg+0.007 Ω)	±(0.1 % of rdg+0.025 Ω)
	200 Ω (Measured current: 1mA)	0.00 to 200.00 Ω	±(0.05 % of rdg+0.03 Ω)	±(0.1 % of rdg+0.15 Ω)
	2000 Ω (Measured current: 0.25mA)	0.0 to 2000.0 Ω	±(0.05 % of rdg+0.3 Ω)	±(0.1 % of rdg+1.0 Ω)
DI	Level		Threshold level (Vth=2.4 V) accuracy ± 0.1 V	
	Contact		1 kΩ or less: 1 (ON), 100 kΩ or more: 0 (OFF) (shunt capacitance 0.01 µF or less)	

High-speed universal type

Input type	Range	Measurement range	Measurement accuracy	
			Scan interval: 50 ms or more (Only the Values in [] apply when the scan interval is 50/100/200 ms)	Scan interval: 20 ms or less (Only the Values in [] apply when the scan interval is 1/2/5 ms)
DCV	20 mV	-20.000 to 20.000 mV	±(0.05 % of rdg+5[12]µV)	±(0.1 % of rdg+25[40]µV)
	60 mV	-60.00 to 60.00 mV	±(0.05 % of rdg+0.02 mV)	±(0.1 % of rdg+0.1 mV)
	200 mV	-200.00 to 200.00 mV	±(0.05 % of rdg+0.02[0.03] mV)	±(0.1 % of rdg+0.1[0.4] mV)
	1 V	-1.0000 to 1.0000 V	±(0.05 % of rdg+0.2 mV)	±(0.1 % of rdg+1.0 mV)
	2 V	-2.0000 to 2.0000 V	±(0.05 % of rdg+0.5[1.2] mV)	±(0.1 % of rdg+1.0[4.0] mV)
	6 V	-6.000 to 6.000 V	±(0.05 % of rdg+2 mV)	±(0.1 % of rdg+10 mV)
	20 V	-20.000 to 20.000 V	±(0.05 % of rdg+2[3] mV)	±(0.1 % of rdg+10[40] mV)
	50 V	-50.00 to 50.00 V	±(0.05 % of rdg+0.02 V)	±(0.1 % of rdg+0.10 V)
	100 V	-100.00 to 100.00 V	±(0.05 % of rdg+0.02 V)	±(0.1 % of rdg+0.10 V)
	Standard signal	0.4-2V	0.3200 to 2.0800 V	±(0.05 % of rdg+0.5[1.2] mV)
1-5V		0.800 to 5.200 V	±(0.05 % of rdg+2 mV)	±(0.1 % of rdg+10 mV)
TC*4 (Excluding RJC accuracy)	R	0.0 to 1760.0°C	±(0.05 % of rdg+1.0°C)	±(0.1 % of rdg+4.0[6.0]°C)
	S	0.0 to 1760.0°C		
	B	0.0 to 1820.0°C	B; 400.0 to 800.0°C: ± 1.5[3.0]°C Accuracy at less than 400.0°C not guaranteed	B; 400.0 to 800.0°C: ± 4.8[7.6]°C Accuracy at less than 400.0°C not guaranteed
	K	-270.0 to 1370.0°C	±(0.05 % of rdg+0.7°C) However, -200.0 to 0.0°C: ±(0.2 % of rdg+0.7°C)	±(0.1 % of rdg+3.5°C) However, -200.0 to 0.0°C: ±(2 % of rdg+3.5°C)
-200.0 to 500.0°C		Accuracy at less than -200.0°C not guaranteed	Accuracy at less than -200.0°C not guaranteed	

Input type	Range	Measurement range	Measurement accuracy	
			Scan interval: 50 ms or more (Only the Values in [] apply when the scan interval is 50/100/200 ms)	Scan interval: 20 ms or less (Only the Values in [] apply when the scan interval is 1/2/5 ms)
TC ^{*4} (Excluding RJC accuracy)	E	-270.0 to 800.0°C	±(0.05 % of rdg+0.5°C) However, -200.0 to 0.0°C: ±(0.2 % of rdg+0.5°C) Accuracy at less than -200.0°C not guaranteed	±(0.1 % of rdg+2.5°C) However, -200.0 to 0.0°C: ±(2 % of rdg+2.5°C) Accuracy at less than -200.0°C not guaranteed
	J	-200.0 to 1100.0°C	±(0.05 % of rdg+0.5°C) However, -200.0 to 0.0°C: ±(0.2 % of rdg+0.5°C) Accuracy at less than -200.0°C not guaranteed	±(0.1 % of rdg+2.5°C) However, -200.0 to 0.0°C: ±(2 % of rdg+2.5°C) Accuracy at less than -200.0°C not guaranteed
	T	-270.0 to 400.0°C	±(0.05 % of rdg+0.5°C) However, -200.0 to 0.0°C: ±(0.2 % of rdg+0.5°C) Accuracy at less than -200.0°C not guaranteed	±(0.1 % of rdg+2.5°C) However, -200.0 to 0.0°C: ±(2 % of rdg+2.5°C) Accuracy at less than -200.0°C not guaranteed
	N	-270.0 to 1300.0°C	±(0.05 % of rdg+0.7°C) However, -200.0 to 0.0°C: ±(0.5 % of rdg+0.7°C) Accuracy at less than -200.0°C not guaranteed	±(0.1 % of rdg+4.0°C) However, -200.0 to 0.0°C: ±(3.5 % of rdg+4.0°C) Accuracy at less than -200.0°C not guaranteed
	W	0.0 to 2315.0°C	±(0.05 % of rdg+1.0°C) Less than 1000.0°C: ± 0.15% of rdg	±(0.1 % of rdg+7.0°C) However, Less than 1000.0°C: ±(0.8 % of rdg)
	L	-200.0 to 900.0°C	±(0.05 % of rdg+0.5°C) Less than 0.0°C: ±(0.25 % of rdg+0.5°C)	±(0.1 % of rdg+2.5°C) Less than 0.0°C: ±(2 % of rdg+4.0°C)
	U	-200.0 to 400.0°C	±(0.05 % of rdg+0.5°C) Less than 0.0°C: ±(0.5 % of rdg+0.5°C)	±(0.1 % of rdg+2.5°C) Less than 0.0°C: ±(2 % of rdg+2.5°C)
	WRe3-25	0.0 to 2320.0°C	±(0.05 % of rdg+2.0°C) Less than 2000.0°C: ± 0.15% of rdg	±(0.1 % of rdg+8.0°C) Less than 200.0°C: 12.0°C Less than 2000.0°C: ±(0.1 % of rdg + 13.0°C)
RTD ^{*4} (Measured current: 1 mA)	Pt100	-200.0 to 850.0°C	±(0.05 % of rdg+0.3°C)	±(0.1 % of rdg+1.5°C)
		-150.00 to 150.00°C		
	JPt100	-200.0 to 550.0°C		
DI	Level	Threshold level (Vth=2.4 V) accuracy ± 0.1 V		
	Contact	100 kΩ or less: 1 (ON), 10 kΩ or more: 0 (OFF)		

*1 Reference operating conditions: 23 ± 2°C, 55 ± 10% RH, supply voltage 90-132, 180-264 VAC, supply frequency within 50/60 Hz ± 1%, warmup 30 minutes or more, no vibrations or other hindrances to performance.
Please inquire for modules with increased guaranteed accuracy specifications.
rdg: reading value

*2 10 channel mode with scan interval set to 500 ms or higher, or 2 channel mode

*3 10 channel mode with scan interval set to 100 ms or 200 ms

*4 For the measuring ranges and accuracy below, see the general specification (GS 04L53B00-01EN).

TC: KpvsAu7Fe, PLATINEL II, PR20-40, NiNiMo, W/WRe26, N(AWG14), XK GOST
RTD: Cu10 GE, Cu10 L&N, Cu10 WEED, Cu10 BAILEY, Cu10, Cu25, Cu53, Cu100, J263B, Ni100 (SAMA), Ni100 (DIN), Ni120, Pt25, Pt50, Pt200 WEED, Cu10 GOST, Cu50 GOST, Cu100 GOST, Pt46 GOST, Pt100 GOST

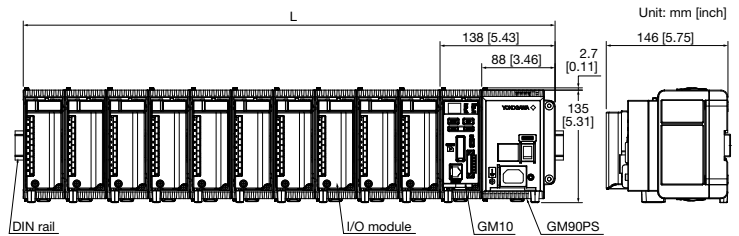

Connected modules	1	2	3	4	5	6	7	8	9	10	11
L (mm)	138 [5.43]	188 [7.40]	238 [9.37]	288 [11.34]	338 [13.31]	388 [15.28]	438 [17.24]	488 [19.21]	538 [21.18]	588 [23.15]	638 [25.12]

MODEL AND SUFFIX CODES

MODEL and SUFFIX Code (GM10)

Model	Suffix code	Optional code	Description
GM10			Data Acquisition Module for SMARTDAC+ GM
Type	-1		Standard (Max. measurement channels: 100 ch)
	-2		Large memory (Max. measurement channels: 500 ch)
Area	E		General (temp. unit: Cel, Deg F)
-		0	Always 0
Optional features		/AH	Aerospace heat treatment
		/AS	Advanced security function ^{*4}
		/BT	Multi-batch function ^{*5}
		/C3	RS-422/485
		/C8	Bluetooth
		/E1	EtherNet/IP communication (PLC communication protocol)
		/E2	WT communication ^{*1}
		/E3	OPC-UA sever
		/E4	SLMP communication (Mitsubishi PLC)
		/MT	Mathematical function (with report function) ^{*2*3}
	/MC	Communication channel function	
	/LG	Log scale	
	/PG	Program control function ^{*6}	

*1 Communication channel function (/MC option) must be specified at the same time with WT communication.

*2 Optional code /MT (MATH) required if using the GX90XD's or GX90WD's pulse input.

*3 Optional code /MT (MATH) required if using the GX90XP's pulse integration.

*4 When the Advanced Security function is ON the scan interval is 100 ms or more, and the Dual Interval function and PID modules are unavailable.

*5 When the Multibatch function is ON the scan interval is 500 ms or more, and the Dual Interval function is unavailable.

*6 Using the Program Control function requires the PID control module.

MODEL and SUFFIX Code (GM90PS)

Model	Suffix code	Description
GM90PS		Power Supply Module for SMARTDAC+ GM
Type	-1	Always -1
Area	N	General
Supply voltage	1	100 to 240 V AC
	2	12-28 VDC [*]
Power supply connection	D	Power inlet with UL/CSA cable
	F	Power inlet with VDE cable
	H	Power inlet with GB cable
	N	Power inlet with NBR cable
	Q	Power inlet with BS cable
	R	Power inlet with AS cable
	W	Screw terminal (without power cable)
-	0	Always 0

* Only W (Screw terminal (M4)) is available for the power supply connection.

MODEL and SUFFIX Code (GM90MB)

Model	Suffix code	Description
GM90MB		Module Base for SMARTDAC+ GM
-	-01	Always -01
Area	N	General
-	0	Always 0

MODEL and SUFFIX Code (GX90XA)

Model	Suffix Code			Description
GX90XA				Analog Input Module
Number of channels	-4			4 channels (-H0 type only)
	-6			6 channels (-R1 type only)
	-10			10 channels
Type	-C1			Current, scanner type (isolated between channels)
	-L1			Low withstand voltage DCV/TC/DI, scanner type (isolated between channels)
	-U2			Universal, Solid state relay scanner type (3-wire RTD b-terminal common)
	-T1			DCV/TC/DI, Electromagnetic relay scanner type (isolated between channels)
	-H0			High speed universal, individual A/D type (isolated between channels)
	-R1			4-wire RTD/resistance, scanner type (isolated between channels)
—		N		Always N
Terminal form			-3	Screw terminal (M3)
			-C	Clamp terminal*
Area			N	General

MODEL and SUFFIX Code (GX90XD)

Model	Suffix Code			Description
GX90XD				Digital Input Module
Number of channels	-16			16 channels
Type	-11			Open collector/Non-voltage, contact (shared common), Rated 5 VDC
—		N		Always N
Terminal form			-3	Screw terminal (M3)
			-C	Clamp terminal
Area			N	General

MODEL and SUFFIX Code (GX90YD)

Model	Suffix code			Description
GX90YD				Digital Output Module
Number of channels	-06			6 channels
Type	-11			Relay, SPDT(NO-C-NC)
—		N		Always N
Terminal form			-3	Screw terminal (M3)
Area			N	General

MODEL and SUFFIX Code (GX90WD)

Model	Suffix code			Description
GX90WD				Digital Input/Output Module
Number of channels	-0806			8 channel DIs, 6 channel DOs
Type	-01			Input: Open collector/non-voltage contact (shared common), rated 5 VDC Output: Relay, SPDT (NO-C-NC)
—		N		Always N
Terminal form			-3	Screw terminal (M3)
Area			N	General

MODEL and SUFFIX Code (GX90XP)

Model	Suffix code			Description
GX90XP				Pulse Input Module
Number of channels	-10			10 channels
Type	-11			DC voltage/open collector/non-voltage contact (shared common), rated 5 VDC
—		N		Always N
Terminal form			-3	Screw terminal (M3)
			-C	Clamp terminal
Area			N	General

MODEL and SUFFIX Code (GX90EX)

Model	Suffix code			Description
GX90EX				I/O Expansion Module
Port	-02			2 ports
Type		-TP1		Twisted pair cable
—			N	Always N
Area			-N	General

MODEL and SUFFIX Code (GX90YA)

Model	Suffix code			Description
GX90YA				Analog output module
Number of channels	-04			4channels
Type		-C1		Current output (Isolated between channels)
—			N	Always N
Terminal form			-3	Screw terminal (M3)
			-C	Clamp terminal
Area			N	General

MODEL and SUFFIX Code (GX90UT)

Model	Suffix Code			Description
GX90UT				PID control module
Number of loops	-02			2 loops
Type		-11		8 DIs, 8 DOs
—			N	Always N
Terminal form			-3	Screw terminals (M3)
Area			N	General

Standard Accessories

Model	Product	Qty
GM10	SD memory card (1GB)	1
	Connector cover	1
GM90PS	Power cable (depends on the suffix code of the power supply connection)	1
	Interconnect screw (M3)	4
GM90MB	Interconnect screw (M3)	4

Optional Accessories (Sold Separately)

Product	Part Number/Model
SD memory card (1GB)	773001
Shunt resistor for screw terminal (M3) (250 Ω ± 0.1%)	415940
Shunt resistor for screw terminal (M3) (100 Ω ± 0.1%)	415941
Shunt resistor for screw terminal (M3) (10 Ω ± 0.1%)	415942
Shunt resistor for clamp terminal (250 Ω ± 0.1%)	438920
Shunt resistor for clamp terminal (100 Ω ± 0.1%)	438921
Shunt resistor for clamp terminal (10 Ω ± 0.1%)	438922
Dummy cover	B8740CZ
Validation Documents (For /AS option)	773230

Application Software (Sold Separately)

Model	Description	OS
GA10	Data Logging Software	Windows 7/8.1/10 Windows Server 2008/2012/2016

● Calibration certificate (sold separately)

A calibration certificate for specific analog input modules.

● Test certificate (QIC, sold separately)

A QIC for specific data acquisition modules, power supply modules, module bases, or I/O modules.

● User's Manual

Product user's manuals can be downloaded or viewed at the following URL. URL: www.smartdacplus.com/manual/en/

Configuration example

(with a supply voltage of 100-240 VAC, power inlet, universal input, and clamp terminal)

Single-unit configuration example

30 ch (analog input)

GM10-1E0	x 1
GM90PS-1N1D0	x 1
GX90XA-10-U2N-CN	x 3
GM90MB-01N0	x 4



60ch (analog input)

GM10-1E0	x 1
GM90PS-1N1D0	x 1
GX90XA-10-U2N-CN	x 6
GM90MB-01N0	x 7



100ch (analog input)

GM10-1E0	x 1
GM90PS-1N1D0	x 1
GX90XA-10-U2N-CN	x 10
GM90MB-01N0	x 11



Multi-unit configuration example

120ch (analog input)

GM10-2E0	x 1
GM90PS-1N1D0	x 2
GX90XA-10-U2N-CN	x 12
GX90EX-02-TP1N-N	x 2
GM90MB-01N0	x 15



300ch (analog input)

GM10-2E0	x 1
GM90PS-1N1D0	x 5
GX90XA-10-U2N-CN	x 30
GX90EX-02-TP1N-N	x 5
GM90MB-01N0	x 36



420ch (analog input)

GM10-2E0	x 1
GM90PS-1N1D0	x 7
GX90XA-10-U2N-CN	x 42
GX90EX-02-TP1N-N	x 7
GM90MB-01N0	x 50



Paperless recorder GX/GP

With the touch panel, reliability meets user empowerment in an expanding range of applications.



Modules and functions are interchangeable with the GM.

Intuitive user interface

- Easily move through screens like on a smart device to quickly access past data
- A variety of screen displays come standard, such as trend, numeric, and bar graph
- Custom display function (/CG option) lets you build screens any way you like
- At a phenomenon of interest, write a message with a single touch

Highly customizable architecture

- Modular I/O configuration for easy expandability

- Up to 450 ch of measurement (actual input)

- Many I/O modules available to support a wide variety of applications

A full range of network functions and software

- Like the GM, a full range of networking functions are available including Modbus and EtherNet/IP.

Solid hardware and high security

- High precision measurement in a durable unit
- Reliably saves measured data
- Supports 21 CFR Part 11
- With enhanced security, safely sends/receives data

Data Logging Software GA10 (sold separately)

Centrally acquire data from multiple devices on a PC

GA10 is a PC based software package that acquires real time data from SMARTDAC+ data acquisition systems and other devices connected to a network. Connected PCs can monitor real time and historical data, which can be stored on a PC harddrive or centrally on a network drive.

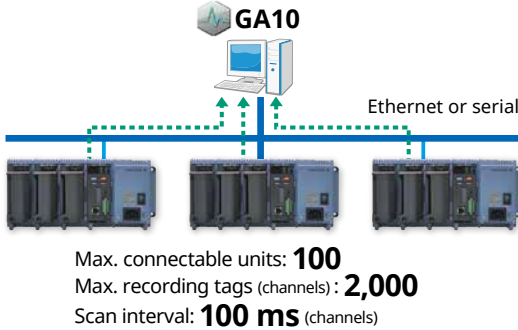

Compatible with other models in addition to the GM!



MX/MW series



WT series (power analyzers)

Supports many other models. For details, see the GA10 catalog.

Aggregate data for monitoring!



Easy to read screen layouts provide operator friendly real time monitoring.

- Group channels any way you like
- Play back data up to recording start, even during measurement
- Instantly recognize alarms (in red)

Save the data all together!



Binary



Excel

Data is stored in a binary tamper proof format preventing unauthorized access. Data can also be exported to excel format for data manipulation and analysis.

Application example

Data monitoring in manufacturing sites

Monitor factory data from the office.
 You can also add clients and share data across multiple PCs.

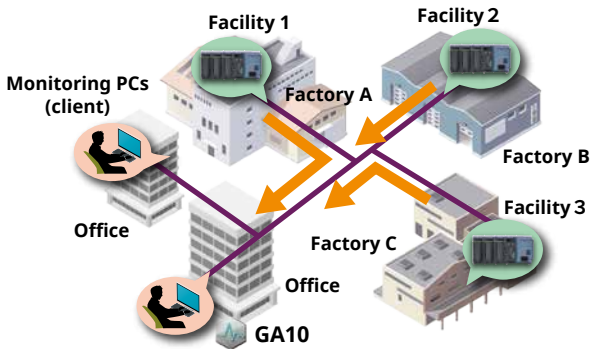

Effect: No more moving around large factories to do work!

Recording data from multiple equipments

Saves testing/manufacturing equipment data on a PC. In addition to simultaneous acquisition, you can acquire data from different equipment at different timing (multilogging).

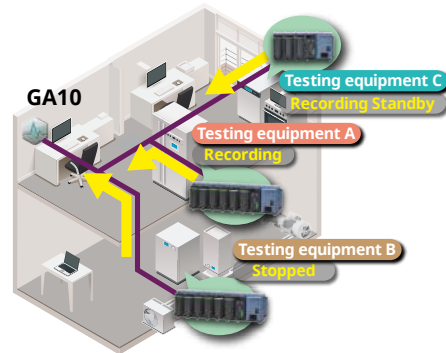

Effect: Manage all data on the PC, one set of equipment at a time!

SMARTDAC+ and SMARTDACPLUS are registered trademarks of Yokogawa Electric Corporation.
 Microsoft and Windows are registered trademarks or trademarks of Microsoft Corporation in the United States and other countries.
 Other company names and product names appearing in this document are registered trademarks or trademarks of their respective holders.

NOTICE



Before operating the product, read the instruction manual thoroughly for proper and safe operation.

YOKOGAWA ELECTRIC CORPORATION

Control Instruments Sales Division
 E-mail: ns@cs.jp.yokogawa.com

<http://www.yokogawa.com/>

YOKOGAWA CORPORATION OF AMERICA

YOKOGAWA EUROPE B.V.

<http://www.yokogawa.com/us/>

<http://www.yokogawa.com/eu/>

YOKOGAWA ENGINEERING ASIA PTE. LTD.

<http://www.yokogawa.com/sg/>

Sign up for our free e-mail newsletter
www.yokogawa.com/ns/

Subject to change without notice
 All Rights Reserved. Copyright © 2014, Yokogawa Electric Corporation

AZ-S-2E
 Printed in Japan, 705(AZ) [Ed:03/d]