



**INNOVATIVE  
MONITORING  
SOLUTIONS**

[www.fourtec.com](http://www.fourtec.com)



**FACTORIES**  
Monitoring product quality throughout the entire manufacturing cycle



**TESTING STANDARDS**  
Ensuring quality control and compliance with safety standards



**RESEARCH & DEVELOPMENT**  
Academic and industrial laboratory research measuring multiple parameters



**MILITARY**  
Storage, equipment maintenance, machinery and production testing



**AUTOMOTIVE**  
Compatibility tests, electronics, control panels and engine operating temperatures

# DaqPRO Solution

ALL IN ONE SOLUTION FOR DATA LOGGING AND ANALYSIS

## User Guide

including DaqLab



# DaqPRO

## *User Guide*

Tenth Edition

First Print

April 2010

© fourtec – Fourier Technologies Ltd.



# Contents

Introduction .....	1
Chapter 1 DaqPRO.....	3
1.1. General .....	3
1.1.1. DaqPRO: System Contents.....	3
1.1.2. External Connections .....	4
1.1.3. Sensor Types and Connections .....	5
1.1.4. User Defined Sensors .....	7
1.1.5. Alarms.....	8
1.1.6. Alarm Output.....	8
1.1.7. Sensor Calibration.....	9
1.1.8. Serial Number and Comment.....	9
1.1.9. Battery.....	9
1.1.10. Mains Adaptor.....	9
1.2. Standalone Operation.....	10
1.2.1. Front Panel Layout.....	10
1.2.2. Quick-Start.....	11
1.2.3. Working with the DaqPRO Menus.....	15
1. Turning DaqPRO On and Off.....	15
2. Main Menu Display .....	15
3. Menu Buttons .....	16
4. Menu Icons and Commands.....	16
1.2.4. Graphic Display.....	18
1. The Cursor.....	19
2. Zooming.....	19
1.2.5. Load the Last Setup .....	20
1.2.6. Configuring your DaqPRO.....	20
1. Temperature Compensation.....	21
2. Averaging Points .....	21
3. Temperature Units.....	21
4. Clear Memory .....	21
5. Screen Contrast.....	21
1.2.7. Internal Clock and Calendar.....	22
1.2.8. Clearing the Memory .....	22
1.2.9. Choosing the Right Setup .....	22
1.2.10. Programming Rules and Limitations .....	24

Chapter 2	Working with DaqLab .....	26
2.1.	Installing the Software .....	26
2.1.1.	System Requirements .....	26
2.1.2.	Installation .....	26
2.2.	Overview .....	28
2.2.1.	DaqLab On-screen Layout .....	28
2.2.2.	Working with Projects .....	28
2.2.3.	DaqLab Window Layout .....	29
2.3.	Getting Started .....	30
2.3.1.	Setting up a Recording Session .....	30
1.	Prepare DaqPRO .....	30
2.	Setup the DaqPRO .....	30
3.	Start Recording .....	30
2.3.2.	Data Recording Options .....	31
1.	Single Measurement .....	31
2.	Replace .....	31
3.	Add .....	31
2.3.3.	Downloading Data .....	31
2.3.4.	Saving Data .....	32
2.3.5.	Opening a File .....	33
2.3.6.	Creating a New Project .....	33
2.3.7.	Import Data .....	33
2.3.8.	Date Format Settings .....	34
2.3.9.	Print .....	35
1.	Print a Graph .....	35
2.	Print a Table .....	35
2.4.	Viewing the Data .....	36
2.4.1.	Display Options .....	36
2.4.2.	Graph Display .....	36
1.	Split Graph View .....	36
2.	The Cursor .....	37
3.	Zooming .....	38
4.	Panning .....	39
5.	Edit the Graph .....	39
6.	Display Alarm Levels .....	40
7.	Format the Graph .....	41
8.	Change the Graph's Units and its Number Format .....	41
9.	Add a Graph to the Project .....	41
2.4.3.	The Table Display .....	42

	1. Formatting the Table .....	42
2.4.4.	Meters .....	43
2.4.5.	Data Map .....	43
	1. Control the Display with the Data Map .....	44
	2. Understanding Data Map Icons .....	44
2.4.6.	Exporting Data to Excel .....	45
	1. Export all Open Data Sets .....	45
	2. Exporting over 64,000 Samples to Excel .....	45
	3. Export File Settings .....	46
2.4.7.	Copying the Graph as a Picture .....	46
2.5.	Programming DaqPRO .....	47
2.5.1.	Setup .....	47
	1. Quick Setup .....	47
	2. Alarm Setup .....	49
	3. Temperature Compensation .....	50
	4. Averaging .....	50
	5. Battery Level .....	50
	6. Presetting the Display .....	50
	7. Preset the Graph's X-axis .....	51
	8. Triggering .....	52
2.5.2.	Starting Recording .....	53
2.5.3.	Stopping Recording .....	53
2.5.4.	Clearing DaqPRO's Memory .....	53
2.5.5.	Adding a Comment to DaqPRO .....	53
2.5.6.	Edit DaqPRO's Notes .....	54
2.5.7.	Temperature Units .....	55
2.5.8.	Calibrating the Sensors .....	55
	1. Introduction to <i>DaqPRO</i> Calibration .....	55
	2. Working with the factorydefaults.daq File .....	55
	3. Saving the Calibration Settings Manually .....	56
	4. Calibration Options .....	57
	5. Calibration Password .....	58
	6. Calibration Procedure .....	59
2.5.9.	Defining a Custom Sensor .....	65
2.5.10.	Communication Setup .....	66
2.6.	Analyzing the Data .....	67
2.6.1.	Reading Data Point Coordinates .....	67
2.6.2.	Reading the Difference between two Coordinate Values .....	67
2.6.3.	Working with the Analysis Tools .....	67

2.6.4.	Smoothing.....	67
2.6.5.	Statistics.....	68
2.6.6.	Most Common Analysis Functions.....	68
	1. Linear Fit.....	68
	2. Derivative.....	69
	3. Integral.....	69
2.6.7.	The Analysis Wizard.....	69
	1. Using the Analysis Wizard.....	69
	2. Curve Fit.....	70
	3. Averaging.....	71
	4. Functions.....	72
2.6.8.	Available Analysis Tools.....	73
	1. Curve Fit.....	73
	2. Averaging.....	73
	3. Functions.....	74
2.7.	Special Tools.....	78
2.7.1.	Crop Tool.....	78
	1. To Trim all Data Up to a Point.....	78
	2. To Trim all Data Outside a Selected Range.....	78
2.8.	Toolbar Buttons.....	79
2.8.1.	Main (Upper) Toolbar.....	79
2.8.2.	Graph Toolbar.....	80
Chapter 3	Troubleshooting Guide.....	82
Chapter 4	Specifications.....	84
Appendix: Figures	.....	88
Appendix: Simplified Measurement Circuits	.....	89
Index	.....	91

# Introduction

*DaqPRO* is an eight-channel portable data acquisition and logging system with graphic display and built-in analysis functions.

*DaqPRO* is battery operated and is capable of sampling, processing and displaying measurements without connecting to a computer. Designed to serve the needs of professional data loggers, *DaqPRO* is a professional, cost-effective, compact and stand-alone data logging system that can be used with a wide variety of applications. This 16-bit, high-resolution, eight-channel data logger offers the professional graphic displays and analysis functions for measuring voltage, current and temperature in real-time.

With its high resolution and fast Analog to Digital converter (ADC), *DaqPRO* meets the majority of data logging requirements in most industrial applications. Its unique ability to display measured values and analyze them in real-time on a graphical interface minimizes the need to download collected data to a computer for further analysis.

Every *DaqPRO* unit is embedded with a unique serial number and can be loaded with a descriptive comment for safe identification.

*DaqPRO* 5300 includes eight input channels for measuring voltage, current, temperature and pulses. Selectable ranges for each input are 0-24 mA, 0-50 mV, 0-10 V, a large variety of NTC, PT-100 and thermocouple temperature sensors including internal temperature, pulse counter, frequency meter and up to 20 user defined sensors. The inputs use pluggable screw terminal blocks for easy connection.

An internal clock and calendar keep tracks of the time and date of every sample measured.

*DaqPRO* can automatically activate external alarm events when data is outside a specified range.

*DaqPRO* is very easy to use because all its functions are broken down into an 8-icon menu, its four buttons can browse every menu and execute any of the commands.

A rechargeable battery powers the data logger, which shuts off automatically after 15 minutes have passed since the time of the last data recording, the time the last button was pressed, or the time the last communication was made with the PC.

The *DaqPRO* system also comes with the powerful DaqLab software. When the *DaqPRO* is connected to a PC, live displays can be viewed at rates of up to 100/s, and automatic downloads can be carried out at higher rates. The WINDOWS™ based software can display the data in graphs, tables or meters, can analyze data with various mathematical tools, or export data to a spreadsheet.

DaqLab also enables you to setup *DaqPRO* and to send advanced commands such as alarm settings, triggering conditions and text notes.

This manual is divided into three sections:

- The first section is dedicated to the data logger itself. Topics include: Connecting sensors, configuration through the data logger keypad, and using the LCD graphic display to take measurements when working offline.
- The second section gives a comprehensive overview of the DaqLab software. Topics include: How to download data from the data logger to a PC, analyzing the data both graphically and mathematically and using the DaqLab software to program the data logger when working online.
- The third and last section contains hardware specifications and a comprehensive troubleshooting guide that gives answers to common questions.



# Chapter 1

## *DaqPRO*

This section will focus on the *DaqPRO*'s data collection device – the data logger; and includes:

- Operating the *DaqPRO* keypad
- Setting up *DaqPRO*
- Connecting sensors to *DaqPRO*
- Connecting *DaqPRO* to your PC
- Conducting a logging session

### 1.1. General

#### 1.1.1. *DaqPRO: System Contents*

- DaqPRO data logger
- USB communication cable
- AC-DC adaptor
- DaqLab software installation CD
- User guide
- Carrying case

### 1.1.2. External Connections

1. Sensor Inputs/Alarm output

8<sup>th</sup>  
input/output

1<sup>st</sup>  
input

2. PC USB connection socket

3. Power input (DC 9 – 12V)



Figure 1: *DaqPRO* external connections

1. **Sensor inputs/alarm output** – Pluggable screw terminal block (marked Input -1 to Input -8 from right to left). All eight inputs can be used simultaneously.

If you are using one sensor, connect it to input 1. If you are using two sensors connect them to inputs 1 and 2, and so on.

I/O-8 (Input/Output-8) serves either as an input or as alarm output.

To connect a sensor to the *DaqPRO* unplug the screw terminal, connect the sensor's wires to the terminals, and then plug the terminal back to the corresponding socket on the input block.

2. **Computer USB communication socket** – Use this socket to connect *DaqPRO* to a computer. Connect the USB Type B plug (square plug) of the supplied communication cable to the *DaqPRO* and the USB Type A plug (flat plug) to the computer (refer to page 27 for USB driver installation).
3. **External DC power supply socket** – Plug in an AC/DC 9 - 12V adaptor whenever you want to save battery power, or to charge the battery when necessary. Connecting external power to the *DaqPRO* automatically charges the internal battery. The adaptor should meet the required specifications (also refer to section 1.1.10 on page 9).

### 1.1.3. *Sensor Types and Connections*

Each of the 8 input channels of *DaqPRO* is multi-purpose and can be individually configured to any of the following types and ranges:

Sensor	Type	Range
Current		0 – 24mA
Frequency (input 1 only)		20 to 4000Hz
Pulse counter (input 1 only)		0 to 65,000 pulses
Temperature	Internal	-25 to 70 °C
Temperature	NTC 10K	-25 to 150 °C
Temperature	NTC 100K	-25 to 150 °C
Temperature	PT-100 2-wire	-200 to 400 °C
Temperature	PT-100 3-wire	-200 to 400 °C
Temperature	Thermocouple J	-200 to 1200 °C
Temperature	Thermocouple K	-250 to 1200 °C
Temperature	Thermocouple T	-200 to 400 °C
Voltage		0 – 10V
Voltage		0 - 50mV
User defined	Up to 20 types	0 – 10V or 0 – 24mA

Connect the sensor to the terminal block at the top of *DaqPRO*:

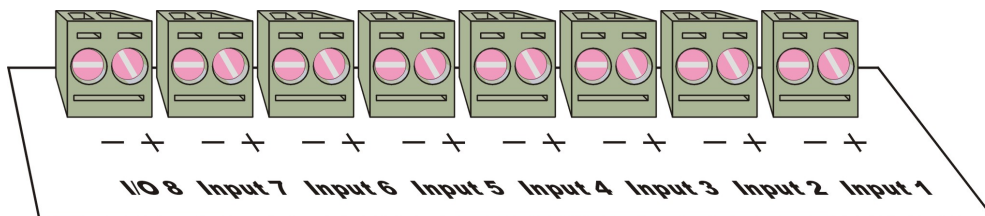

**Figure 2: *DaqPRO*'s inputs block terminal**

Sensors must be added successively, starting with input-1. If a single sensor is used it must be connected to Input-1. If two sensors are used, they must be connected to Input-1 and Input-2 and so on.

### **Alarm Output**

I/O-8 (Input/Output-8) serves either as an input or as alarm output.

### **Polarity**

Current, voltage, thermocouples and user defined sensors have distinct polarity. Be careful to connect them in the right polarity.

### **Frequency/Pulse Counter**

Connect the signal wires to I/O-8 screw terminals, and select **Frequency** or **Pulse counter** for **Input 1** from the Setup menu. Inputs 2 to 7 are still available for other sensors.

The Frequency/pulse counter is optically isolated from the internal circuitry and can simultaneously measure a signal source, together with another input.

### **3-wire PT 100**

You have to use two inputs to connect a 3 wire PT 100. You can connect one 3-wire PT 100 to input-1 and input-5, and/or inputs 2 and 6, and/or inputs 3 and 7 and/or inputs 4 and 8.

Connect the single wire to the plus (+) terminal of the first input and the common end wires to the minus (-) terminals of both the inputs.

See Figure 3 for the wiring configuration of a 3-wire PT 100 connected to input-1 and input-5:

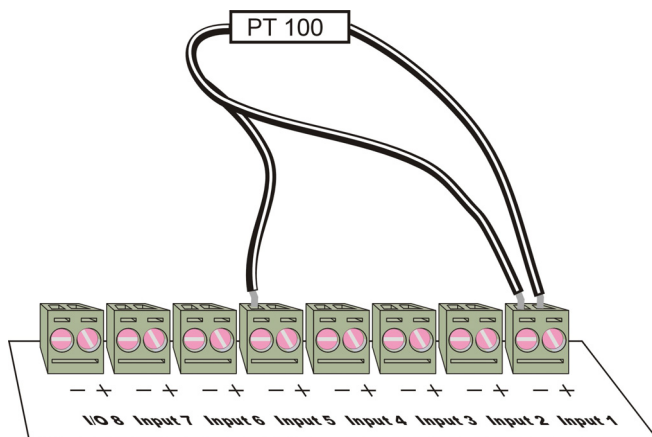

**Figure 3: Connecting 3-wire PT 100**

When working with a 3-wire PT 100, inputs 5 to 8 are not available and you can connect up to 4 sensors.

### **Sensor Mismatch**

After logging begins, *DaqPRO* checks if the sensor type assigned to each channel matches the attached sensor. If there is a mismatch, *DaqPRO* disconnects the corresponding input and displays a warning message: *Illegal sensor* (refer to the *Troubleshooting Guide* on page 82 for details).

### **1.1.4. User Defined Sensors**

*DaqPRO* provides a simple and straightforward tool for defining up to 20 custom sensors. Almost any 0 – 10V and 0 – 24mA sensor or transducer is accepted by *DaqPRO* and its electrical units are automatically scaled to meaningful user-defined engineering units.

The sensor definitions are stored in *DaqPRO*'s memory and are added to the sensors list. The sensor's readings are displayed in the user defined units both on *DaqPRO*'s LCD screen and DaqLab software.

To learn how to define custom sensors refer to section 0 on page 55.

For further manipulating sensors readings use the Analysis wizard (refer to page 69).

### 1.1.5. Alarms

Users can define minimum and maximum alarm levels for each input individually.

*DaqPRO* places a small alarm icon  next to the corresponding input readings and can switch alarm output if either level is breached.

To display alarm warnings in real-time *DaqPRO* must be in numeric display mode (see page 14).

To learn how to enter alarm levels and to activate alarm output, see section 2.5.1.2 on page 49.

### 1.1.6. Alarm Output

*DaqPRO* can trigger an external event (e.g. sound alarm, warning light or oven).

Connect the external current loop to the screw terminals of I/O-8. Be careful to connect the external power supply in the right polarity (see Figure 4 below).

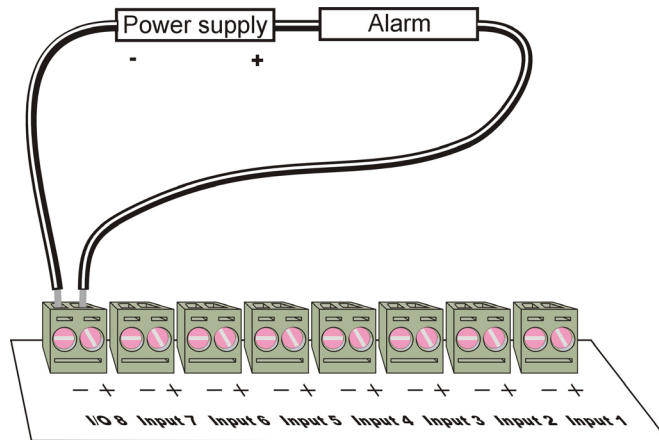

**Figure 4: Connecting external alarm device**

The alarm output is analogous to electrical switch. In OFF position the terminals of I/O-8 are disconnected. In ON position they are shortened.

If an alarm output is selected this input/output is set to OFF position. When any active alarm level is exceeded the output is set to ON. All active alarms must be false to reset the output to OFF position.

The maximum switch load is 50mA, 5V. The output is protected by 50mA reset-able fuse. For higher loads use a relay.

To learn how to enter alarm levels and to activate alarm output, refer to section 2.5.1.2 on page 49.

### 1.1.7. *Sensor Calibration*

*DaqPRO* ships fully calibrated. However, further calibration can be applied via DaqLab. The calibration parameters are sent to *DaqPRO* and stored in its memory. Refer to page 55 for calibration instructions.

### 1.1.8. *Serial Number and Comment*

Every *DaqPRO* unit is embedded with a unique serial number and can be loaded with a descriptive comment to identify its task and location.

To add or edit the comment connect *DaqPRO* to the computer and use DaqLab software (refer to page 53).

Every time data is transferred to the computer it is labeled both with *DaqPRO*'s serial number and comment and then displayed in the graph title.

The serial number is marked on the back of the product. To view its comment, select **System information** from *DaqPRO*'s main menu.

### 1.1.9. *Battery*

*DaqPRO* is equipped with a 7.2V Ni-MH rechargeable battery. Before you first start working with *DaqPRO*, charge the unit for 10 to 12 hours while it is turned off. Battery life is approximately 25 hours between charges.

If the data logger's main battery runs out, the internal 3V Lithium battery backs up the memory, so no data will be lost. The Lithium battery also keeps the internal clock and calendar running.

If the lithium battery is removed from the *DaqPRO*, the unit's calibration settings will be lost. See page 55 for more information.

**Note:** Before storing the data logger make sure you have unplugged all the sensors and pressed the OFF key.

### 1.1.10. *Mains Adaptor*

The Mains adaptor (AC/DC adaptor) converts mains power (from a wall outlet) to a voltage suitable to *DaqPRO*.

- Output: Capacitor filtered 9 to 12 VDC, 400mA
- Female plug, center Negative

## 1.2. Standalone Operation

One way to program the *DaqPRO* is to use its keypad and screen (the other way is to use the DaqLab software – refer to page 47). The keypad allows us to set all the parameters for data collection, while the LCD screen displays the setting values.

### 1.2.1. Front Panel Layout

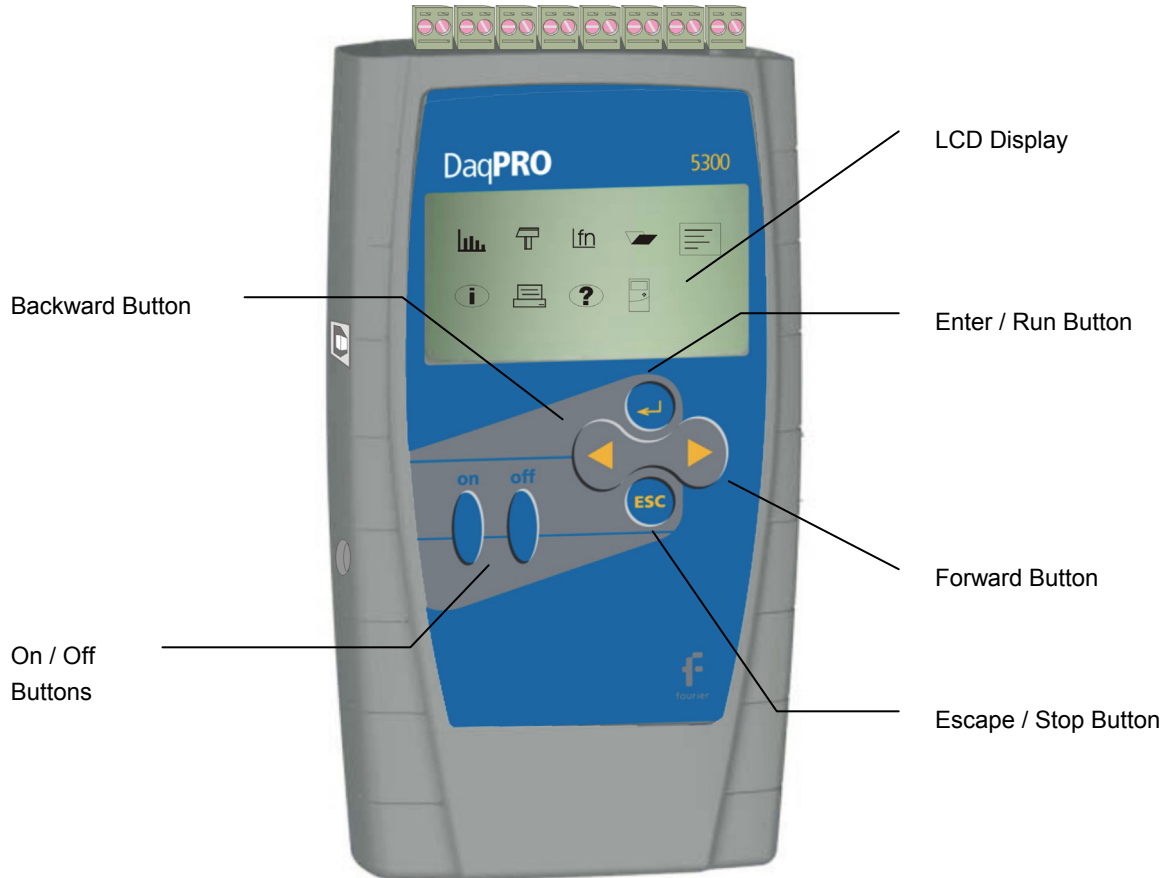

Figure 5: *DaqPRO* front panel



## 1.2.2. Quick-Start

Before you first use *DaqPRO*, charge the unit for 10 to 12 hours while it is turned off.

### 1. Turn on *DaqPRO*

Press the **On** button. You will see the initialization screen. *DaqPRO* performs a brief self-check and displays its status, including operating mode. It then loads the last setup you used (refer to page 20). If you need a new setup wait until you see the Main Menu screen:



### 2. Connect the Sensors

Start with the first input on the right.

**Note:** Sensors must be added successively, starting with input 1. If a single sensor is used it must be connected to Input 1. If two sensors are used, they must be connected to Input 1 and Input 2.

Refer to *Sensors Types and Connections* on page 5 for more details.

### 3. Identify the Sensors

You must tell *DaqPRO* what type of sensor is connected to each input.

- a. In the Main Menu screen, use the **Forward**  **arrow** buttons to select the



**setup** menu icon



- b. Press the **Enter** button  to enter the setup menu:

```
→ In - 1 Voltage 0-10V
   In - 2 Empty
   In - 3 Empty
   In - 4 Empty

   RATE = Every sec
   SAMPLES = 500
   DISPLAY = numeric
```

- c. Use the **Forward**  and **Backward**  arrow buttons to select the sensor in input 1 and then press the **Enter** button . The arrow indicator will move to the second input.
- d. Repeat this procedure with all the sensors you plugged in.
- e. After the fourth sensor has been selected, the screen will list the next 4 sensors:

```
→ In - 5 Empty
   In - 6 Empty
   In - 7 Empty
   In - 8 Empty

   RATE = Every sec
   SAMPLES = 500
   DISPLAY = numeric
```

You can press the **Enter** button in the last input if you want to go back to the first input.

- f. When you've finished selecting the sensors press the **Escape** button . The arrow indicator will point to the Rate command.

#### 4. Select Rate

- a. Use the **Forward**  and **Backward**  arrow buttons to select the desired rate, then press the **Enter** button .

```
In - 1 Current 0-24mA
In - 2 NTC 10K
In - 3 Empty
In - 4 Empty

→ RATE = Every 10 sec
   SAMPLES = 500
   DISPLAY = numeric
```

*DaqPRO* automatically switches to the next step in the setup process and the arrow moves to the *samples* row.

#### 5. Select Total Number of Samples

- a. Use the **Forward**  and **Backward**  arrow buttons to select the number of samples, then press the **Enter** button .

```
In - 1 Current 0-240 mA
In - 2 Thermocouple T
In - 3 Empty
In - 4 Empty

→ RATE = Every sec
   SAMPLES = 10,000
   DISPLAY = numeric
```

## 6. Choose Display



- a. Use the **Forward**  and **Backward**  arrow buttons to select the type of display, then press the **Enter** button .

```
In - 1   Current 0-240 mA
In - 2   Thermocouple T
In - 3   Empty
In - 4   Empty

RATE = Every sec
SAMPLES = 10,000
→ DISPLAY = numeric
```

**Note:** When you turn the *DaqPRO* off it will save the setup for the next session.

## 7. Start Recording

- a. After selecting the Display, press the **Forward** arrow button  to start recording.
- Or**
- b. Press the **Enter** button if you want to go back to the first item (Rate).
- c. You can stop recording at any time by pressing the **Escape** button .

### 1.2.3. Working with the DaqPRO Menus

#### 1. Turning DaqPRO On and Off

**On** Turn *DaqPRO* on

**Off** Turn *DaqPRO* off

**Note:** Pressing OFF will not erase the sample memory. The data stored in the memory will be kept for up to 5 years.

#### 2. Main Menu Display

When turned on, *DaqPRO* opens with a system information window and then displays the main menu:

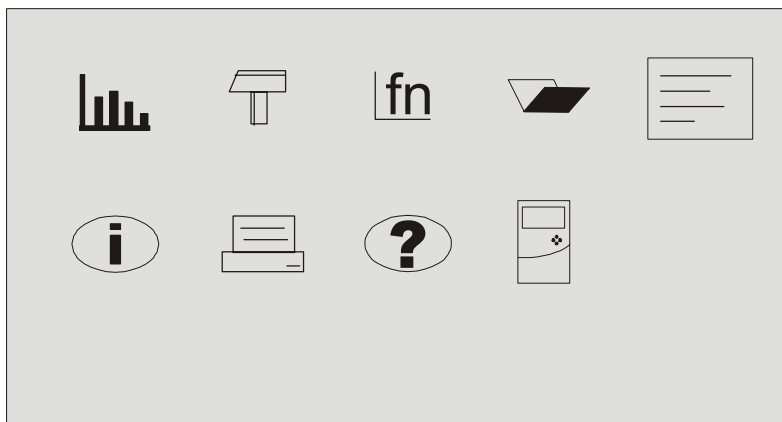

*DaqPRO* has 9 menus. Use the Forward or Backward **Arrow** buttons to highlight a menu and press the **Enter** button to select it. Then use the **Arrow** buttons to scan the options. Press the **Enter** button to select an option. The *DaqPRO* automatically executes the command.

### 3. Menu Buttons



**Forward**

Move to the next menu or to the next menu options



**Backward**

Move to the previous menu or menu options



**Enter (Start)**

Enter the selected menu or select the current menu option and move to the next menu command or start recording



**Escape (Stop)**

Return to the main menu or stop recording

### 4. Menu Icons and Commands

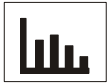

**Start**

Start recording

Press the **Enter** button to start recording

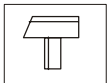

**Setup**

Setup *DaqPRO* in 4 steps:

**Rate** – Select recording rate

**Samples** – Select the total number of recording points

**Display** – Select the way *DaqPRO* will display the data (at a rate of up to 1 sample per second):

1. *Numeric* – Displays the sensor values and the sample number
2. *Meter* – Displays all active sensors in a bar meter display along with their values (without decimals)
3. *Table* – Displays the last 6 values of all the active sensors in a table (without decimals)
4. *Graphic* – Displays a graphic representation of the sampled sensors

At rates higher than 1/s the *DaqPRO* will display the data in a graph at the end of the logging period.

**Start** – Press the Forward **arrow** to start recording



**Function**                      Display statistics of the current data

1. Minimum – The minimum graph value
2. Maximum – The maximum graph value
3. Average – The graph average

Use the **Enter** button to browse the different sensors



**Open**                              Open a stored data in graphic display

Use the Forward and Backward **Arrow** buttons to browse the stored files, press the **Enter** button to open a file

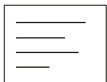

**Notes**                              Display user information

Use the **Arrow** buttons to browse the notes.

You can use the DaqLab software to edit the notes or to write new notes.



### **System Information**

Display system information:

1. Comment (use DaqLab to enter a comment)
2. Number of files stored in *DaqPRO*'s internal memory
3. Memory usage
4. Ambient temperature (the readings of the internal temperature sensor)
5. Current date and time



### **Help**

On-line help and specifications



### **Configuration**

Configure the *DaqPRO*:

**Compensation method** – Select between internal or external temperature compensation for thermocouple measurements.

If you choose the external compensation you must connect an NTC 10k temperature probe to input 1 and the thermocouple sensor to any other input, and then setup the device accordingly.

**Average** – Select number of averaging points

**Temperature units** – Select between Fahrenheit and Celsius

**Clear memory** – Delete the stored data files

**Contrast** – Use the **arrow** buttons to tune the screen contrast

## **1.2.4. Graphic Display**

*DaqPRO* will automatically use a graphic display in three cases:

- If the recording rate is every second or less and you selected Graphic Display in the setup menu.
- Once logging has ended for a recording rate of over one per second.





- When opening a stored recording.



The graphic display is available for recordings with up to 4 sensors simultaneously.

### 1. The Cursor

Use the **Cursor in Graphic Display** mode to read data values or to zoom in to the area around a selected point. The cursor is displayed automatically after logging has ended, or when opening a stored recording.

- Use the **Forward**  and **Backward**  arrow buttons to move the cursor.  
*DaqPRO* displays the point coordinates at the bottom of the graph.
- If there is more than one sensor, press the **Enter** button  to move the cursor to another plot on the graph.

### 2. Zooming

- Position the cursor in the area you want to zoom into.
- Press the two arrow buttons,  and , simultaneously. You will zoom in around the cursor in a 2:1 ratio.
- Press the **Escape** button  to zoom out.

### 1.2.5. Load the Last Setup

When you turn *DaqPRO* on, once the self-testing has been completed, the following will be displayed:

```

- - - INITIALIZATION - - -
DaqPRO ver 3.0h
Init. Display
Init. RAM

Loading SETUP...
```

The last setup is then automatically loaded.

### 1.2.6. Configuring your *DaqPRO*

Use the **System Configuration** menu to select the thermocouple temperature compensation method, to select number of averaging points, to set temperature units, to clear the *DaqPRO*'s memory or to change the screen contrast.



In the **MAIN MENU** screen, select the **System Configuration** icon to display the configuration screen:

```

- - - CONFIGURATION - - -
-> Int Compensation
Average 4 samples
Temperature in °C
Clear memory ( > )
Contrast ( < ) ( > )
```



Use the **Forward** and **Backward** arrow buttons to select the mode and then press the



Press the **Enter** button to move to the next item. You can press the **Escape** button to leave the configuration menu at any time, saving the new changes you made. Press the **Enter** button in the last item (Contrast) if you want to go back to the first item (Compensation).

The new configuration will be saved until the next time you change it.

## 1. Temperature Compensation

Use the **Forward**  and **Backward**  **arrow** buttons to select a temperature compensation mode for thermocouple measurements.

Select **Int Compensation** to use the internal temperature sensor or select **Ext Compensation** if you use an external temperature probe.

If you choose the external compensation you must connect an NTC 10k temperature probe to input 1 and the thermocouple sensor to any other input, and then setup the device accordingly.

## 2. Averaging Points

Use this option to reduce random noises. *DaqPRO* replaces every data sample with the average of the last preset number of samples.

Use the **Forward**  and **Backward**  **arrow** buttons to select the number of averaging samples.

To filter out 50/60Hz line noises use a high number of averaging points (12 to 15 points).

## 3. Temperature Units

Use the Arrow buttons to select between Fahrenheit (°F) and Celsius (°C) temperature units.

## 4. Clear Memory

Press the **Forward**  arrow button if you want to delete all previous data files from the *DaqPRO*.

## 5. Screen Contrast

Use the **arrow** buttons to adjust the LCD screen contrast.

Any contrast adjustment will be saved until the next time you change it.

### 1.2.7. *Internal Clock and Calendar*

The internal clock is set the first time you use the **Setup** command from the DaqLab software to program the *DaqPRO*, and is automatically updated to the PC's time and date each time you connect your *DaqPRO* to a PC.

The internal clock and calendar is kept updated independent of the 7.2V battery condition, even when the *DaqPRO* is turned off.

### 1.2.8. *Clearing the Memory*

If you want to start recording and the *DaqPRO*'s internal memory is full, you will see this message at the bottom of the display:

```
In - 1 Voltage 0-10V
In - 2 Empty
In - 3 Empty
In - 4 Empty

SAMPLES = 200
DISPLAY = graphic
Mem full, clear = ( > )
```



Press the **Forward** arrow button to clear the memory.

In order to clear the *DaqPRO*'s memory when it is not full, use the **Memory clear** command from the **Configuration** menu (refer to page 20), or clear the memory from the **Logger** menu in the **DaqLab software** (refer to page 53).

### 1.2.9. *Choosing the Right Setup*

#### 1. Sampling Rate

The sampling rate should be determined by the rate of change of the phenomenon being sampled. If the phenomenon is periodic, sample at a rate of at least twice the expected frequency. Changes in temperature can be measured at slower rates such as once per second or even slower, depending on the speed of the expected changes. It is usually good practice to sample at a rate 10 times higher than the expected frequency but for extremely smooth graphs, the sampling rate should be about 20 times the expected frequency.

**Note:** Sampling at a rate slower than the expected rate can cause *frequency aliasing*. In such a case, the graph will show a frequency much lower than expected. In Figure 6 below, the higher frequency sine wave was sampled at 1/3 of its frequency. Connecting the sampled points yielded a graph with a lower, incorrect frequency.

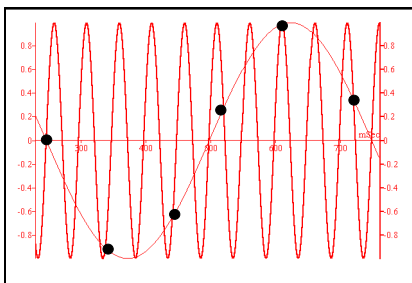

**Figure 6: Frequency Aliasing**

### Manual sampling

Use this mode for:

- Recordings or measurements that are not related to time.
- Situations in which you have to stop recording data after each sample obtained, in order to change your location, or any other logging parameter

**Note:** During recording **NO CHANGES** can be made to the *DaqPRO's* configuration).

To start a recording using manual data logging, set the **RATE** to manual and press the **Enter** button



once to start the data recording, then press the **Enter** button each time you want to collect a sample.

## 2. Sampling Points

After you have chosen the sampling rate, choosing the number of points will determine the logging period:  $\text{Samples} / \text{Rate} = \text{Logging time}$ . You can also choose the duration of a run first, and then calculate the number of samples:  $\text{Samples} = \text{Logging time} \times \text{Rate}$ .

### 3. Continuous Mode

In the Continuous mode, *DaqPRO* must be connected to the PC and the DaqLab software must be running. In this mode *DaqPRO* can continue logging indefinitely. The data is automatically downloaded to the computer, displayed in a real-time graph and saved every 10 minutes. There you don't need to download the data from the *DaqPRO* directly as the data is already displayed on the graph.

*DaqPRO* stores the data until its memory is full. You can download this data only if you stopped logging before this point.

To operate in Continuous mode select **RATE** equal to or less than 1/s and **SAMPLES = Continuous**.

You can also select Continuous mode directly from the DaqLab software.

The maximum sampling rate under Continuous mode is 1 second.

**Note:** *DaqPRO* must be set to a display mode other than graphic to enable the Continuous mode.

#### 1.2.10. Programming Rules and Limitations

The following are some rules and limitations you must take into account when programming the *DaqPRO*, as *DaqPRO* integrates all programming limitations automatically. *DaqPRO* will only allow the programming of settings that comply with the rules below.

##### 1. Sampling Rate

The number of sensors in use limits the maximum sampling rate:

- Maximum sampling rate with one sensor is 4000/s, when using the Current or Voltage sensors.
- Maximum sampling rate when using any of the temperature sensors is 1/s. For instance, when using thermocouples, internal temperature sensors, and so on.
- Maximum sampling rate with two or more sensors *of any type* is 1/s.
- *DaqPRO* displays readings in real-time at rates up to 1/s (Continuous mode)
- DaqLab displays online readings at rates up to 100/s, depending on the sensors connected. If temperature sensors are being used, then the maximum rate is 1/s.

**Note:** These programming limitations apply to v3.0h or higher of the *DaqPRO*.

## 2. Sampling Points

Increasing the number of active inputs limits the number of sampling points one can choose. The following condition must be always satisfied:

$$\text{Number of samples} \times \text{Active Inputs} \leq \text{Memory}$$

*DaqPRO*'s memory is sufficient for 512,000 samples.

The table below lists the maximum number of sampling point according to the number of sensors:

Number of Sensors	Maximum Number of Sampling Points
1	512,000 (exact number: 522,752)
2	256,000 (exact number: 260,608)
3	128,000 (exact number: 129,536)
4	128,000 (exact number: 129,536)
5	64,000
6	64,000
7	64,000
8	64,000

## 3. Continuous Sampling

- Continuous sampling is possible up to a maximum sampling rate of 1/s
- The data must be presented in a display mode other than Graphic i.e. Numeric

# Chapter 2

## *Working with DaqLab*

### 2.1. Installing the Software

#### 2.1.1. *System Requirements*

To work with DaqLab, your system should be configured with the following:

##### **1. Software**

- Windows 98 or later
- Internet Explorer 5.0 or later

##### **2. Hardware**

- Pentium 200MHz or higher
- 32 MB RAM (64 MB recommended)
- 10 MB available disk space for the DaqLab application (50 MB to install the supporting applications)

#### 2.1.2. *Installation*

1. Close all programs
2. Insert the CD labeled DaqLab into your CD-ROM drive

Installation will begin automatically. Simply follow the on-screen instructions to continue.



If **auto run** is not working, open **My Computer** and click on the CD drive folder (**d:** drive in most cases) and double-click on the setup icon, then follow the on-screen instructions.

**To uninstall the software:** From the Start menu select Settings and click on **Control Panel**, then use the **Add/Remove Programs** feature to remove the DaqLab application.

When updating the software, always remove the old version before starting a new installation.

#### To install the USB driver on WinXP:

1. Connect your data logger to a USB port on your PC and turn the data logger on. Windows will automatically detect the new device and open the **Found New Hardware Wizard**.
2. Select the **No, not this time** to prevent Windows from searching for software on the Internet, then click **Next**.
3. Insert the DaqLab installation CD into your CD drive. Windows will automatically detect and copy the necessary files to your system.
4. Click **Finish**. Windows will open the **Found New Hardware Wizard** for the second time.
5. Click **Next** to complete the installation. Windows will automatically install the necessary components on your system.
6. Click **Finish**.

#### Note to the Windows XP user:

If the **Found New Hardware** wizard prompts you to the following Hardware Installation dialog box, click **Continue Anyway** to proceed.

:



## 2.2. Overview

### 2.2.1. *DaqLab On-screen Layout*

DaqLab is a comprehensive program that provides you with everything you need in order to collect data from the *DaqPRO* display the data in graphs, meters and tables and analyze it with sophisticated analysis tools.

The program includes three windows: A graph window, table window, and a navigation window called the Data Map. You can display all three windows simultaneously or in any combination.

The most commonly used tools and commands are displayed on two toolbars. Tools that relate to all aspects of the program and tools that control the *DaqPRO* are located in the main (upper) toolbar. Tools specific to the graphs are located on the graph (lower) toolbar.

### 2.2.2. *Working with Projects*

Every time you start a new recording, DaqLab automatically creates a new project file. All the information you collect and process for a given session is stored in a single project file. Each of these files contain all the data sets you collect with the *DaqPRO*, the analysis functions you've processed, specific graphs you've created, and the DaqLab settings for the recording.

<b>Note:</b> All data sets in a single project must be with the same sampling rate.
---

### 2.2.3. DaqLab Window Layout

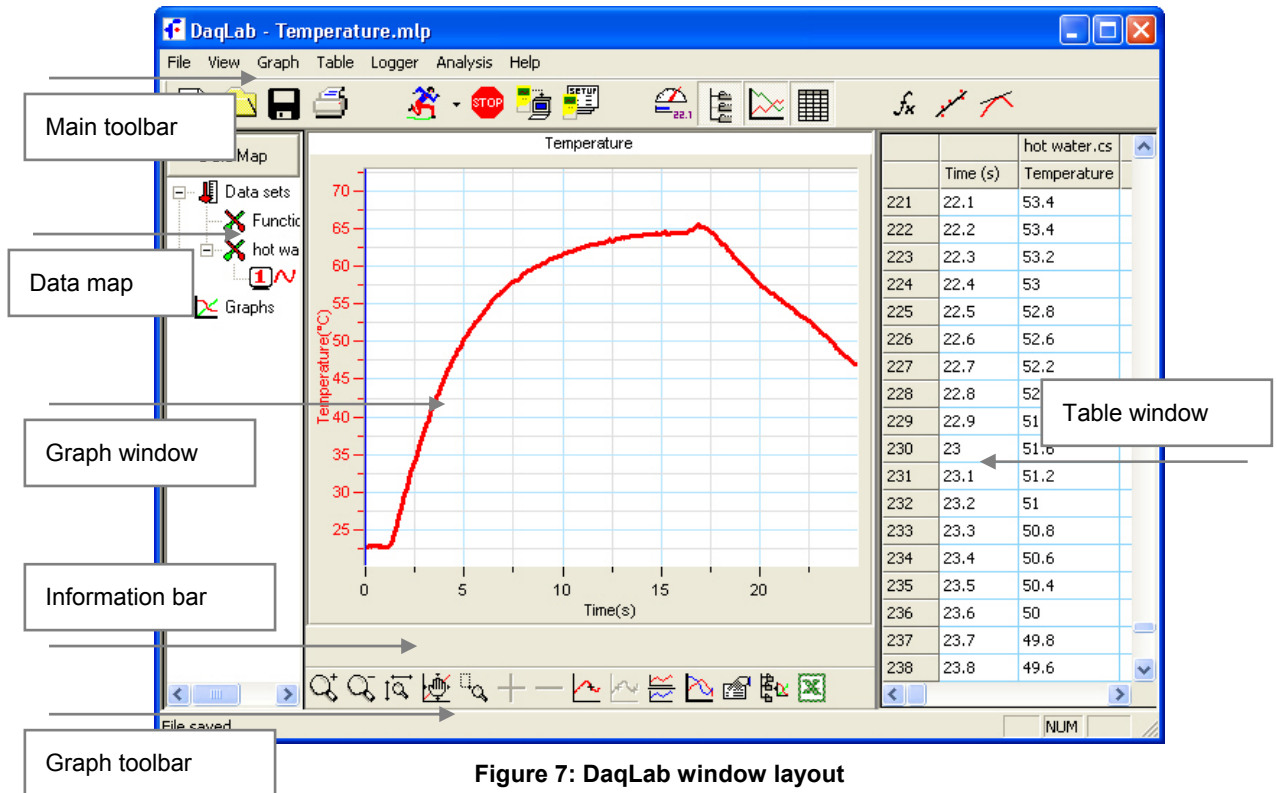

Figure 7: DaqLab window layout

## 2.3. Getting Started

### 2.3.1. Setting up a Recording Session

#### 1. Prepare DaqPRO

- a. Connect *DaqPRO* to the PC (refer to page 4)
- b. Turn on *DaqPRO*
- c. Plug in any external sensors
- d. Open the DaqLab software

You can open DaqLab by double clicking its icon  on the desktop or from the start menu

#### 2. Setup the DaqPRO

- a. Click **Setup Wizard**  on the main toolbar
- b. Follow the instructions in the Setup Wizard (refer to page 47)

#### 3. Start Recording

- a. Click **Run**  on the toolbar to start recording.

If the recording rate is 100 measurements per second or less, DaqLab automatically opens a graph window displaying the data in real time, plotting it on the graph as it is being recorded. If the recording rate is higher than 100/s, the data will be downloaded and displayed automatically, once the data recording is finished.

- b. You can stop recording anytime by clicking **Stop**  on the toolbar.

### 2.3.2. *Data Recording Options*

To set the behavior of the data display when you start a new recording session, click on the **down arrow**

next to the **Run** button , and select one of the following:

#### 1. **Single Measurement**

DaqLab will open a new project file every time you start a new recording session.

#### 2. **Replace**

DaqLab will display the new data set in place of the old set. The project's old data sets will still be available in the same project file. They will be listed in the Data Map and you can add them to the display at any time

#### 3. **Add**

DaqLab will add the new data set to the graph in addition to the old ones.

**Note:** A maximum of 8 data sets can be displayed on the graph at the same time.

### 2.3.3. *Downloading Data*

Whenever data is received from the *DaqPRO*, it is accumulated and displayed automatically by DaqLab. There are two modes of communication: Online and Offline.

#### **Online Communication**

When *DaqPRO* is connected to the PC and programmed to run at sampling rates of up to 100/s, *DaqPRO* transmits each data sample immediately, as it is recorded, to the PC. The software thus displays the data in real-time in both the graph window and the table window.

When *DaqPRO* is connected to the PC and programmed to run at a sampling rate of 500/s or higher, data is accumulated in *DaqPRO*'s internal memory. This data is not transmitted to the PC until the recording period has ended, when the data is automatically downloaded to the PC and displayed.

#### **Offline Data Logging**

- To download data that was recorded offline, or while *DaqPRO* was not connected to a PC, connect *DaqPRO* to the computer, run the DaqLab program and click **Download**



on the main toolbar. This will initiate the Post-Recording Data Transfer communication mode. Once the transfer is complete, the data will be displayed automatically in the graph window and in the table window. If there are several files stored in the *DaqPRO*, the first download will bring up the most recent file; the second download will bring up the second most recent file, and so on.

- If you are logging offline at rates of up to 1/s, you can connect *DaqPRO* to the computer and download the accumulated data at anytime. Apart from during the transfer period, the data will be downloaded without interrupting the logging process.
- To download a particular file, choose **Selective download** from the **Logger** menu, then select the file's number in the Download dialog.
- Click **Cancel** in the Download progress window at any time to stop downloading the data.

### Data Dump

If the file you are attempting to download is corrupted for any reason e.g. you turned off the *DaqPRO* in the middle of logging, before the data could be properly backed up, then DaqLab will download all data up to the point where the data becomes corrupted and cannot be downloaded.

This is called **Data Dump**.

### 2.3.4. Saving Data



Click **Save** on the main toolbar to save your project. This will save all the data sets and graphs under one project file.

Saving the project will also save any special formatting and scaling you performed.

If you made any changes to a previously saved project, click **Save** to update the saved file or select **Save as...** from the file menu to save it under another name.

#### Note:

To delete a specific data set, a graph or a table from the project, use the Data Map (refer to page 43)

To remove unwanted data from a specific data set, apply the crop tool (refer to page 78).

### 2.3.5. *Opening a File*



1. Click **Open** on the main toolbar.
2. Navigate to the folder where the project is stored.
3. Double click the file name to open the project.

DaqLab opens the project and displays the first graph on the graph list. If the project does not include saved graphs, the file opens with an empty graph window. Use the Data Map (refer to page 43) to display the desired data set.

### 2.3.6. *Creating a New Project*

There are three ways to create a new project:

- Open the DaqLab program, which will open a new file each time.
- When working in Single Measurement mode, a new project is opened every time you click the **Run** button to start a new recording.
- Any time you click the **New** button  on the toolbar.

### 2.3.7. *Import Data*

Any file that is in comma separated values text format (CSV) can be imported into DaqLab.

To import a CSV file:

1. Click **File** on the menu bar, then click **Import CSV file**.
2. In the dialog box that opens, next to **Look in**, navigate to the drive and folder that contains the CSV file.
3. Select the file.
4. Click **Open**.

#### **Tips:**

To create a text file in a spreadsheet:

1. Open a new spreadsheet.

Enter your data according to the following rules:

- a. The first row should contain headers. Each header includes the name of the data set and units in brackets, e.g. Voltage (V)

- b. The first column should be the time. The time interval between successive rows must match the time intervals accepted by DaqLab. You can export DaqLab files to Excel to learn about these time formats.

For example, refer to the table below:

	A	B	C
1	t(s)	x(m)	y(m)
2	0	0	5
3	0.1	0.95	4.05
4	0.2	1.8	3.2
5	0.3	2.55	2.45
6	0.4	3.2	1.8
7	0.5	3.75	1.25
8	0.6	4.2	0.8

2. On the **File** menu, click **Save As**.
3. In the **File name** dialog box, type a name for the workbook.
4. In the **Save as type** list, click the CSV format.
5. Click **Save**.

To import files that were previously exported from DaqLab, open DaqLab and import the file as described above (as they are already in CSV format).

### 2.3.8. *Date Format Settings*

To set the way data will be displayed on screen, click **Date format settings** to open the Date format settings dialog:

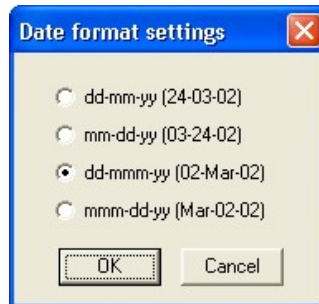

**Figure 8: Date format settings dialog box**

Click the desired option, then click **OK**.



### 2.3.9. *Print*

#### 1. Print a Graph

- a. Click **Print**  on the main toolbar.
- b. Select the Graph 1 option (when in split graph mode you can choose between Graph 1 and Graph 2).
- c. Click **Print** to open the print dialog box.
- d. Click **OK**.  
DaqLab will print exactly what you see in the graph display.

#### 2. Print a Table

- a. Click **Print**  on the main toolbar.
- b. Select the **Table** option.  
If you want to print only a specific range, uncheck the **Print all data** check box and type the desired row numbers into the **To** and **From** text boxes.
- c. Click **Print** to open the print dialog box.
- d. Click **OK**.  
DaqLab will print exactly what you see in the table display as well as the *DaqPRO* comment, serial number and the alarm level setup. Data that exceeds any of the alarm levels will be highlighted by arrows.

## 2.4. Viewing the Data

### 2.4.1. Display Options

The DaqLab program's screen consists of three parts: the graph window, table window and Data Map window. You can display all three parts simultaneously (the default view) or any combination of the three.

The graph window is the main window by default and is displayed in the center of the application window.

In addition to these sections, you have the option to display an on-screen meter for each of the sensors (refer to page 43).

### 2.4.2. Graph Display

Click **Graph**  to display or hide the graph. The default graph display is the data set or sets plotted vs. time, but you can change the X-axis to represent any of the individual data sets (refer to page 39).



The graph usually displays all the data sets of a given recording, but you can use the Data Map to remove one or more of the sets from the graph (refer to page 43).

In order to keep the graph clear and simple, only two Y-axes are shown on the graph at once. If there are three curves in the graph, one of the Y-axes is hidden. In order to make this axis visible, select the corresponding plot with the cursor (refer to bullet 2 below).

You can identify the Y-axis by its color, which matches the plot color.

#### 1. Split Graph View

DaqLab enables you to display your data in two separate graphs within the graph window.

- a. Click **Split graph**  on the graph toolbar to split the graph window into two separate graphs.
- b. Click **Edit graph**  on the graph toolbar to open the **Edit graph** dialog box.
- c. Choose which data sets to display on each of the graphs (or use the Data Map to do so – refer to page 43).

To return to the single graph display, click **Split graph**  a second time.

## 2. The Cursor

You can display up to two cursors on the graph simultaneously.

Use the first cursor to display individual data recording values, to select a curve or to reveal the hidden Y-axis.

Use two cursors to display the difference between two coordinate values, to display the frequency of periodic data or to select a range of data points.

### To display the first cursor:

Double click on an individual data point or click **Cursor**  on the graph toolbar. You can drag the cursor with the mouse onto any other point on the plot, or onto a different plot. For finer cursor movements use the forward and backward keys on the keyboard.

The coordinate values of the selected point will appear in the information bar at the bottom of the graph window.

### To display the second cursor:

Double click again anywhere on the graph area or click **2<sup>nd</sup> Cursor**  .  
The information bar will now display the difference between the two coordinate values.

### To remove the cursors:

Double click anywhere on the graph area, or click **1<sup>st</sup> Cursor** a second time.

### To remove the 2<sup>nd</sup> cursor:

Click **2<sup>nd</sup> Cursor** a second time.



### To display the cursors in split graph mode:

To display the cursors on the upper graph, use the same method as for single graph mode.



To display the cursors on the lower graph, you must first remove them from the upper graph and then double click anywhere on the lower graph to display the first cursor. Double click a second time to display the second cursor, and double click a third time to remove the cursors.

### 3. Zooming



*To zoom in to the center of the graph*

- Click **Zoom in**  on the graph toolbar
- To reverse the operation, click **Zoom out**  on the graph toolbar

*To zoom in to a specific data point*

- Select the point with the cursor (see above)
- Click **Zoom in**  on the graph toolbar
- To reverse the operation click **Zoom out**  on the graph toolbar

*To zoom in to a range*

- Select the range with both cursors
- Click **Zoom in**  on the graph toolbar
- To reverse the operation click **Zoom out**  on the graph toolbar



*To zoom in to a specific area*

- Click **Zoom to selection**  on the graph toolbar and drag the cursor diagonally to select the area you want to magnify. Release the mouse button to zoom in to the selected area.
- Click **Zoom to selection** a second time to disable the zoom tool.

*Autoscale*

Click **Auto scale**  on the graph toolbar to view the full data display, or double click on an axis to auto scale that axis alone.

### Manual scaling

- a. Click **Graph properties**  on the graph toolbar to open the **Graph properties** dialog.
- b. Select the **Scale** tab, and choose the axis you want to scale in the **Select axis** drop-down menu.
- c. Uncheck the **Autoscale** check box and enter the new values in the text box.
- d. Click **OK**.
- e. To manually scale a specific axis, right click on the axis to open its Properties dialog.
- f. To restore auto scaling click **Autoscale** .

### The stretch/compress axis tool

- a. Move the cursor onto one of the graph axes. The cursor icon changes to the double arrow symbol ( $\leftrightarrow$ ), indicating that you can stretch or compress the axis scale. Drag the cursor to the desired location. Repeat the procedure for the other axis if necessary.
- b. Double click on the axis to restore auto scaling.

## 4. Panning

- a. Use the pan tool after zooming in to see any part of the graph that is outside the zoomed area.
- b. To do this, click **Pan**  on the graph toolbar, then click anywhere on the graph and drag the mouse to view another area.
- c. Click **Pan** a second time to disable the Pan tool.

## 5. Edit the Graph

- a. Use the **Edit graph** dialog box to select which data sets to display on the graph's Y-axis and to change the X-axis from time, to one of the data sets.

- b. Click **Edit graph**  on the graph toolbar to open the **Edit graph** dialog box:

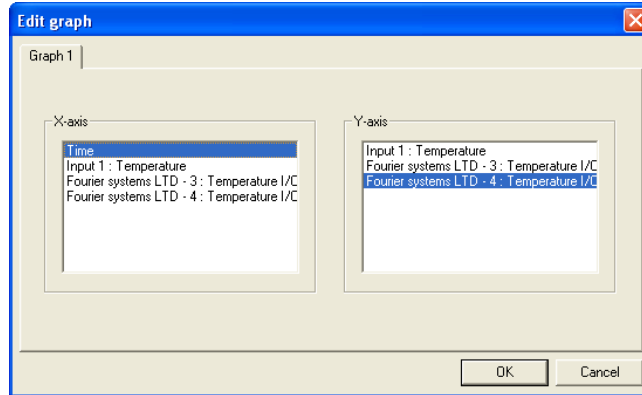

**Figure 9: Edit graph dialog box**

- c. To select a data set to display on the Y-axis, click on the data set's name in the Y-axis list. To display more than one curve, click on the data sets you want.
- A list entry that begins with a *DaqPRO* comment denotes a recorded data set. A list entry that begins with an input number denotes the next recording and will be displayed on the graph the next time you start a recording.
- d. To deselect a data set, click on it a second time.
- e. To select a data set for display on the X-axis, click on the data set's name in the X-axis list. You can only select one data set at a time for the X-axis.
- f. Click **OK**.

## 6. Display Alarm Levels

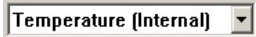
- a. Click **Display alarm level** .
- b. Select the sensor you wish to display from the select sensor drop list .
- c. To display alarm levels on graph 2 in split graph mode, click the down arrow next to the button and select graph 2.

## 7. Format the Graph

You can change the data line's color, style and width. You can also add markers that represent the data points on the graph and format their style and color.

The color of the Y-axis matches the corresponding plot's color and will automatically change with any change made to the color of the corresponding plot.

- a. Click **Graph properties**  on the graph toolbar to open the **Graph properties** dialog box.
- b. Select the **Lines** tab, and then select the plot or axis you want to format in the Select plot drop-down menu.
- c. From here you can format the line's color, style and width, as well as the markers' color and style. To remove the line or the marker, uncheck the corresponding Visible check box.
- d. Click **OK**.
- e. To restore the default formatting, click **Restore default**.

## 8. Change the Graph's Units and its Number Format

- a. Click **Graph properties**  on the graph toolbar to open the **Graph properties** dialog box.
- b. Select the **Units** tab, and then select the plot or axis you want to format in the Select plot drop-down menu.
- c. Choose the prefix option.
- d. Select the desired number of decimal places.
- e. To display numbers in scientific format, check the **Scientific** check box.
- f. Click **OK**.

## 9. Add a Graph to the Project

DaqLab displays new data in the graph window every time you start a new recording. You can always display previous data using the **Edit graph** dialog or by double-clicking on the data's icon in the **Data**

**Map.** If you want to save a graph that you created to your project, or to update a saved graph with changes you made, use the **Add to project** tool:

Click **Add to project**  on the graph toolbar.

### 2.4.3. *The Table Display*

Click **Table**  to display or to remove the table window.

The data in the table always matches the data that is currently displayed on the graph.

When you start a new recording, DaqLab displays the new data in the table as well as on the graph.

#### 1. Formatting the Table

##### *Changing column width*

Drag the boundary on the right side of the column heading until the column is the desired width.

##### *Changing row height*

Drag the boundary below the row heading until the row is the desired height.

##### *Formatting the fonts*

- a. Click **Table** on the menu bar, then click **Properties**.
- b. Select the **Font** tab.
- c. Format the font, as well as the font's style and size.
- d. Click **OK**.

##### *Changing units and number format*

- a. Click **Table** on the menu bar, then click **Properties**.
- b. Select the Units tab, and then select the plot you want to format from the Select plot drop-down menu.
- c. Choose the prefix option.
- d. Select the desired number of decimal places.



- e. To display numbers in scientific format, check the Scientific check box.
- f. Click **OK**.

#### 2.4.4. Meters

DaqLab enables you to view data in meters format on the screen (one meter for each sensor), with up to four meters showing at once. The meters can display live data while DaqLab is recording, or saved data when a saved file is replayed.

When a cursor is displayed, the meter shows the measured values that correspond to the time of the point at which the cursor is positioned.

There are three meter types: Analog, bar and digital.

The meter's scaling automatically matches the graph's scaling.

To set up the meters:

- a. Click **Meter Setup**  on the main toolbar.
- b. Select the meter type, and the data set to be displayed.  

A list entry that begins with a graph number denotes a displayed data set. A list entry that begins with an input number denotes the next recording, and will be displayed on the meter the next time you start a recording
- c. Repeat this procedure for up to four meters.
- d. To remove the meters click **Meter Setup** , and click **Remove all**.

#### 2.4.5. Data Map

Click **Data Map**  to display or remove the Data Map.

The data map is a separate window that displays the list of data sets that were recorded or downloaded in the current session, as well as the lists of all the saved graphs. Use the Data Map to navigate through the available data sets and to keep track of the data that is being displayed in the graph window.

**Note:** The data in the table always matches the data that is currently displayed on the graph.

## 1. Control the Display with the Data Map

The items in the Data Map are sorted into two main categories:

- Data sets (including analysis functions)
- Saved graphs

Double click on a category to bring up the full list. Double click a second time to collapse the list. You can also use the plus (+) and minus (-) signs next to the icons to expand or collapse the categories.

The Data sets' list expands to sub-categories of recorded data and functions. To display the complete list of measurements, or the complete list of analysis functions performed on the measurements for any individual data capture, double click the file's icon or click the plus sign (+) next to it.

To collapse a list under an individual data capture, double click the corresponding icon or click the minus sign (-) next to it.

To display a data set or a saved graph double click its icon. Double click a second time to remove it.

You can also use a shortcut menu to display or remove a data set from the graph. Simply right-click an icon, then click **Display on graph #1** or **Display on graph #2**.

To delete an individual item from the Data Map and from the project, right-click on its icon and click

**Delete**. To permanently delete the item, click **Save**  on the main toolbar.

To remove all data sets from the Data Map, right-click the Data sets icon  and click **Clear All Data**.

## 2. Understanding Data Map Icons



Data sets list



Functions – Includes all the analysis functions of the project



Individual function – Currently not on display



Individual function – Currently displayed on graph 1



Individual function – Currently displayed on graph 2



Individual function – Currently displayed both on graphs 1 and 2



Function



Data capture – Includes all recorded data of the recording











Individual data set – Currently not on display



Individual data set – Currently displayed on graph 1



Individual data set – Currently displayed on graph 2

-  Individual data set – Currently displayed both on graphs 1 and 2
-  Raw data
-  List of saved graphs
-  Saved graph – Data sets vs. time
-  Saved graph – Data sets vs. data set
-  Graph currently not on display
-  Graph currently displayed on graph 1
-  Graph currently displayed on graph 2
-  Graph currently displayed both on graphs 1 and 2

## 2.4.6. *Exporting Data to Excel*

Click **Export to Excel**  on the graph toolbar, or go to **Graph > Export to Excel**, to export the data that is currently displayed on the graph to Excel. DaqLab will then open a new Excel workbook displaying the data as well as the *DaqPRO* comment, serial number and the alarm level setup. Data that exceeds any of the alarm levels will be highlighted by arrows.

### 1. Export all Open Data Sets

You can easily export all open data sets in the Data Map to the same Excel file, at once, rather than individually as in previous versions of DaqLab. Each data set will be exported to a separate worksheet.

Go to **File > Export project to Excel**.

### 2. Exporting over 64,000 Samples to Excel

Each worksheet in the Excel application allows up to 64,000 rows of data to be imported. If your data set contains over 64,000 sampling points, then additional worksheets will be created when exporting this data to Excel. For instance, if you have a data set containing 100,000 points then Excel will create two worksheets, one containing the maximum 64,000 points and the second containing the remaining 36,000 points.

### 3. Export File Settings

If DaqLab fails to export the data properly, try to change the export file settings:

- a. Click **File** on the menu bar, then click **Export file settings**.
- b. Check the **Ignore regional settings** check box and click **OK**.

#### 2.4.7. *Copying the Graph as a Picture*

You can copy the graph to the clipboard as a picture and then paste it to other Windows programs such as Word or PowerPoint:

1. In the **Graph** menu, click **Copy graph**.
2. Open the destination file.
3. In the destination file, right click and select **Paste**.

## 2.5. Programming DaqPRO

### 2.5.1. Setup

#### 1. Quick Setup

Use the Setup wizard to guide you through the Setup process.

- a. Click **Setup Wizard**  on the main toolbar to open the setup wizard:

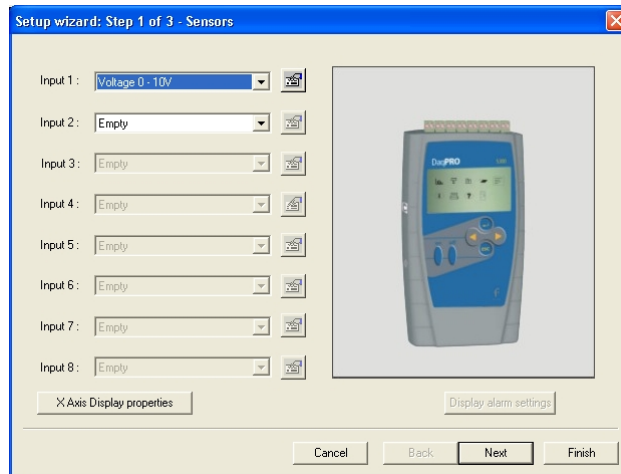
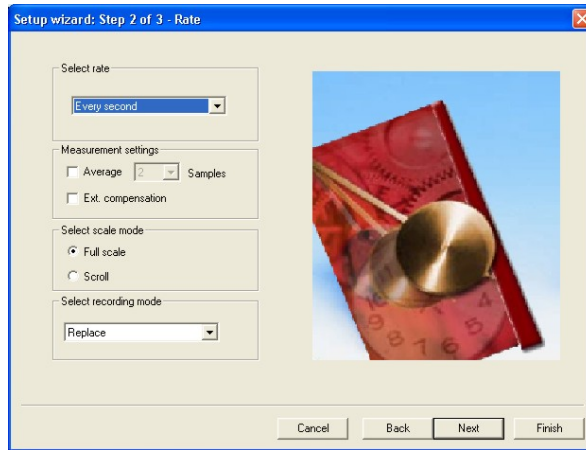

**Figure 10: Setup wizard step 1 of 3**

The first step is to assign sensors to each input. Select the sensors you are using from the corresponding input drop-down menus.

To set alarm levels and alarm action click Display alarm settings (refer to page 49 for detailed alarm setup).

- b. Click **Next** to move to the second step:



**Figure 11: Setup wizard step 2 of 3**

- c. Select the desired recording rate in the **Select rate** drop-down menu.
- d. Select the **Scroll** option if you want the graph window to scroll as the data recording progresses.
- e. Select the desired data recording mode in the **Select recording mode** drop-down menu.
- f. Click **Next** to move to the third step:

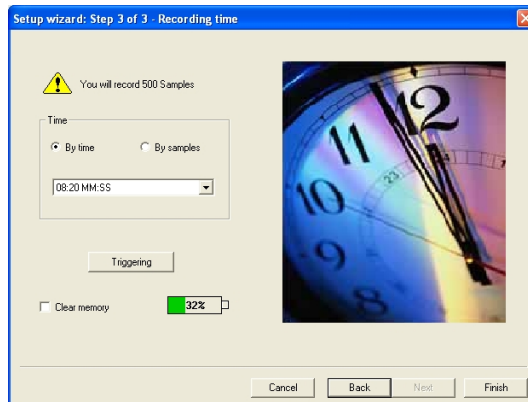

**Figure 12: Setup wizard step 3 of 3**

- g. Select the desired length of the recording period in the **Select recording time** drop-down menu. The recording period is displayed as a unit of time by default. To display the recording period as the number of recording samples, select the **By samples** option. The number of samples is calculated with the following formula:

$$\boxed{\text{Total recording sample} = \text{Recording rate} \times \text{Recording period}}$$

- h. To start the data recording only when a specific time or measurement condition has been met, click **Triggering** to open the triggering dialog box (refer to page 52).
- i. Click **Finish** to complete the setup and to send the setup command to the *DaqPRO*.

## 2. Alarm Setup

You can setup alarm levels and output for each sensor input individually in the first step of the **Setup wizard**:

- a. Click **Setup Wizard**  on the main toolbar to open the setup wizard.
- b. Click **Display alarm settings** to show the alarm controls:

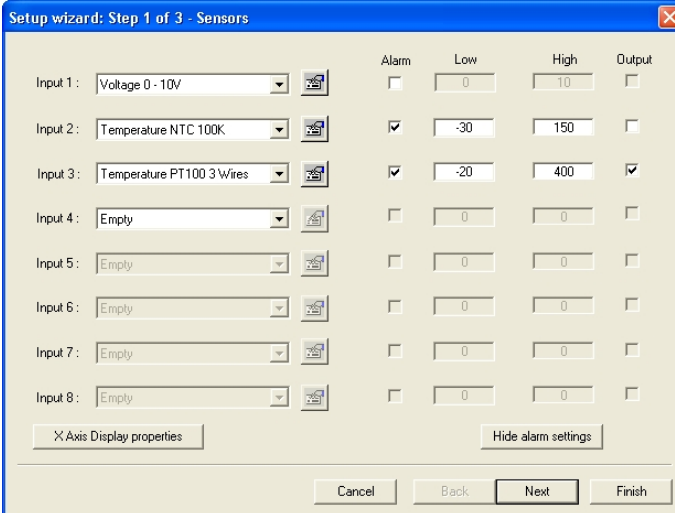

Input	Sensor Type	Alarm	Low	High	Output
Input 1	Voltage 0 - 10V	<input type="checkbox"/>	0	10	<input type="checkbox"/>
Input 2	Temperature NTC 100K	<input checked="" type="checkbox"/>	-30	150	<input type="checkbox"/>
Input 3	Temperature PT100 3 Wires	<input checked="" type="checkbox"/>	-20	400	<input checked="" type="checkbox"/>
Input 4	Empty	<input type="checkbox"/>	0	0	<input type="checkbox"/>
Input 5	Empty	<input type="checkbox"/>	0	0	<input type="checkbox"/>
Input 6	Empty	<input type="checkbox"/>	0	0	<input type="checkbox"/>
Input 7	Empty	<input type="checkbox"/>	0	0	<input type="checkbox"/>
Input 8	Empty	<input type="checkbox"/>	0	0	<input type="checkbox"/>

**Figure 13: Alarm settings**

- c. Check the checkbox or checkboxes near the inputs you want to activate the alarm.

- d. Type in **Low** and/or **High** alarm levels.
- e. If you want a sensor or sensors to activate the alarm output check the corresponding **Output** checkbox or checkboxes.
- f. Click **Next** to proceed to step 2 of the Setup wizard or click **Finish** to complete the alarm setup. Refer to page 8 to learn more on alarms and alarm output.
- g. You can set DaqLab to display the alarm levels on the Graph window (refer to page 40).

### 3. Temperature Compensation

Use this option if you wish to use an external temperature probe to compensate for thermocouple measurements.

If you choose the external compensation you must connect an NTC 10k temperature probe to input 1 and the thermocouple sensor to any other input, and then setup the device accordingly.

Check the **Ext Compensation** checkbox in step 2 of the Setup wizard.

### 4. Averaging

Use this option to reduce random noises. *DaqPRO* replaces every data sample with the average of the last pre-set number of samples

To apply averaging:

Check the **Averaging** checkbox in step 2 of the Setup wizard, and select the number of samples to average from the drop-down menu.



### 5. Battery Level

A battery level indicator is displayed in step 3 of the Setup wizard. The indicator shows the remaining working hours as a percent of the battery's life (approximately 25 hours between charges), before it should be recharged.

### 6. Presetting the Display

You may want to define the graph's settings, such as formatting and scaling the graph and selecting the axes, and to define the meters' settings prior to beginning a recording session. You can define the settings of each sensor input individually in the first step of the **Setup wizard**:



- a. Click **Setup Wizard**  on the main toolbar to open the Setup wizard.
- b. Click **Properties**  next to the input you want to set.
- c. Click the **Display properties** tab.
- d. Select a measurement from the **Select measurement** drop-down menu.
- e. Select the graph or graphs in which you would like to display the data, from the **Display on graph** drop-down menu.
- f. Select a meter in the **Meter type** drop list if you want to display the data in a meter as well as on the graph.
- g. Format the line and markers in the **Plot** section.
- h. If you want a specific scale, uncheck the **Auto scale** check box and enter the desired minimum and maximum values of the axis.
- i. Click **OK**.

## 7. Preset the Graph's X-axis

- a. Click X-Axis display properties in the first step of the Setup wizard to open the dialog:

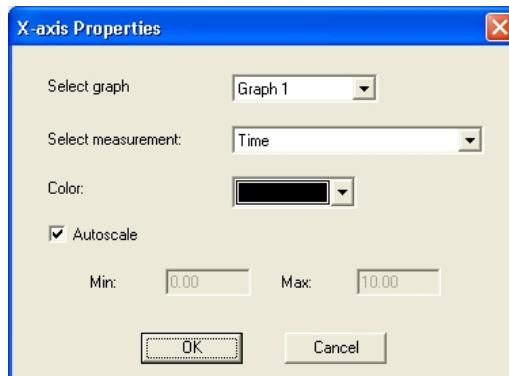
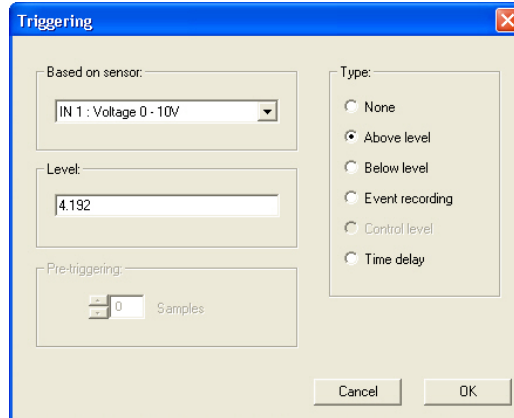

**Figure 14: X-axis properties dialog box**

- b. Select the graph you wish to modify.
- c. Select the measurement you wish to display on the X-axis.
- d. If you want a specific scale, uncheck the **Auto scale** check box and enter the minimum and maximum values of the axis.
- e. Click **OK**.

## 8. Triggering

To start the data recording only when a specific time or measurement condition has been met, click **Triggering** in step 3 of the Setup wizard to open the triggering dialog:



**Figure 15: Triggering dialog box**

Select the triggering sensor in the **Based on sensor** text box.

Choose one of the following from the **Type** options:

- **None** – Trigger is disabled.
- **Above level** – Start logging only once the measured value is **Higher** than the trigger level.
- **Below level** – Start logging only once the measured value is **Lower** than the trigger level.
- **Event Recording** – This function enables you to record the exact time and date at which a certain phenomenon occurred: The trigger level set for this

option is actually a threshold setting. Each time the threshold is crossed, *DaqPRO* will record the exact time and date of the occurrence, and will continue to do so until the desired number of samples has been obtained.

When logging has ended download the data to the PC (if *DaqPRO* is already connected to the PC it will be done automatically). The event list will be displayed in the table window. You can now save the list, export it to Excel or print it.

**Note:** The trigger condition must be fulfilled for at least 300 $\mu$ S.

- **Time delay** – This trigger type enables you to set a timer that will start the logging after a predetermined amount of time. After setting the trigger to Timer Delay, click the down arrow on the **Level** combo-box, and select from the 17 different time options. The timer will start its countdown when you click **RUN**, and the actual recording will start once the countdown has ended.

Select the trigger level in the **Level** drop-down menu and click **OK**.

**Note:** When you turn off *DaqPRO*, it will save the setup for the next session.

### 2.5.2. Starting Recording



Click **Run** on the main toolbar. Click the **down arrow** to change the recording mode.

### 2.5.3. Stopping Recording



Click **Stop** on the main toolbar

### 2.5.4. Clearing *DaqPRO*'s Memory

To erase all data currently stored in the *DaqPRO*, click **Clear memory** in the **Logger** menu (*DaqPRO* must first be connected to the PC).

### 2.5.5. Adding a Comment to *DaqPRO*

You can add a comment to each *DaqPRO*. The comment will serve as a name to identify the specific *DaqPRO* in addition to its serial number. Every time data is being downloaded from a *DaqPRO*, its comment and the serial number will be displayed in the graph title and on the corresponding icon in the

Data Map. To display the comment on *DaqPRO*'s LCD select the **System information** menu (refer to page 16).

The comment and the serial number will also be displayed in prints and exported files.

**Note:** the comment can include up to 32 characters.

To add a comment:

1. Connect *DaqPRO* to the PC.
2. Click **Logger** on the menu bar, then click **Set comment**.
3. Click the **Comment** text box and type a comment (e.g. its location).
4. Click **OK** to upload the edited notes to *DaqPRO*.

### 2.5.6. Edit *DaqPRO*'s Notes

1. Connect *DaqPRO* to the PC.
2. Select **Edit notes** from the **Logger** menu to open the **Notes** dialog box with the *DaqPRO*'s current notes downloaded to the window.

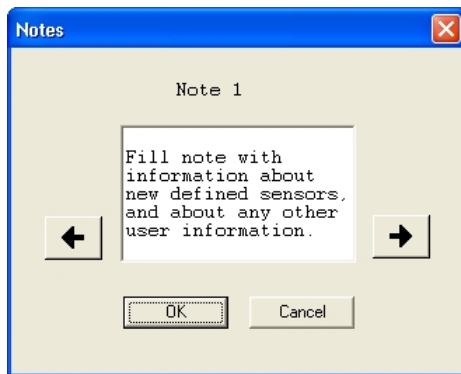

**Figure 16: Edit notes dialog box**

From this dialog, you can edit, delete, or write new notes.

**Note:** A note is limited to 140 characters and a maximum of 3 notes can be stored in *DaqPRO* at any time.

3. Use the arrow buttons to move to the next note, or to the previous one.
4. Click **OK** to upload the edited notes to *DaqPRO*.

### 2.5.7. *Temperature Units*

To select between Fahrenheit (°F) and Celsius (°C) temperature units:

Click **Logger** on the menu bar, point to **Temperature units** and then select the desired units.

### 2.5.8. *Calibrating the Sensors*

**Note:** This section reflects software updates made in **DaqLab v1.30.09** and higher. If you are running an older version of DaqLab, some of the features described here may differ from the features available in your DaqLab version.

#### 1. Introduction to *DaqPRO* Calibration

The *DaqPRO* ships from the factory fully calibrated. When you first connect your unit to DaqLab, the software automatically saves these factory calibration settings to two locations:

- To a file named **factorydefaults.daq**, located in the DaqLab directory on your PC.
- To a **.cal** file, located in the *Calibration Settings* folder in the DaqLab directory on your PC. The **.cal** file name is your *DaqPRO*'s S/N e.g. 123456.cal.

#### 2. Working with the **factorydefaults.daq** File

DaqLab automatically stores the factory default calibration parameters of the *DaqPRO* the first time the logger communicates with the software. When you connect additional *DaqPRO*'s to the PC for the first, their calibration parameters are also stored in this file.

As this file must maintain the factory default settings, it is never updated, even after you recalibrate your *DaqPRO*.

As mentioned above, the *DaqPRO* ships fully calibrated. However, replacing the firmware chip or the internal lithium battery erases these calibration parameters on the *DaqPRO* and resets the logger's S/N to 0.

When you then connect the *DaqPRO* to DaqLab, the following error message will therefore appear:

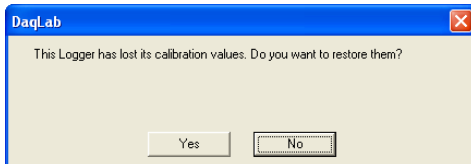

**Figure 17: Lost calibration error message**

**Note:** This error message will also appear if for any reason the factorydefaults.daq file is not found. **Do not delete the factorydefaults.daq file!**

1. Click **Yes** to restore the calibration parameters and to display the following dialog box:

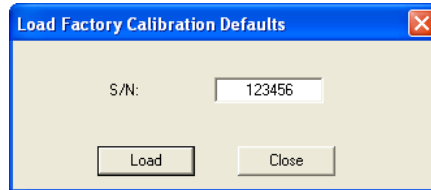

**Figure 18: Loading factory calibration defaults**

2. Enter your *DaqPRO* serial number in the S/N text box (you will find the serial number on the manufacturer's sticker on the back of your logger).
3. Click **Load**. DaqLab will then load the logger's default calibration settings saved in the factorydefaults.daq file. DaqLab will also reset the logger's correct S/N.
4. If for any reason this file is not located in the DaqLab directory, this procedure will fail.

You can choose to restore the factory defaults at any time:

1. Click **Logger** on the menu bar, and then click **Calibration > Load Factory Calibration Defaults**.
2. Enter your *DaqPRO* serial number in the S/N text box (you will find the serial number at the back of your device).
3. Click **Load**.

If the factorydefaults.daq file has been deleted, read below for alternative instructions on retrieving your *DaqPRO*'s default calibration settings.

### 3. Saving the Calibration Settings Manually

As a further backup to this factorydefaults.daq file, DaqLab has a feature (new to v1.30.09) enabling you to manually save a file containing your logger's current calibration settings.

You can therefore save a separate calibration file following each *DaqPRO* calibration procedure.

If you have lost your factorydefaults.daq file or simply want to restore the settings to a previous state having this .cal file as a back-up will allow you to do so.

### **Saving the calibration settings**

To save the *DaqPRO*'s present calibration settings:

1. Go to **Logger > Calibration > Save Calibration Settings**.
2. Select the save location and click **Save**.

The file will be saved according to the logger's S/N e.g. 123456.cal.

### **Loading the calibration settings**

To load the *DaqPRO*'s calibration settings:

1. Go to **Logger > Calibration > Load Calibration Settings**.
2. Browse to the file location and click **Open**.

DaqLab will now load the calibration settings to the *DaqPRO*.

### **Backing up the factorydefaults.daq File**

Rename the .cal file created when first connecting the *DaqPRO* to DaqLab, to backup123456.cal (123456 is the loggers S/N). Save this file in a safe place. Therefore, if for any reason the factorydefaults.daq file is lost, you can simply load this file and retrieve your logger's default calibration settings.

**Note:** You can change the .cal file name but you cannot load a .cal file of one *DaqPRO* onto another.

## **4. Calibration Options**

Although the *DaqPRO* comes fully calibrated, DaqLab enables you to calibrate any of the *DaqPRO* sensors except for the internal temperature sensor, which doesn't need calibration. The calibration parameters are sent to *DaqPRO* and stored in its memory.

### **Tips:**

- Prior to any two-point or zero calibration procedure you must restore factory defaults.
- Calibrating a sensor type applies to all inputs except for 50mV, TCJ, TCK and TCT types.
- Prior to calibrating any of the thermocouple sensor types, calibrate the Voltage 50mV sensor as this will set the gain (slope) of all thermocouple sensor types.
- After calibrating 50mV, TCJ, TCK or TCT sensor types for all inputs you can refine the offset calibration for each input individually.
- Calibrating the PT 100 2-wires sensor applies also to PT 100 3-wires except for fine offset calibration.
- The internal temperature sensor needs no calibration.

DaqLab employs three different calibration methods: **Two-point calibration**, **Offset calibration** and **Zero calibration**. When selecting a sensor type to calibrate, DaqLab prompts you to the appropriate calibration procedure:

Sensor	Type	Calibration Method
Current	0 - 24mA	Two-point calibration
Temperature	NTC 10K	Zero calibration
Temperature	NTC 100K	Zero calibration
Temperature	PT-100 2-wire	Two-point calibration
Temperature	PT-100 3-wire	Two-point calibration*
Temperature	Thermocouple J	Offset calibration
Temperature	Thermocouple K	Offset calibration
Temperature	Thermocouple T	Offset calibration
Voltage	0 - 10V	Two-point calibration
Voltage	0 - 50mV	Two-point calibration

### Two-point Calibration

The two-point calibration sets the gain (slope) and offset (intercept) of the sensor's conversion function. Use the two point calibration to calibrate the voltage and current sensors and the PT100 temperature sensors.

\* To calibrate the PT100 3 wire, first calibrate the PT100 2-wire as the slopes of their conversion functions are identical. Then proceed to adjust the PT100 3-wire offset.

In some cases you may need to refine your calibration using the fine offset tuning tool.

### Offset Calibration

To calibrate the thermocouple temperature sensors: TC-J, TC-K and TC-T, first calibrate the 50mV sensor type. That will set the slope for all thermocouple temperature sensors. Then proceed to adjust the offset using the Offset calibration technique.

### Zero Calibration

The zero calibration sets only the offset (intercept) of the sensor's conversion function. Use the zero calibration to calibrate the NTC 10k and NTC 100k temperature sensors.

## 5. Calibration Password

To prevent accidental change of the calibration, the calibration procedure is protected by a password. **The default password is: 1234**



**To change the password:**

- a. Click **Logger** on the menu toolbar, and then click **Calibration > Calibrate Sensors**.
- b. Click **Change Password** to open the **Change Password** dialog box.
- c. Enter the current password in the **Current Password** text box.
- d. Enter the new password in the **New Password** text box.
- e. Enter the new password a second time in the **Confirm New Password** text box to confirm your new password.
- f. Click **OK**.

**Note:** The password must include at least 4 characters and is **case sensitive**.

## **6. Calibration Procedure**

### **Two-point Calibration**

*Measure two reference values*

- a. Connect *DaqPRO* to the PC.
- b. Click **Logger** on the menu bar, then click **Calibration > Calibrate Sensors**.
- c. Enter the calibration password, and then click **OK**.
- d. Choose a sensor from the **Select sensor** drop-down menu and click **OK** to open the **Sensor calibration** dialog box:

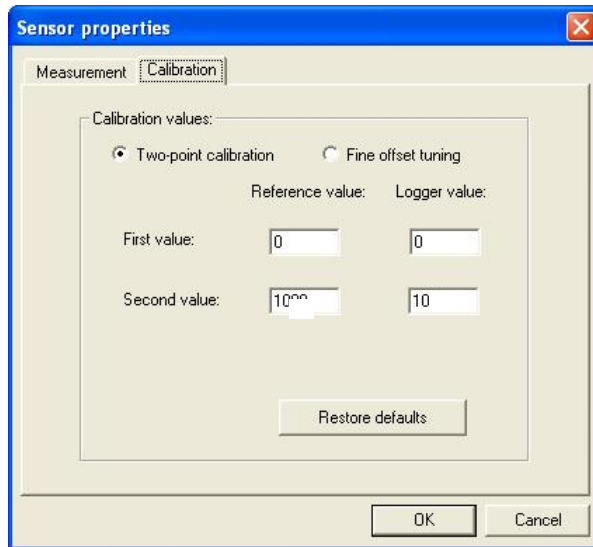

**Figure 19: Two-point calibration dialog box**

**Note:** We strongly recommend calibrating using the values that appear in the two Reference value text boxes

- e. If not selected, click the **Calibration** tab.
- f. Click **Restore defaults**, then click **OK**.
- g. Measure two known reference values and record both the reference values and the values displayed by DaqLab.

*Enter calibration values*

- a. Repeat steps 1 to 5 above.
- b. Select the **Two-point calibration** option.
- c. Enter a distinct reference value in each of the **Reference Value** text boxes and the corresponding logger values in each of the **Logger Value** text boxes (the logger values are the values displayed by DaqLab when measuring the two reference values).
- d. Click **OK**.

## Fine Offset Calibration

If, after the calibration procedure, *DaqPRO* still exhibits some offset value use the Fine offset tuning tool to correct it.

The offset value is the difference between the value displayed by *DaqPRO* and the reference value. For example if the calibrator is set to 0 °C and *DaqPRO* reads 1 °C the offset value is +1, but if *DaqPRO* reads -1 °C then the offset value is -1.

- a. Connect *DaqPRO* to the PC.
- b. Click **Logger** on the menu bar, then click **Calibration > Calibrate Sensors**.
- c. Enter the calibration password, then click **OK**.
- d. Choose a sensor from the **Select sensor** drop-down menu and click **OK** to open the **Sensor calibration** dialog box.
- e. Select the **Fine offset calibration** option.
- f. Enter the offset value.
- g. Click **OK**.

The calibrated sensor parameters will be saved both in *DaqPRO* and DaqLab memories, so there is no need to calibrate *DaqPRO* every time you run the DaqLab program.

## Voltage 50mV Calibration

To calibrate the 50mV sensor type first use the two-point method as described above, then proceed to offset calibration as described below.

## Offset Calibration

Calibrating any of the thermocouple sensors comprises of two steps.

First calibrate the 50mV voltage sensor to set the slope of the sensor's conversion function. Then use the calibration procedure described below to calibrate the sensor's offset.

The offset calibration is automatically applied to all input. If more accurate calibration is needed, the software lets you set the offset to each input separately.

**Note:** *DaqPRO* ships fully calibrated for all inputs simultaneously.

*Measure two reference values*

**Before taking measurements you need to disable the temperature compensation both in *DaqPRO* and in the calibrator.**

To disable the temperature compensation in *DaqPRO*:

Click **Logger** on the menu bar, point to **Thermocouple Compensation**, and then click **Disable**.

**Note:** Don't forget to enable the temperature compensation prior to normal operation of *DaqPRO*. One way to enable the temperature compensation is to turn *DaqPRO* off and on again. Another way is via DaqLab: Click **Logger** on the menu bar, point to **Thermocouple Compensation**, then click **Enable**.

*To take two reference measurements*

Measure two known reference values and record both the reference values and the values displayed by DaqLab. Calculate the offset values.

The offset value is the difference between the value displayed by *DaqPRO* and the reference value. For example, if the calibrator is set to 0 °C and *DaqPRO* reads 1 °C the offset value is +1, but if *DaqPRO* reads -1 °C then the offset value is -1.

*Enter the offset value*

- a. Connect *DaqPRO* to the PC.
- b. Click **Logger** on the menu bar, then click **Calibration > Calibrate Sensors**.
- c. Enter the calibration password, then click **OK**.
- d. Choose a sensor from the **Select sensor** drop-down menu and click **OK** to open the **Sensor calibration** dialog box:

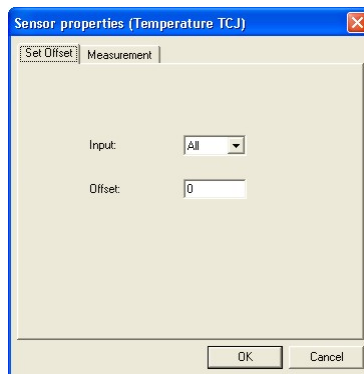

**Figure 20: Offset calibration dialog box**

- e. If not selected, click the **Set Offset** tab.
- f. Ensure that **All** is selected in the **Input** drop-down menu.
- g. Enter the offset value in the **Offset** text box (if the two offset values are not identical enter the average of the two values).
- h. Click **OK**.

#### *Setting the offset to a specific input*

After setting the offset to all inputs simultaneously, you can set the offset of each input separately for even better accuracy.

To set the offset of a specific input:

- a. Measure two known reference values as described in **Measure two reference values** above, making sure to use the input you need to calibrate.
- b. Enter the offset value as described in **Enter the offset value** above, making sure to select the correct input number in step f, instead of **All**.
- c. You can repeat the procedure for every input.

#### **Zero Calibration**

- a. Connect *DaqPRO* to the PC.
- b. Click **Logger** on the menu bar, then click **Calibration > Calibrate Sensors**.
- c. Enter the calibration password, then click **OK**.
- d. Choose a sensor from the **Select sensor** drop-down menu and click **OK** to open the **Sensor calibration** dialog box:

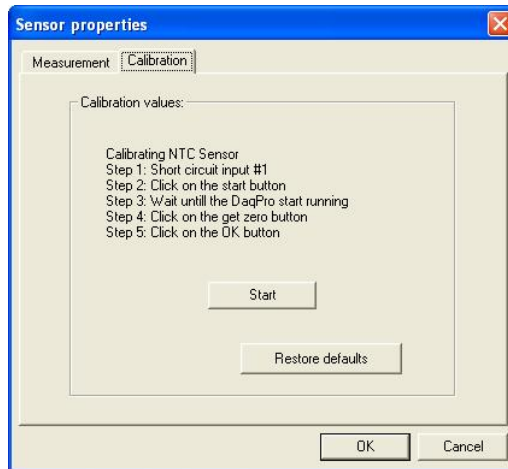

**Figure 21: Zero calibration dialog box**

- e. Click **Restore defaults**, then click **OK**.
- f. Repeat steps a to d above.
- g. Short circuit input 1.
- h. Click **Start**.
- i. Wait until *DaqPRO* begins recording.
- j. Click **Get zero**.
- k. Click **OK**.

The calibrated sensor parameters will be saved both in *DaqPRO* and DaqLab memories, so there is no need to calibrate *DaqPRO* every time you run the DaqLab program.

### 2.5.9. Defining a Custom Sensor

DaqLab enables the user to define custom sensors. This is a useful tool for when *DaqPRO* is communicating with many sensors from **different vendors**.

Any additional sensor that you would like to connect to *DaqPRO* must comply with the following restrictions:

- The sensor's output must be either voltage in the range of 0 to 10V or current in the range of 4 to 24mA.
- The sensor Transfer Function (sensor output voltage changes vs. the sampled phenomenon changes) must be a linear Transfer Function.

To define a new sensor:

1. Connect *DaqPRO* to the PC.
2. Click **Logger** on the menu bar, then click **Define New Sensor** to open the **Define New Sensor** dialog box:

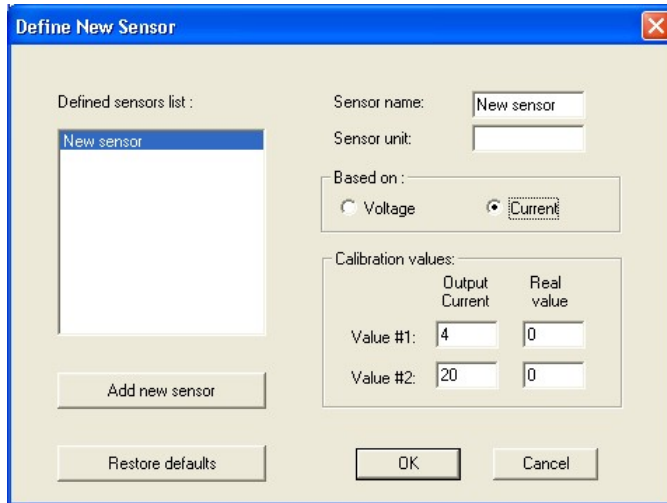

Figure 22: Define New Sensor dialog box

3. Click **Add New Sensor**.
4. Select a **Based on** option (depending on whether your sensor's output is 0 to 10V or 4 to 24mA).
5. Enter a sensor name and sensor unit.
6. Enter two calibration values (two real values and the corresponding output values of the sensor).

7. Click **OK**.
8. *DaqPRO* will send the definition to *DaqPRO* and will add the new sensor to the sensor list.

*To use the custom sensor:*

1. Plug the custom sensor into *DaqPRO*.
2. Set up *DaqPRO* using the Setup Wizard (refer to page 47) and select the sensor from the sensor list next to the corresponding input.
3. Proceed with the setup as you would normally do.

### 2.5.10. Communication Setup

Communication between the PC and *DaqPRO* takes place automatically whenever you send a command to *DaqPRO*. However, the **Communication Setup** dialog box can be used for more advanced communication options.

1. Click **Logger** on the menu bar, and then click **Com setup**. DaqLab will display a dialog reporting what COM Ports are already in use, and which port is recommended for use with *DaqPRO*:

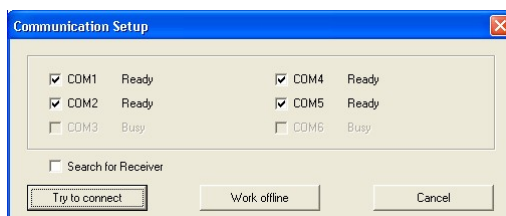

**Figure 23: Communication Setup dialog box**

2. Click **Try to connect** and DaqLab will try to communicate with *DaqPRO*. If communication is achieved, DaqLab will designate the selected port as *DaqPRO*'s communication port.
3. You can override the DaqLab recommendation and choose the COM Port yourself by clicking the check box to the left of the desired port, and clicking **Try to connect**.

**Note:** In the event of communication malfunction, please refer to the troubleshooting guide on page 82.

4. You can click **Work offline** if you wish to work without *DaqPRO*. While working offline, you can still open or import saved files to view and analyze them.



## 2.6. Analyzing the Data

### 2.6.1. *Reading Data Point Coordinates*

Position the cursor (refer to page 37) on a point to display its coordinates on the information bar at the bottom of the graph window.

If more than one curve is displayed, and you want to read the Y coordinates of all of the curves simultaneously, bring up digital meters (refer to page 43) for each of the curves. When you position a cursor on one curve, the meters will show the corresponding Y-coordinates for the other curves.

### 2.6.2. *Reading the Difference between two Coordinate Values*

Position one cursor on the first point and a second cursor on the second point to display the difference between the two coordinate values on the information bar at the bottom of the graph window

### 2.6.3. *Working with the Analysis Tools*

The analysis tools can only be applied to data sets that are displayed in the graph window.

Use the cursors (refer to page 37) to select the graph and the data range to which you want to apply the analysis.

Select the analysis function you wish to use.

The analysis function will be added onto the graph, with the exception of the smoothing (averaging) function, which will replace the original data set.

### 2.6.4. *Smoothing*

The smoothing tool is very useful in reducing random *noises*, especially if you want to apply any analysis functions to the data. The smoothing process replaces every data point with the average of its neighboring points.

1. Use the cursor to select the function on the graph that you want to smooth.

2. Click **More smoothing**  on the graph toolbar.

3. You can repeat the procedure to further smooth the data.

4. Click **Less smoothing**  to reduce the amount of smoothing.

## 2.6.5. *Statistics*

Use the statistics tool to display statistics of a selected data set or a range of data.

The statistics include:

**Average** – The average of all the numbers in the range

**StDev.** – The standard deviation

**Minimum** – The smallest value in the range

**Maximum** – The largest value in the range

**Sum** – Adds all the numbers in the range

**Area** – The area between the graph and the x-axis in the range

**Samples** – The number of data points in the range

**Rate** – The recording rate

*To display statistics:*

1. Use the cursors to select the graph and the data range to which you want to apply the statistics
2. Click **Analysis** on the menu bar, then click **Statistics**.

DaqLab will open a statistics window in which it will display the results.

## 2.6.6. *Most Common Analysis Functions*

### 1. **Linear Fit**

Click **Linear Fit**  on the main toolbar to draw a line of linear least square fit and to display the line's equation  $y = ax + b$

**Note:** If you want the automatic curve fit equation to start at  $t = 0$ , apply the crop tool before applying the linear fit (refer to page 78).

## 2. Derivative

Click **Derivative**  on the main toolbar to construct a graph in which each point is the slope of the 3 consecutive points on the source graph.

## 3. Integral

Choose **Integral** from the **Analysis** menu to construct a graph in which each point is the integral of all the preceding points on the source graph.

### 2.6.7. *The Analysis Wizard*

#### 1. Using the Analysis Wizard

The Analysis Wizard will guide you through the various analysis functions available in the DaqLab program. The analysis functions are grouped into three main categories: Curve fit (regression), averaging, and mathematical and trigonometric functions.

To apply an analysis function to a data set:

- a. Use the cursors to select the graph or data range to which you would like to apply the analysis.
- b. Click **Analysis Wizard**  on the main toolbar.
- c. Click a Category tab:
  - Curve fit
  - Averaging
  - Functions

## 2. Curve Fit

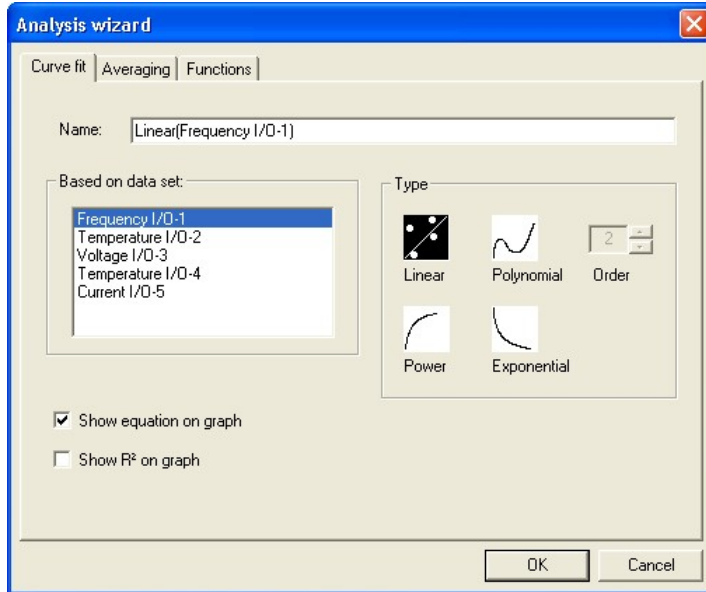
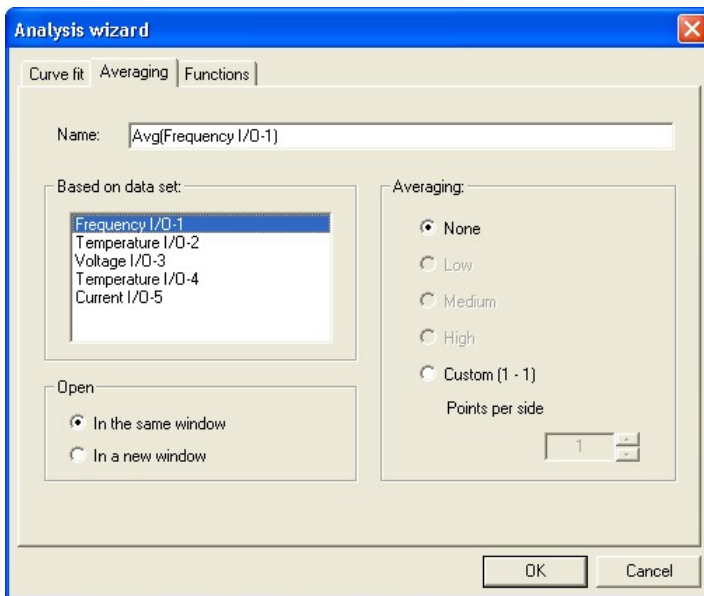

**Figure 24: Analysis wizard – Curve fit**

- Select a fit Type by clicking its icon (if you choose polynomial fit, select the order you want).
- If you use the cursor to select a data set, it will be highlighted in the **Based on data set** list, but you have the option of selecting a different data set.
- Type a name in the **Name** box (optional - the default name includes both the function and the data set names).
- Click the **Show equation on graph** check box to display the line's equation on the information bar.
- Click the **Show R<sup>2</sup> on graph** check box to display the correlation coefficient on the information bar.
- Click **OK**.

**Note:** If you want the automatic curve fit equation to start at  $t = 0$ , apply the crop tool before any type of curve fitting (refer to page 78).

### 3. Averaging



**Figure 25: Analysis wizard – averaging**

- If you use the cursor to select a data set, it will be highlighted in the Based on data set list, but you have the option of selecting a different data set.
- Select an averaging option (if you choose custom averaging, choose the number of averaging points in the **Points** box).
- Enter a name in the **Name** text box (optional - the default name includes both the function and the data set names).
- Select an **Open** option.
- Click **OK**.

## 4. Functions

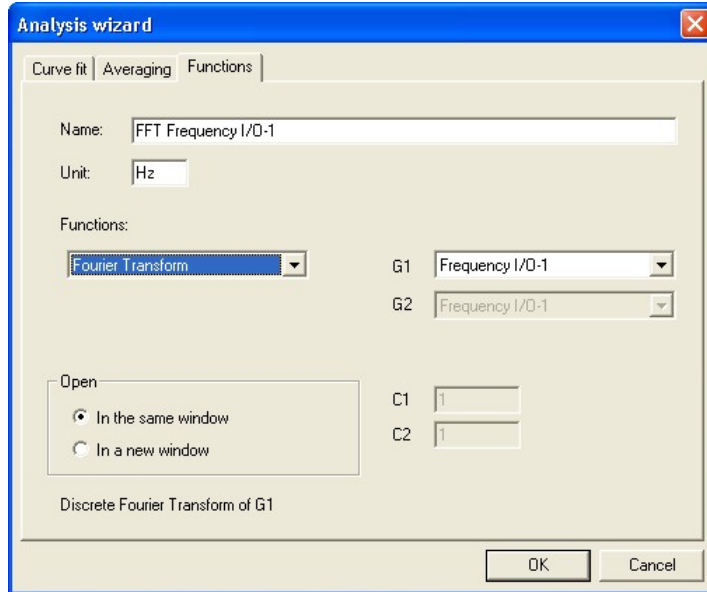

**Figure 26: Analysis wizard – functions**

- Select a function from the **Functions** list. DaqLab displays the function's formula at the bottom of the dialog.
- If you use the cursor to select a data set, it will be highlighted in the G1 drop list, but you have the option of selecting a different data set.
- If the analysis function involves two data sets, select the second data set from the G2 drop list.
- Enter a constant in each of the C1 and C2 boxes (optional).
- Enter a name in the **Name** text box (optional – the default name includes both the function's formula and the data set name).
- Enter a unit (optional).
- Select an **Open** option.

h. Click **OK**.

### 2.6.8. Available Analysis Tools

This section includes a brief description of each of DaqLab's analysis functions.

#### 1. Curve Fit

**Linear**  $y = ax + b$

Draws a line of linear least square fit

**Polynomial**  $y = a_0x^n + a_1x^{n-1} + \dots + a_n$

Draws a line of polynomial least square fit (you must select an order between 1 and 6.)

**Power**  $y = \frac{a}{x^n}$

Draws a line of power least square fit

**Exponential**  $y = ae^{bx}$

Draws a line of exponential least square fit

DaqLab displays the curve fit equation and the correlation coefficient ( $R^2$ ) on the information bar below the graph.

#### 2. Averaging

The average function replaces every point with the average of  $n$  neighboring points from both sides of the point.

Low averaging:  $n = 5$ , Medium averaging:  $n = 11$ , High averaging:  $n = 41$

### 3. Functions

In the formulas below,  $G_1$  and  $G_2$  represent selected data sets, and  $C_1$  and  $C_2$  are constants that you can enter. The constant's default value is 1.

**Absolute**       $y = C_1 |C_2 G_1|$

Draws a line of the absolute values of a data set

**Add**       $y = C_1 G_1 + C_2 G_2$

Draws a line of the addition of two data sets

**Arccosine**       $y = C_1 \arccos(C_2 G_1)$

Draws a line of the arccosine values of a data set (in radians). Arccosine is the angle whose cosine is  $C_2 G_1$ . The argument  $C_2 G_1$  must be between  $-1$  and  $1$ .

**Arcsine**       $y = C_1 \arcsin(C_2 G_1)$

Draws a line of the arcsine values of a data set in radians. Arcsine is the angle whose sine is  $C_2 G_1$ . The argument  $C_2 G_1$  must be between  $-1$  and  $1$ .

**Average**       $C_1 \cdot \{\text{average of } C_2 \text{ points around } G_1\}$

Replaces every point with the averaging of  $C_2$  neighboring points

**Cosine**       $y = C_1 \cos(C_2 G_1)$

Draws a line of the cosine values of a data set. The argument  $C_2 G_1$  must be expressed in radians.



**Delta Y**  $y = G_1 - G_1(t = 0)$

Draws a line of the difference between the Y-coordinate of every point and Y-coordinate of the first point. Use this function to move the data set along the Y-axis so that the point will intersect the Y- axis at the origin.

**Derivative**  $y_n = \frac{y_{n+1} - y_{n-1}}{2\Delta t}, \Delta t = \frac{1}{\text{sampling rate}}$

Draws a line of the slopes of every three consecutive points of a data set. For high recording rates and small  $\Delta t$ , this line may be very noisy, which is why smoothing the data set is recommended before applying the derivative function.

**Divide**  $y = C_1 G_1 / C_2 G_2$

Draws a line of the division of two data sets

**Envelope (lower)** Lower envelope of  $G_1$  with tolerance of  $C_1$  points

Draws a line that connects the minimum values of a data set. The tolerance defines the minimum distance (in sampling points) between two minima, so that the envelope function is able to ignore random *noises*.

**Envelope (upper)** Upper envelope of  $G_1$  with tolerance of  $C_1$  points

Draws a line that connects the maximum values of a data set. The tolerance defines the minimum distance (in sampling points) between two maxima, so that the envelope function will be able to ignore random *noises*.

**Exp.**

$$y = C_1 e^{C_2 G_1}$$

Draws a line of  $e$  raised to the power of a data set

**Fourier transform**

Discrete Fourier transform of  $G_1$ .

Draws a line of the amplitudes of the harmonics of Fourier transform vs. frequency

**Frequency**

The frequency of  $G_1$  (minimum of  $C_1$  points in one cycle).

Draws a line of the frequency of a periodic data set vs. time. The constant  $C_1$  defines the minimum data points in one cycle.

**Integral**

$$y = C_1 + C_2 \sum G_1 \Delta t$$

Draws a line in which each point is the discrete integral of all the preceding points in a data set

**Linear**

$$y = C_1 + C_2 G_1$$

Draws a line of a linear displacement of a data set. This function is useful when you want to change the point of origin of a data set.

**Ln**

$$y = C_1 \ln(C_2 G_1)$$

Draws a line of the natural logarithm of a data set. The argument  $C_2 G_1$  must be positive.

**Log**

$$y = C_1 \log_{10}(C_2 G_1)$$

Draws a line of the logarithm of a data set to base 10. The argument  $C_2 G_1$  must be positive.

**Multiply**

$$y = C_1 G_1 \cdot C_2 G_2$$

Draws a line of the multiplication of two data sets

**Reciprocal  
(1/X)**

$$y = \frac{C_1}{G_1}$$

Draws a line of the reciprocal values of a data set

**Sine**

$$y = C_1 \sin(C_2 G_1)$$

Draws a line of the sine values of a data set. The argument  $C_2 G_1$  must be expressed in radians.

**Square ( $X^2$ )**

$$y = C_1 (C_2 G_1)^2$$

Draws a line of the squares of a data set

**Square root**

$$y = C_1 \sqrt{C_2 G_1}$$

Draws a line of the square root values of a data set. The argument  $C_2 G_1$  must be greater than or equal to zero.

**Subtract**

$$y = C_1 G_1 - C_2 G_2$$

Draws a line the subtraction of two data sets

**Tan**

$$y = C_1 \tan(C_2 G_1)$$

Draws a line of the tangent values of a data set. The argument  $C_2 G_1$  must be expressed in radians.

## 2.7. Special Tools

### 2.7.1. *Crop Tool*

The Crop tool enables you to trim the edges of a data set. Use it to remove unwanted data.

The time scale of the trimmed data is shifted so that it will start at  $t = 0$ .

If you want the automatic curve fit equation to start at  $t = 0$ , apply the crop tool before any type of curve fitting

After applying the crop tool, the trimmed data set replaces the original set on the graph display and a new icon is added to the Data Map under cropped data.

#### 1. To Trim all Data Up to a Point

- a. Position a cursor (refer to page 37) on the data point.
- b. Click on the **Graph** menu, and then click **Crop**.

#### 2. To Trim all Data Outside a Selected Range

- a. Use the cursors to select the range you want to keep.
- b. Click on the **Graph** menu, and then click **Crop**.

## 2.8. Toolbar Buttons

### 2.8.1. Main (Upper) Toolbar



**New**

Start new project



**Open**

Open saved project



**Save**

Save project



**Print**

Select print options



**Run**

Start a data recording session. Click on the down-arrow to select recording mode.



**Stop**

Stop recording



**Download**

Download the data from the most recent recording session



**Setup**

Open the Setup dialog



**Meter Setup**

Open the Meter setup dialog



**Data Map**

Display the Data Map

**Graph**

Display the graph window

**Table**

Display the table window

**Analysis**

Open the Analysis wizard

**Linear Fit**

Draw a line of linear fit of the selected data set

**Derivative**

Draw a line of the derivative of the selected curve

**Display Alarm**

Displays or removes alarm levels from the graph

### 2.8.2. *Graph Toolbar*

**Zoom In**

Zoom in around a selected point or in to a selected range

**Zoom Out**

Reverse the most recent zoom operation

**Autoscale**

Display all the data

**Zoom to Selection**









Zoom in to a selected area

**Pan**

Pan in all directions while in zoom mode

**More Smoothing**

Smooth (average) the selected curve

	<b>Less Smoothing</b>	Reverse the most recent smoothing operation
	<b>1<sup>st</sup> Cursor</b>	Display or remove the first cursor
	<b>2<sup>nd</sup> Cursor</b>	Display or remove the second cursor
	<b>Split Graph</b>	Switch to a split graph display
	<b>Edit Graph</b>	Select the data to display on the axes
	<b>Graph Properties</b>	Graph formatting, scaling and units selection
	<b>Add to Project</b>	Add the displayed graph to the project
	<b>Export to Excel</b>	Export the displayed graph to Excel

# Chapter 3 Troubleshooting Guide

Symptom	Cause of Problem
I pressed the ON key on <i>DaqPRO</i> and it did not turn on.	<ul style="list-style-type: none"><li>• Try charging the battery, it may be weak.</li><li>• You are using an unsuitable AC/DC adaptor (refer to page 9).</li><li>• The internal 3V disk battery is dead.</li></ul>
DaqLab was unable to connect to <i>DaqPRO</i> .	<ul style="list-style-type: none"><li>• <i>DaqPRO</i> is turned off.</li><li>• The communication cable is not connected properly.</li><li>• The communication cable is not connected to the correct PC COM Port.</li><li>• There is no available Serial COM Port.</li></ul>
<i>DaqPRO</i> and DaqLab displays a warning message: <i>Illegal sensor</i>	<ul style="list-style-type: none"><li>• <i>DaqPRO</i> measured a voltage drop of over 5V across an input that was selected as one of the following types: 50mV, TCK, TCJ, TCT, PT 100 or NTC.</li><li>• <i>DaqPRO</i> measured a reversed voltage drop of over -1V across an input that was selected as one of the following types: 50mV, TCK, TCJ, TCT or 10V.</li></ul>
When detecting the <i>DaqPRO</i> , DaqLab displays a warning message that the logger's calibration file is lost.	<ul style="list-style-type: none"><li>• The <i>DaqPRO</i> has lost its calibration settings or its S/N has been reset to zero for an unknown reason.</li><li>• You must load the factorydefaults.daq file from the DaqLab directory to restore the calibration settings and restore the S/N.</li><li>• You can also load the .cal file containing more recent calibration settings than the factory defaults.</li></ul>



## Symptom

## Cause of Problem

I downloaded *unexpected* data.

- There may be up to 100 files stored in the *DaqPRO*. Performing a *Download* means loading one of them in sequential order. You have probably loaded an old file accidentally. Try using Selective download from DaqLab (refer to page 31).

While running with an active trigger, *DaqPRO* does not complete the data logging.

- The trigger condition has not been fulfilled.
- The trigger condition was fulfilled, but the time period was too short (less than 300 $\mu$ S).

I started a new session and the data logger stopped recording immediately afterwards.

- First check if the sampling rate was so fast that the recording began and ended in less than a second. If this is not the reason, recharge the 7.2V battery and try again. *DaqPRO* monitors the battery power during the logging. If the battery voltage is less than 5V, the logging is stopped automatically.

The recorded data is *noisy*

- With voltage or current sensors, use short connections between the circuit being tested and the sensor.
- Avoid working near strong electromagnetic fields. (e.g. engines, fluorescent lights)

*DaqPRO*'s memory is empty – there are no stored files or notes.

- The internal 3V disk battery is dead.

# Chapter 4 Specifications

## DaqPRO

### Inputs

- 8 channel differential inputs
- Selectable type for each input: 0-24 mA, 0-50 mV, 0-10 V, NTC, PT-100, Thermocouple, Pulse counter (Input 1 only), Frequency (Input 1 only) and User Defined sensors

### Input types

#### 0 – 24 mA

Range	0 to 24 mA
Resolution	0.47 $\mu$ A
Accuracy	$\pm 0.5$ %
Loop impedance	21 $\Omega$
Maximum load	30 mA, 5.2 V

#### 0 – 50 mV

Range	0 to 50 mV
Resolution	3 $\mu$ V
Accuracy	$\pm 0.5$ %
Input impedance	50 M $\Omega$
Maximum voltage	5.2 V

#### 0 – 10 V

Range	0 to 10 V
Resolution	200 $\mu$ V
Accuracy	$\pm 0.5$ %
Input impedance	125 K $\Omega$
Maximum voltage	25 V

#### Temperature NTC-1

NTC – 10 K $\Omega$ resistor	
Range	-25 to 150 $^{\circ}$ C
Resolution	0.05 $^{\circ}$ C
Accuracy	$\pm 0.5$ %

#### Temperature NTC-2

NTC – 100 K $\Omega$ resistor	
Range	-25 to 150 $^{\circ}$ C
Resolution	0.05 $^{\circ}$ C
Accuracy	$\pm 0.5$ %

#### Temperature PT100

Range	-200 $^{\circ}$ C to 400 $^{\circ}$ C
Resolution	0.1 $^{\circ}$ C (7 m $\Omega$ )
Accuracy	-200 to -50 $^{\circ}$ C $\pm 0.5$ %
	50 to 400 $^{\circ}$ C $\pm 0.5$ %
	-50 to 50 $^{\circ}$ C $\pm 0.5$ %

Possible to connect up to 8 PT100 2-wires or 4 PT100 3-wires

#### Temperature Thermocouple J

Range	-200 $^{\circ}$ C to 1,200 $^{\circ}$ C
Resolution	0.1 $^{\circ}$ C (1 $\mu$ V)
Accuracy	-200 to -50 $^{\circ}$ C $\pm 0.5$ %
	50 to 1200 $^{\circ}$ C $\pm 0.5$ %
	-50 to 50 $^{\circ}$ C $\pm 0.5$ %
Cold junction compensation	$\pm 0.3$ $^{\circ}$ C

#### Temperature Thermocouple K

Range	-250 to 1200 $^{\circ}$ C
Resolution	0.1 $^{\circ}$ C (1 $\mu$ V)
Accuracy	-250 to -50 $^{\circ}$ C $\pm 0.5$ %
	50 to 1200 $^{\circ}$ C $\pm 0.5$ %
	-50 to 50 $^{\circ}$ C $\pm 0.5$ %
Cold junction compensation	$\pm 0.3$ $^{\circ}$ C

#### Temperature Thermocouple T

Range	-200 to 400 $^{\circ}$ C
Resolution	0.1 $^{\circ}$ C (1 $\mu$ V)
Accuracy	-200 to -50 $^{\circ}$ C $\pm 0.5$ %
	50 to 400 $^{\circ}$ C $\pm 0.5$ %
	-50 to 50 $^{\circ}$ C $\pm 0.5$ %
Cold junction compensation	$\pm 0.3$ $^{\circ}$ C

**Pulse counter (input 1 only)**

Zero crossing detector	
Opto coupler interface	
Range	0 to 65,000 counts
Resolution	1 count
Frequency range	0 to 25 Hz
Input signal	0 – 5 V
Input impedance	470 $\Omega$

**Frequency (input 1 only)**

Zero crossing detector	
Opto coupler interface	
Range	20 to 4,000 Hz
Time resolution	6.5 $\mu$ s
Input signal	0 to 5 V
Input impedance	470 $\Omega$

**Internal Temperature**

NTC – 10K $\Omega$ resistor	
Range	-25 to 70 $^{\circ}$ C
Resolution	0.1 $^{\circ}$ C (1 $\mu$ V)
Accuracy	$\pm$ 0.3 $^{\circ}$ C

**General A to D specifications**

Noise	30 $\mu$ V rms
Internal linearity error	$\pm$ 0.08 % of FSR
Offset error	0.1 %

**Alarm output (output 8)**

Open collector	
Close position resistance	50 $\Omega$
Max. Load	50 mA, 5 VDC
Overload protection	50 mA re-settable fuse

**Communication**

- USB 1.1 compliant

**Sampling**

- Capacity: 512 KB
- Analog sampling rate: Variable, 1 sample per hour to 4,000 samples per second, 1 channel\*
- Analog sampling resolution: 16 bits
- Channel separation 80dB

**Man Machine Interface**

- Full keyboard operation - enables manual programming of the Logger
- Graphic LCD 64 x 128 pixels

**Power Supply**

- Internal rechargeable 7.2 V Ni-MH battery
- Built in battery charger
- External 9 V to 12 VDC input
- Battery life: ~25 hours between charges

**Operating Temperature Range**

- 0 to 50  $^{\circ}$ C

**Casing**

- Plastic ABS box
- Dimensions: 182 x 100 x 28 mm
- Weight: 450 g

**Standards Compliance**

- CE, FCC

---

\* Maximum sampling rate varies with number of used channels (see page 24)

# DaqLab Software

## Main Features

- Graphical, analysis WINDOWS™ based software for the *DaqPRO*
- Fast data download from the *DaqPRO*
- Data displayed in numeric or graphical display forms Graphical display of all inputs
- On-line retrieval and display of data in real-time
- Setup wizard for the *DaqPRO*
- Definition of up to 20 new sensors in the *DaqPRO*
- Ability to read the defined sensor's units on the logger's display
- Full calibration of the *DaqPRO* via software
- Documentation and filing
- Alarm levels on graphs
- Export and import to and from spreadsheets
- More than 30 analytical function, for professional analysis of the collected data
- Manual backup of *DaqPRO* calibration settings

## System Requirements

### Software

- Windows 98 or later
- Internet Explorer 5.0 or later (Internet Explorer 5 can be installed together with DaqLab, since it ships with the product)

### Hardware

- Pentium 200MHz or higher
- 32 MB RAM (64 MB recommended)
- 10 MB available disk space for the DaqLab application (50 MB to install the supporting applications)

### Ordering Information

<b>Part Number</b>	<b>Description</b>
<i>DaqPRO</i> -5300	<i>DaqPRO</i> data logger, user manual, carrying case, AC/DC adapter
SFTDAQ001	DaqLab Windows analysis software, communication cable
11460	Weather box
AC029	12V Solar cell and battery
DT245	220V AC/DC adapter
DT282	220V AC/DC adapter (UK)
DT246	110V AC/DC adapter
DT180	USB communication cable

**To order *DaqPRO* products and accessories:**

Visit [www.fourtec.com](http://www.fourtec.com)

# Appendix: Figures

Figure 1: <i>DaqPRO</i> external connections .....	4
Figure 2: <i>DaqPRO</i> 's inputs block terminal .....	6
Figure 3: Connecting 3-wire PT 100.....	7
Figure 4: Connecting external alarm device .....	8
Figure 5: <i>DaqPRO</i> front panel .....	10
Figure 6: Frequency Aliasing.....	23
Figure 7: DaqLab window layout .....	29
Figure 8: Date format settings dialog box.....	34
Figure 9: Edit graph dialog box.....	40
Figure 10: Setup wizard step 1 of 3.....	47
Figure 11: Setup wizard step 2 of 3.....	48
Figure 12: Setup wizard step 3 of 3.....	48
Figure 13: Alarm settings .....	49
Figure 14: X-axis properties dialog box .....	51
Figure 15: Triggering dialog box.....	52
Figure 16: Edit notes dialog box.....	54
Figure 17: Lost calibration error message .....	55
Figure 18: Loading factory calibration defaults .....	56
Figure 19: Two-point calibration dialog box .....	60
Figure 20: Offset calibration dialog box .....	62
Figure 21: Zero calibration dialog box .....	64
Figure 22: Define New Sensor dialog box .....	65
Figure 23: Communication Setup dialog box.....	66
Figure 24: Analysis wizard – Curve fit.....	70
Figure 25: Analysis wizard – averaging .....	71
Figure 26: Analysis wizard – functions.....	72

# Appendix: Simplified Measurement Circuits

**0 to 10V**

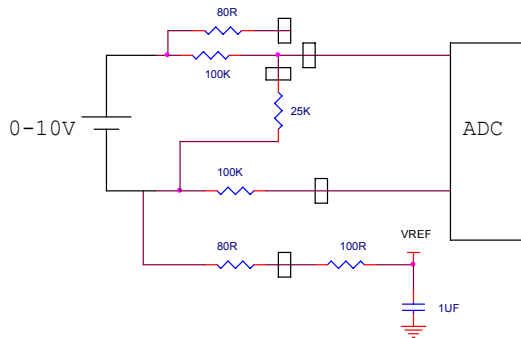

**0 to 24mA**

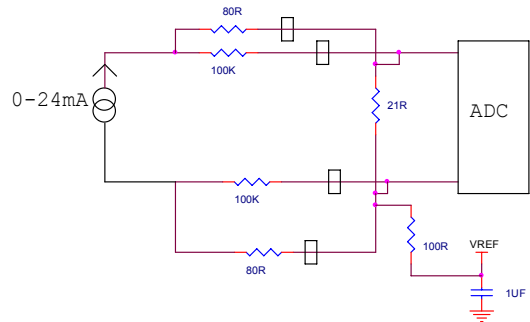

**2 wire PT 100**

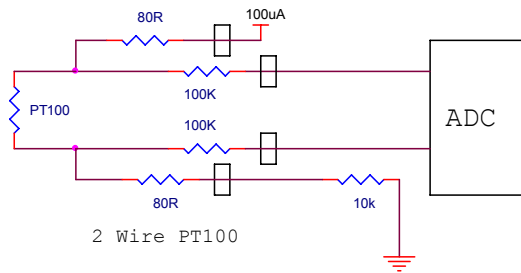

**3 wire PT 100**

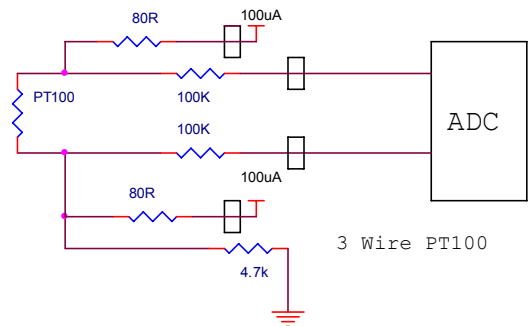

### NTC

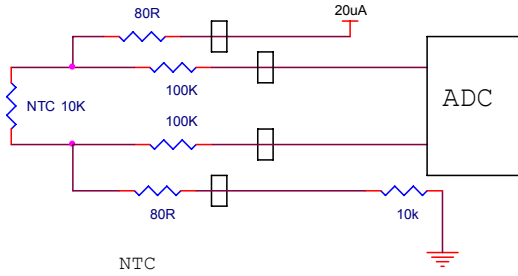

### Internal NTC

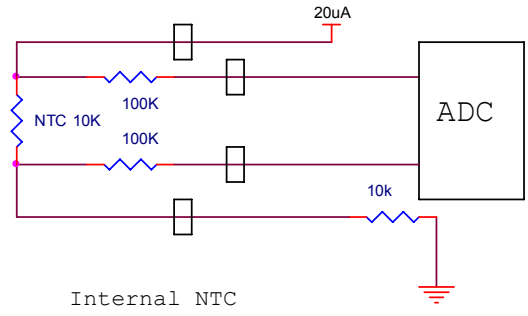

### Thermocouple

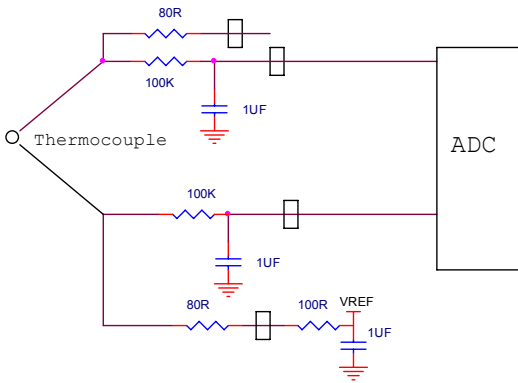



# Index

---

## A

AC/DC adaptor · 9  
alarm · 40  
  level · 8  
  output · 8, 50  
  set · 8  
  setup · 49  
analysis · 67  
  averaging · 71  
  curve fit · 70  
  derivative · 69  
  function · 72  
  integral · 69  
  smoothing · 67  
  wizard · 69  
autoscale · 38  
averaging · 71

---

## B

battery · 9  
  level · 50  
block terminal · 6

---

## C

cable · 3  
calibration · 9, 58  
channels · 5  
chart · See table  
clear  
  data · 44  
  memory · 54

clock  
  internal · 22  
COM port · 66  
comment · 9, 54  
communication · 66  
Compensation · 21, 50  
configuration · 20  
connect · 66  
connection  
  3 wire PT 100 · 6  
  frequency/pulse counter ·  
  6  
  polarity · 6  
  screw terminal · 6  
  to a computer · 5  
continuous · 24, 25  
contrast · 21  
coordinates · 19, 37  
copy · 46  
counter · 6  
crop · 78  
cursor · 19, 37  
curve fit · 68, 70

---

## D

data map · 43  
define  
  custom sensor · 65  
delayed start · See  
  triggering  
delete · 44  
derivative · 69  
display  
  control the display · 44  
  data map · 43  
  graph · 36  
  meters · 43

options · 36  
properties · 51  
select · 14  
table · 42  
download · 31

---

## E

edit  
  graph · 39  
  notes · 55  
enter · 13, 16  
escape · 16  
event · 8  
event recording · 53  
Excel · 45  
export · 45  
external power · 5

---

## F

filter · 21  
format  
  graph · 41  
  table · 42  
frequency · 6  
functions · 72

---

## G

getting started · 30  
graph · 18, 36

---

## I

icon · 16  
Illegal sensor · 7  
import · 33  
input · 5  
integral · 69

---

## K

keypad · 10

---

## L

layout  
    DaqLab · 29  
    DaqPRO · 10  
load  
    last setup · 20  
    notes · 54, 55

---

## M

mains adaptor · 9  
manual  
    sampling · 23  
memory · 25  
    clear · 21, 54  
menu · 15  
meter · 17, 43

---

## N

noise · 21, 50  
notes · 55  
number  
    format · 41, 42

of samples · 13, 16, 49

---

## O

online  
    communication · 31  
open · 33  
output · 8, 50

---

## P

panel · 10  
panning · 39  
Password · 59  
polarity · 6  
power · 5  
preset · 51  
print  
    graph · 35  
    table · 35  
program  
    DaqPRO · 47  
programming  
    rules · 24  
project · 28, 33  
properties  
    graph · 41  
    table · 42  
PT 100  
    3 wire · 6  
PT 100 · 6  
pulse · 6

---

## R

rate · 13, 16, 22, 24, 48, 83  
recharge · 9  
recording  
    data · 14, 30

options · 31  
rate · See rate  
start · 54  
stop · 54  
time · 13, 16, 49  
regression · See curve fit  
requirements · 26  
run · 30, 54

---

## S

sampling Points · 23  
sampling rate · See rate  
save · 32  
scale · 39  
screen contrast · 21  
scroll · 48  
sensor · 5, 6, 11  
    assign to input · 47  
    calibration · 58  
    custom · 65  
    plug in · 11  
serial number · 9  
setup · 11, 16, 20, 22, 47  
slope · See derivative  
smoothing · 67  
specifications · 84  
spreadsheet · 45  
stand alone · 10  
start · 14, 16, 30  
stop · 14, 16, 30  
system configuration · 20

---

## T

table · 42  
temperature  
    units · 21, 55  
terminal · 6  
timer delay · 53  
toolbar

graph · 80  
main · 79  
triggering · 52  
trim · See crop  
troubleshooting · 82

---

## U

units  
format · 41, 42  
temperature · 21

---

## V

value · 19, 37  
view · 36

---

## W

wizard  
analysis · 69  
setup · 47

---

## X

X-axis · 40, 51

---

## Y

Y-axis · 36, 40

---

## Z

zoom · 19, 38